

BAGATELLE 1238N- ___ _H













8 + 3 Lights
Diameter: 26-1/2"
Body Length: 24-1/2"
Hanging Weight: 23lbs.

THIS DESIGN IS THE PROPRIETARY TRADE DRESS/TRADEMARK OF W SCHONBEK LLC.

 **SCHONBEK** | 1870

 **SCHONBEK** | 1870

								
8 X MAX 60 W		3 X MAX 40 W		110-120 V				

All electrical components must be installed by a licensed electrician in accordance with the National Electric Code and the appropriate local electrical codes.

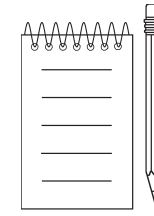
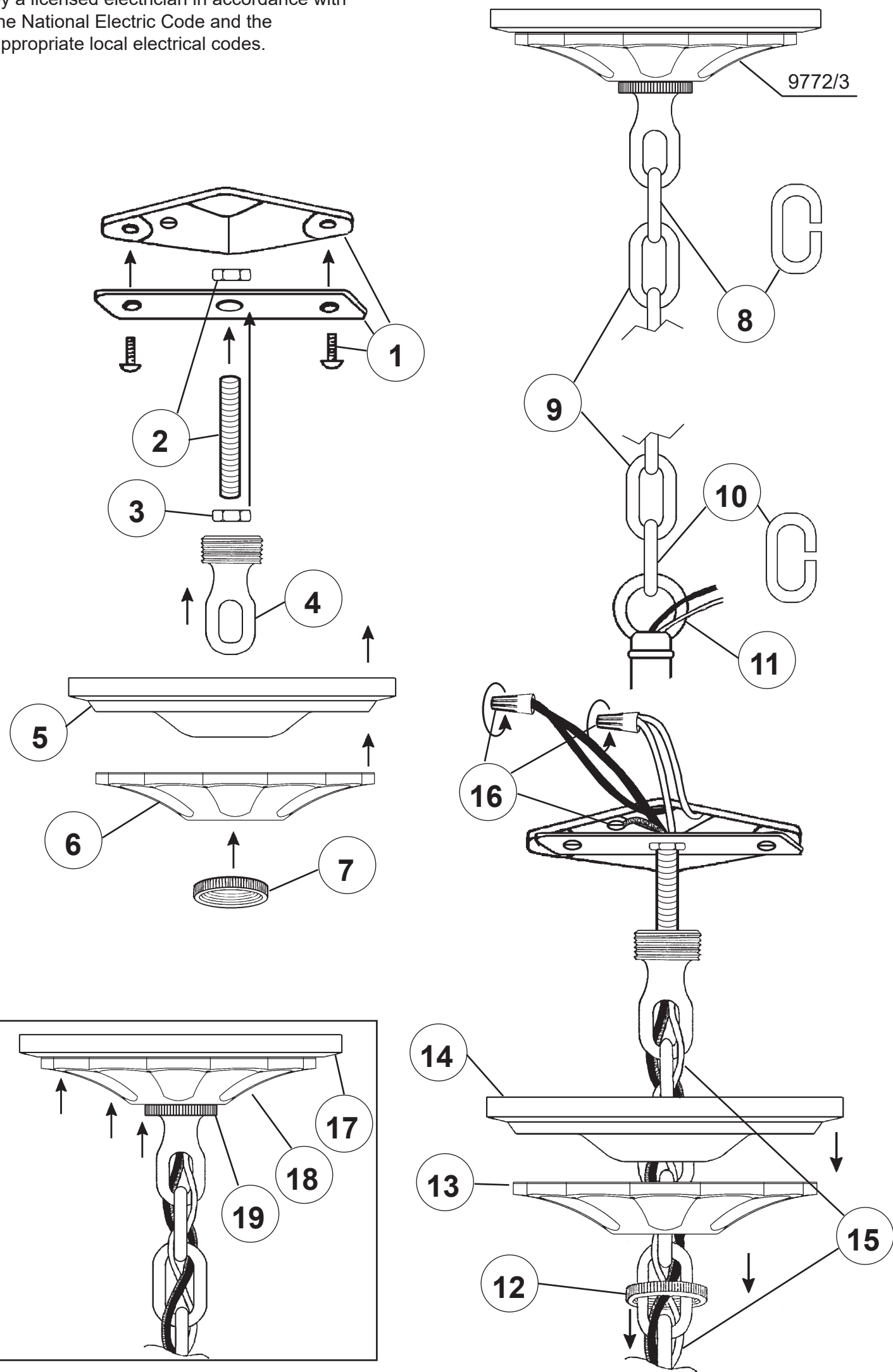

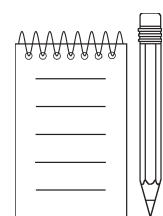
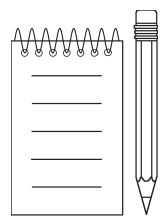

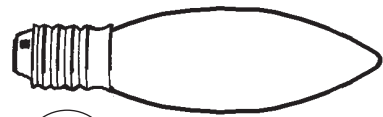

20

You will need 8 - B10
25 Watts Recommended
60 Watts Max

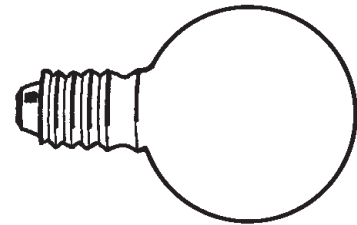

3 - G12
25 Watts Recommended (supplied)
40 Watts Max

Install bulbs and be sure
to test fixture **BEFORE**
trimming.

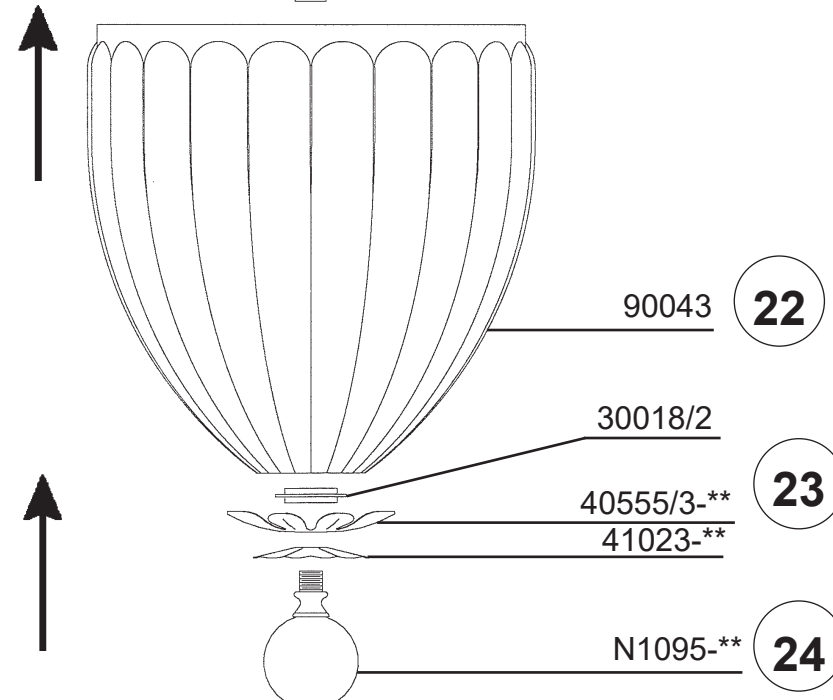
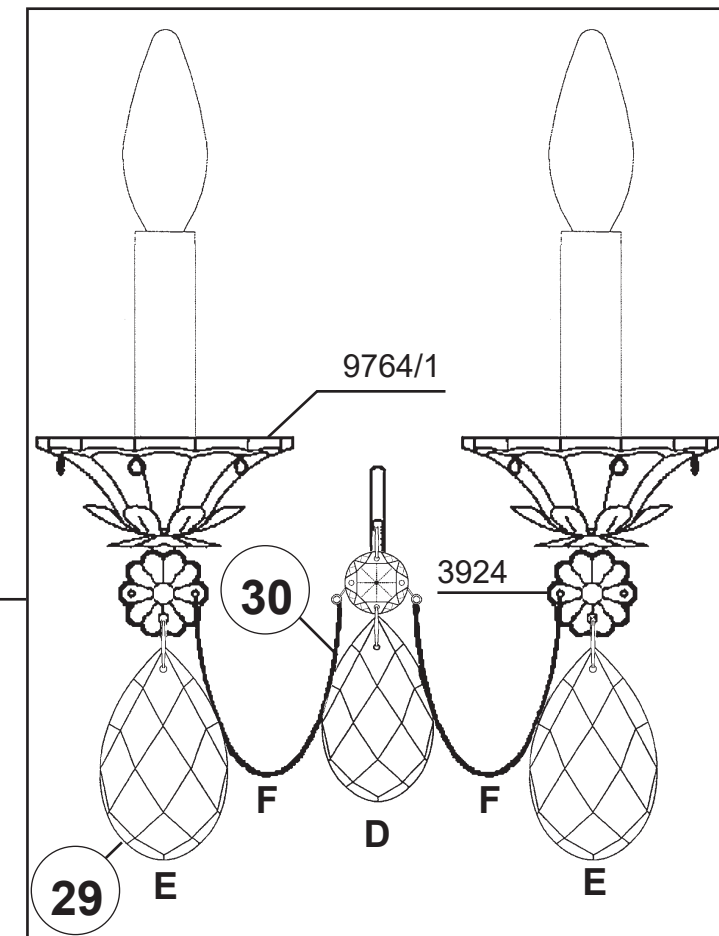
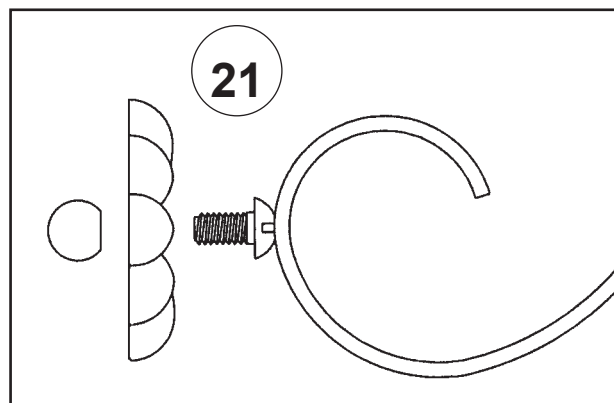
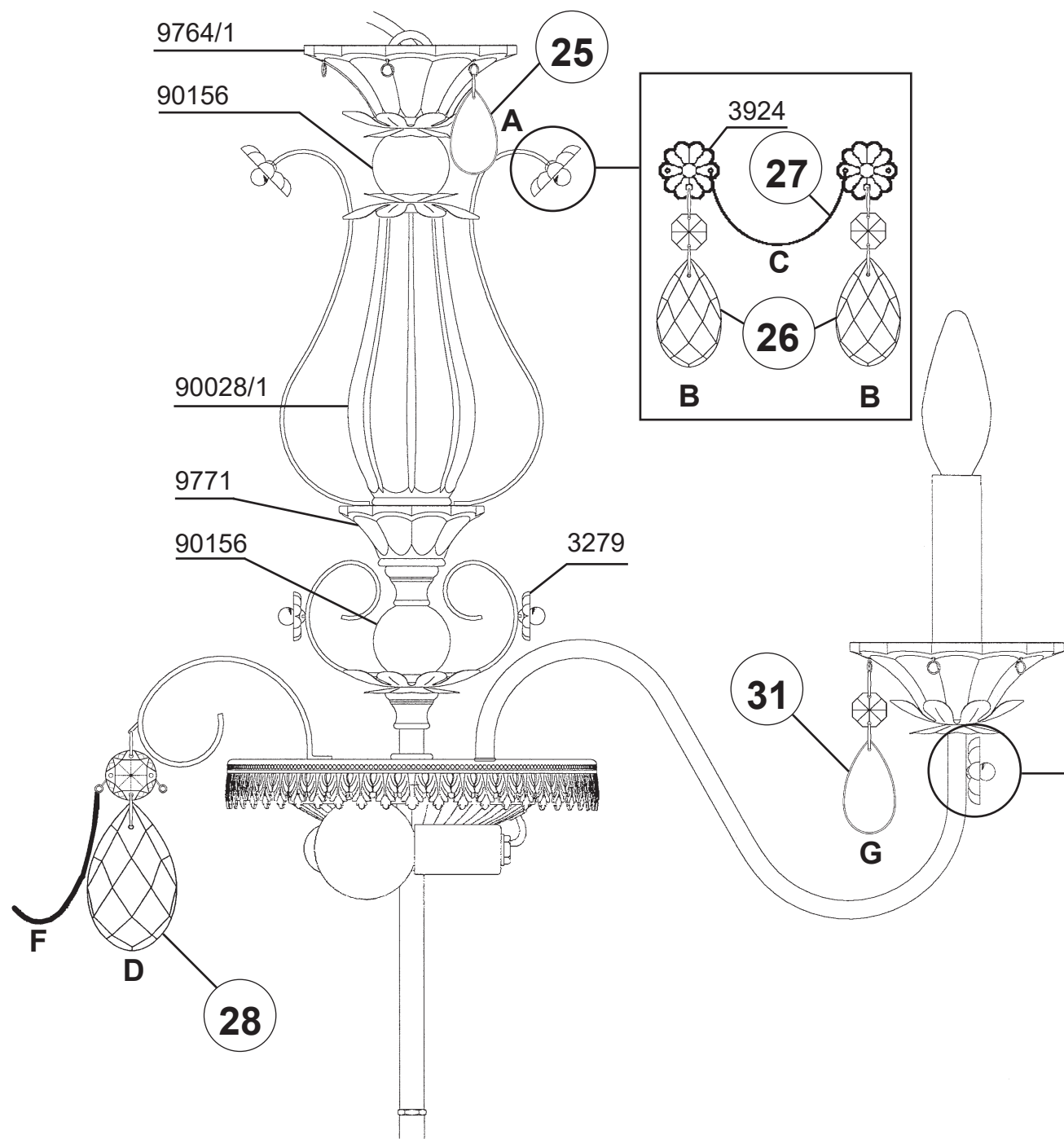

BAGATELLE 1238N-__ __R













8 + 3 Lights
Diameter: 26-1/2"
Body Length: 24-1/2"
Hanging Weight: 23lbs.

THIS DESIGN IS THE PROPRIETARY
TRADE DRESS/TRADEMARK OF
W SCHONBEK LLC.

 **SCHONBEK** | 1870

 **SCHONBEK** | 1870

								
8 X MAX 60 W		3 X MAX 40 W		110-120 V				

All electrical components must be installed by a licensed electrician in accordance with the National Electric Code and the appropriate local electrical codes.

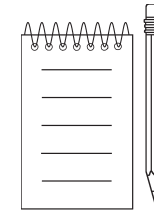
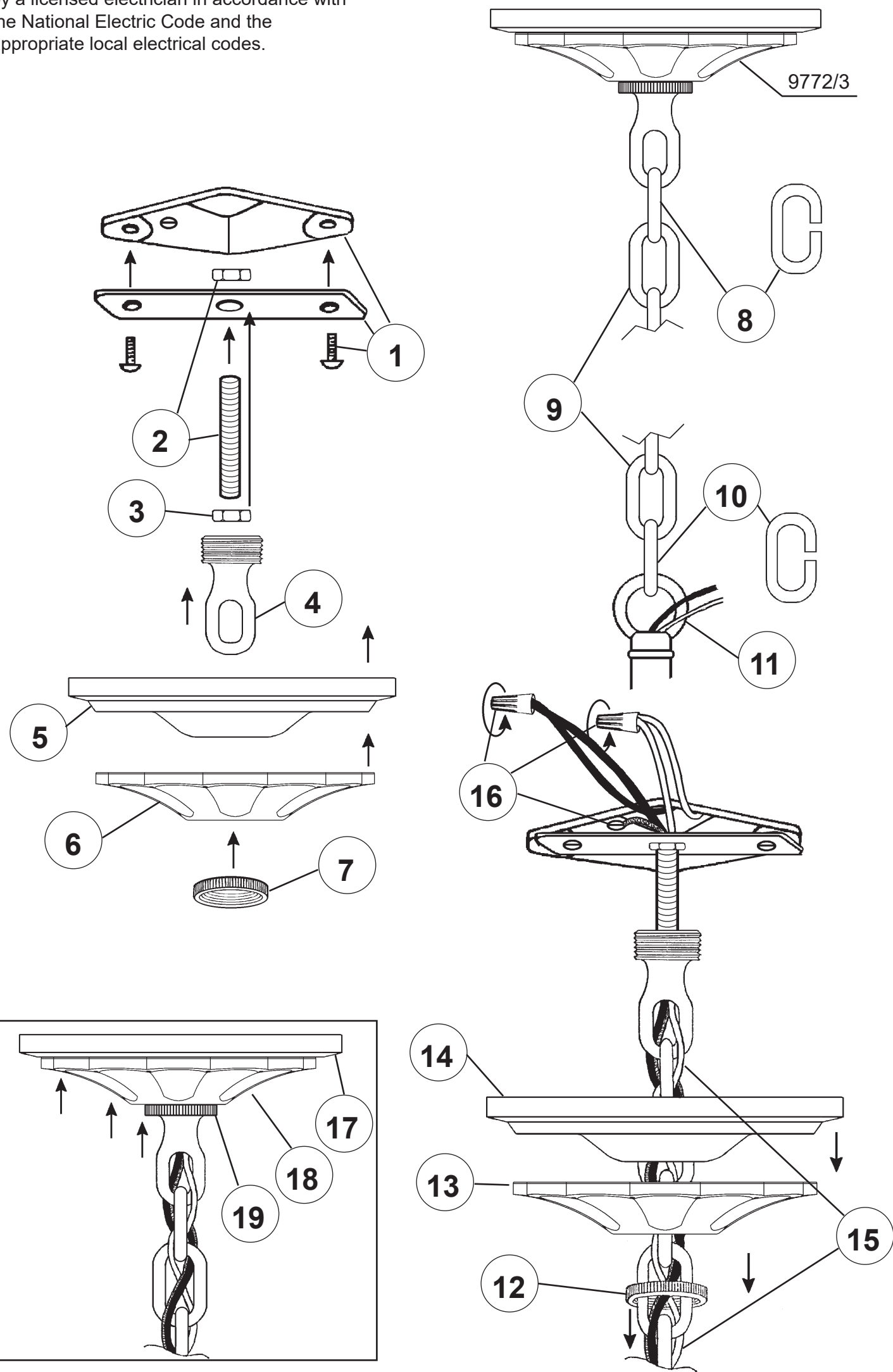

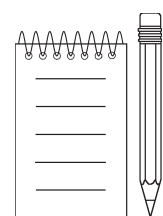
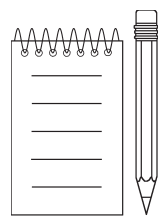

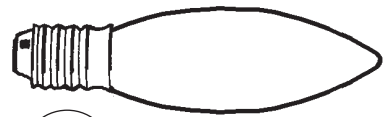

20

You will need 8 - B10
25 Watts Recommended
60 Watts Max

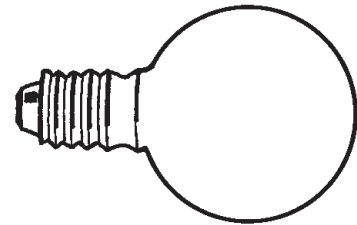

3 - G12
25 Watts Recommended (supplied)
40 Watts Max

Install bulbs and be sure
to test fixture **BEFORE**
trimming.

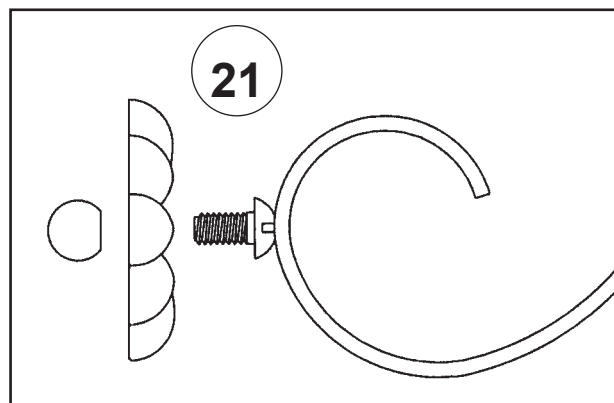
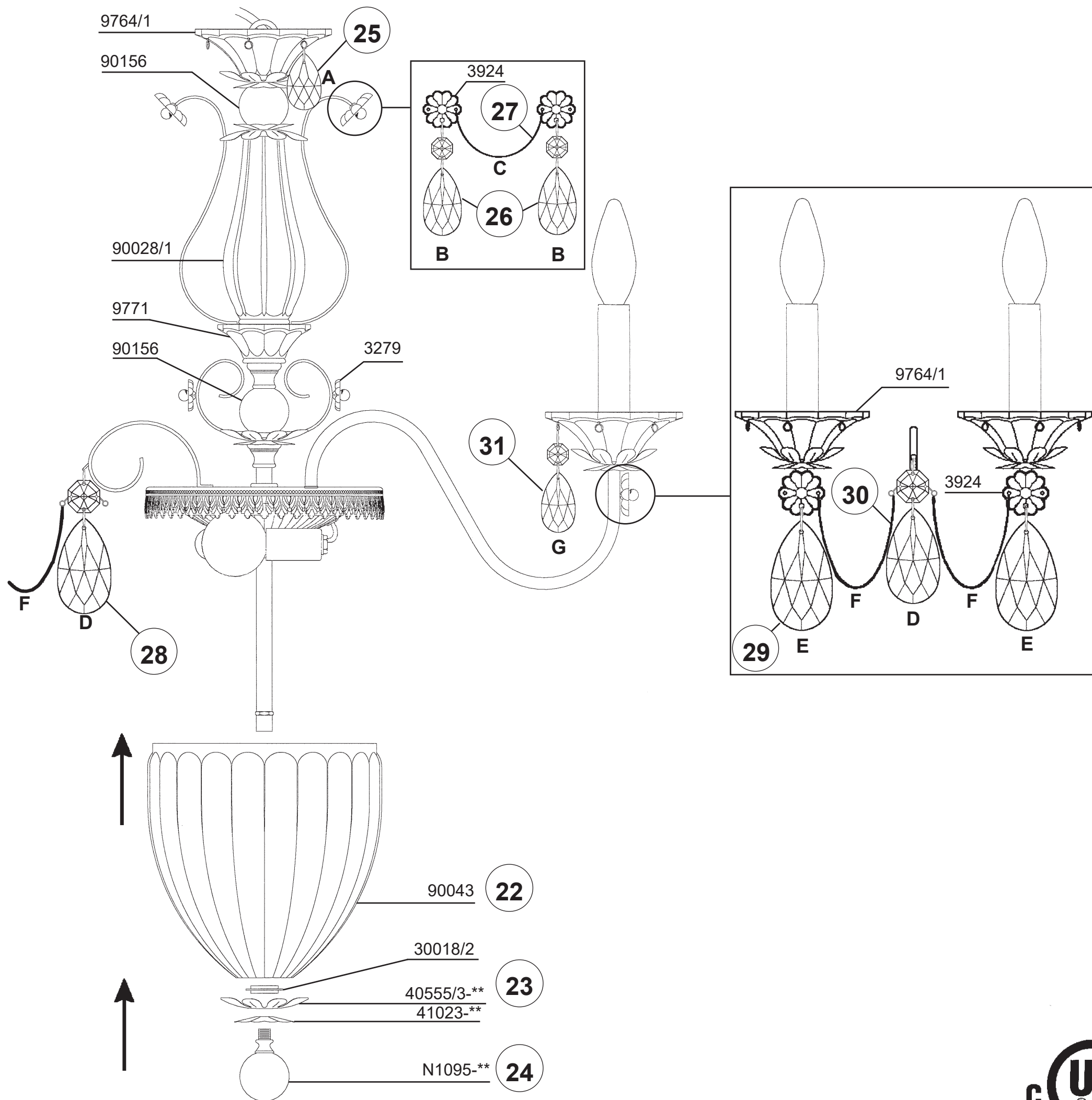

BAGATELLE 1238N- ___ S













8 + 3 Lights
Diameter: 26-1/2"
Body Length: 24-1/2"
Hanging Weight: 23lbs.

THIS DESIGN IS THE PROPRIETARY
TRADE DRESS/TRADEMARK OF
W SCHONBEK LLC.

 **SCHONBEK** | 1870

 **SCHONBEK** | 1870

								
8 X MAX 60 W		3 X MAX 40 W		110-120 V				

All electrical components must be installed by a licensed electrician in accordance with the National Electric Code and the appropriate local electrical codes.

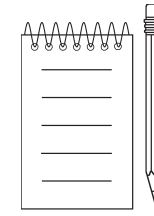
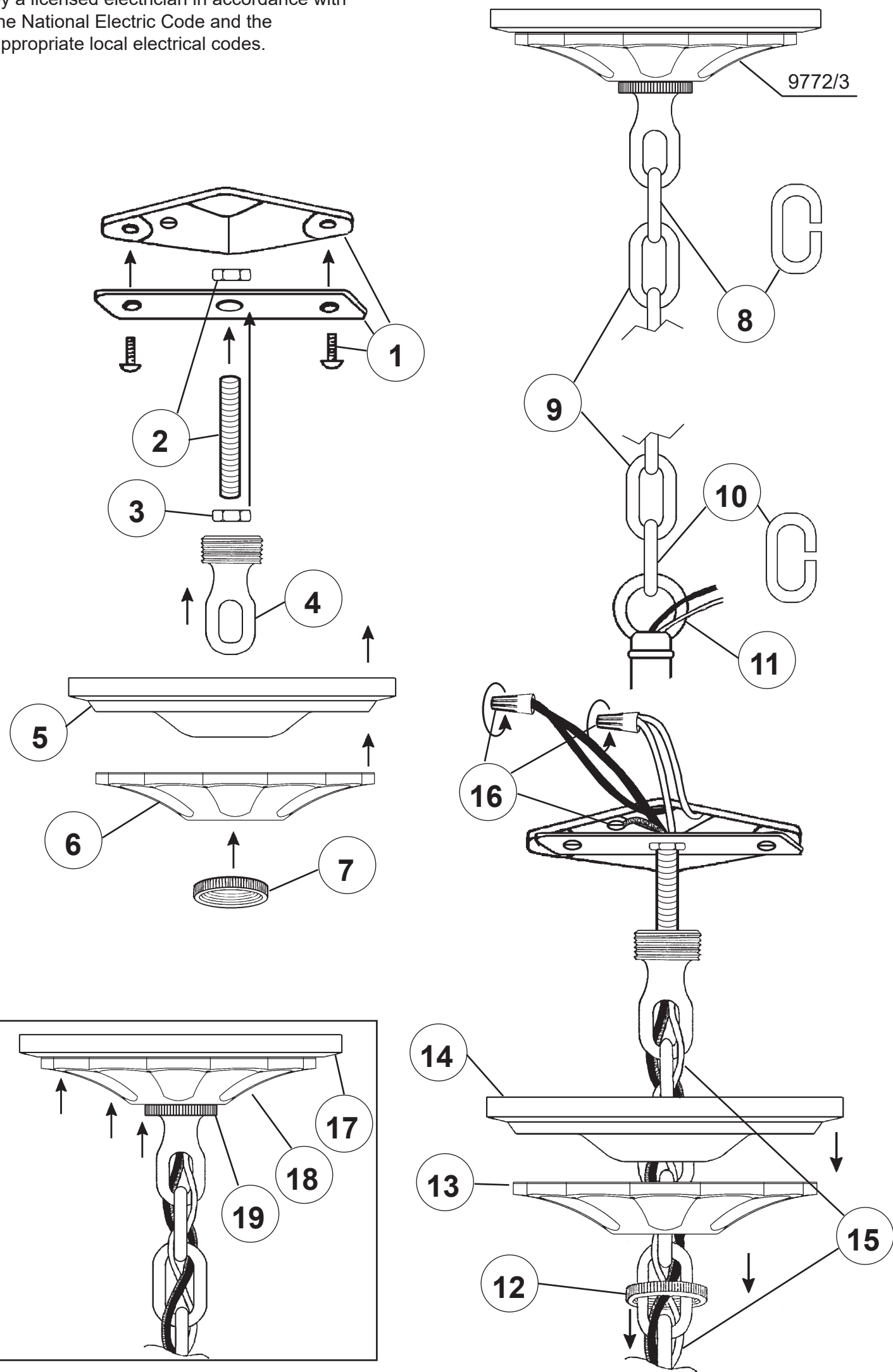

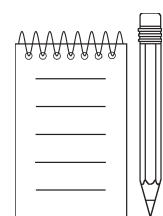
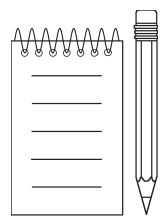

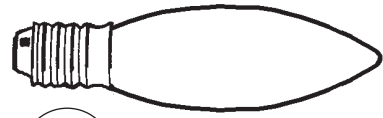

20

You will need 8 - B10
25 Watts Recommended
60 Watts Max

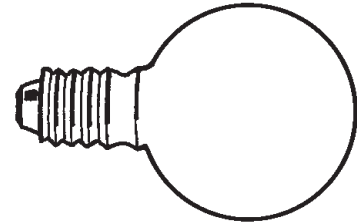

3 - G12
25 Watts Recommended (supplied)
40 Watts Max

Install bulbs and be sure
to test fixture BEFORE
trimming.

