

BAGATELLE 1239- _ _ _

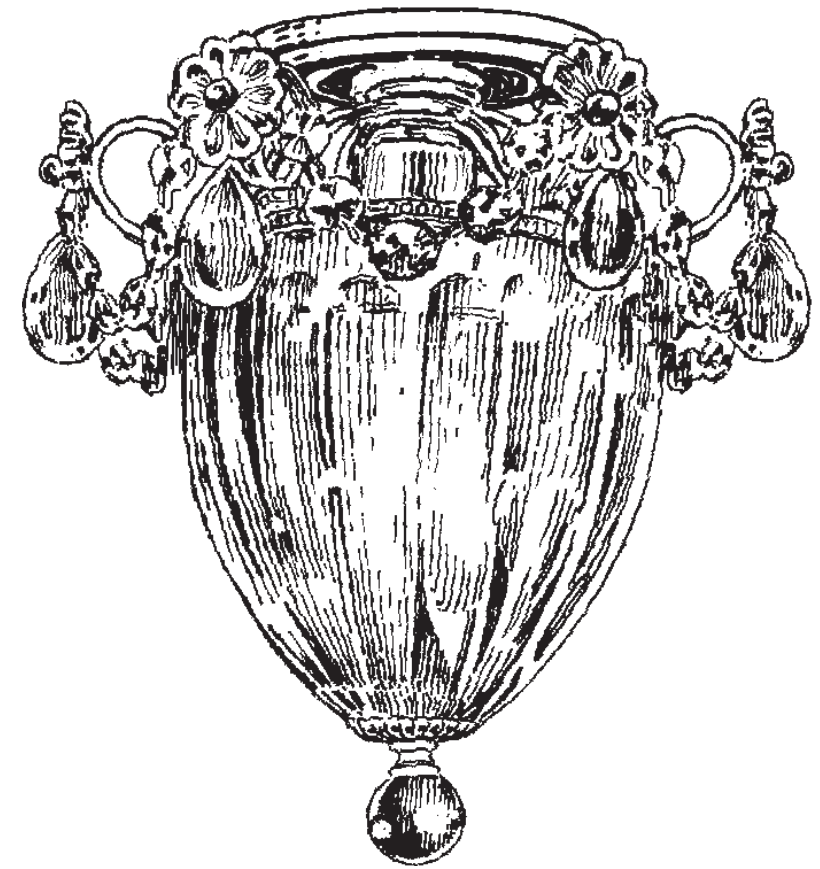











1 Light
Diameter: 8"
Body Length: 9-1/2"
Hanging Weight: 3-1/2 lbs.

THIS DESIGN IS THE PROPRIETARY
TRADE DRESS/TRADEMARK OF
W SCHONBEK LLC.

 **SCHONBEK** | 1870

 **SCHONBEK** | 1870

								
MAX 100 W		110-120 V						

All electrical components must be installed by a licensed electrician in accordance with the National Electric Code and the appropriate local electrical codes.

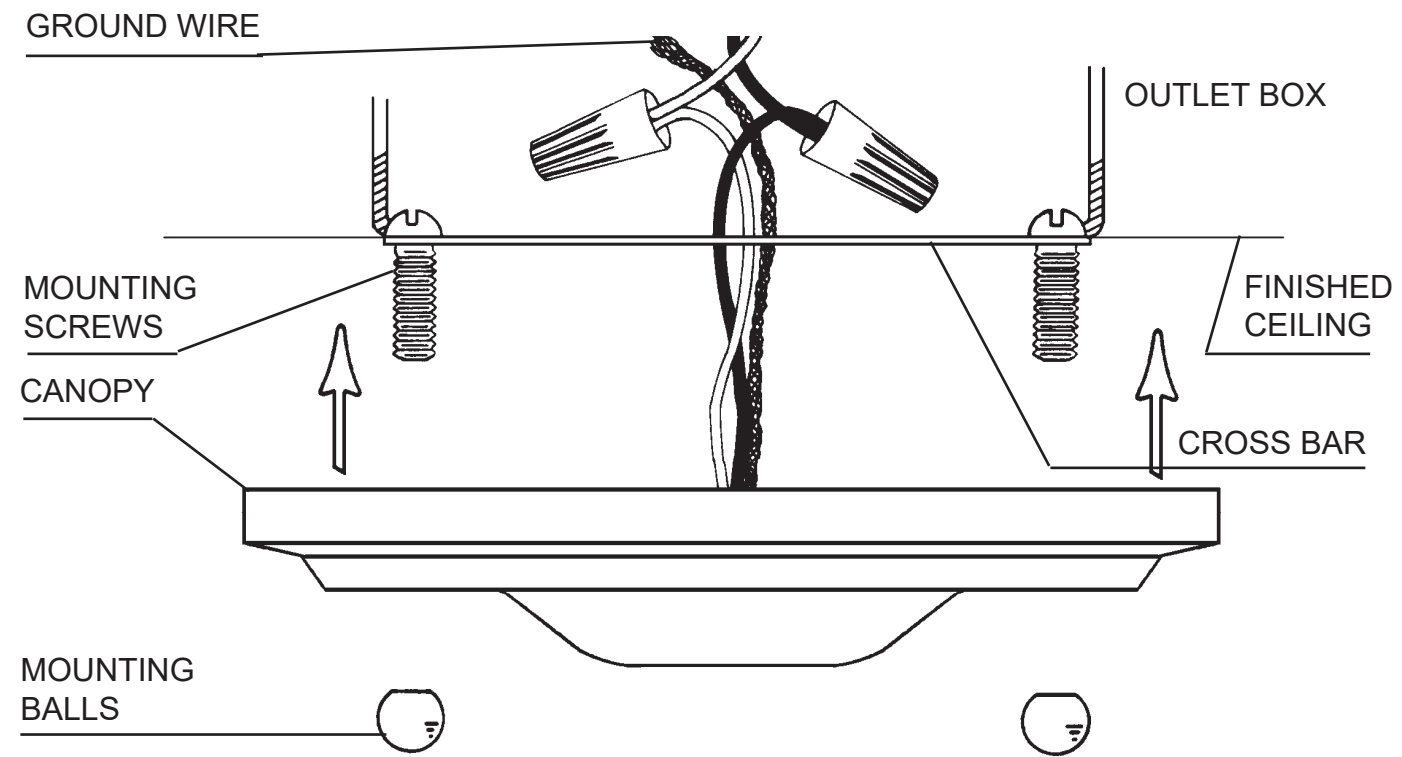

- 1** Attach cross bar to outlet box.
- 2** Again, make sure that power to the outlet box is disconnected. Feed stem wires through cross bar and attach to power wires in outlet box. Fixture **MUST** be properly grounded.
- 3** Attach canopy to ceiling with mounting balls, thereby retaining complete fixture against ceiling.
- 4** Screw bulb into socket. Test power to insure proper wiring before hanging trim from fixture.

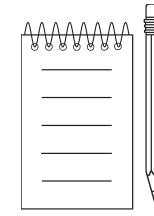



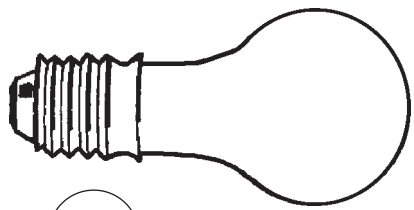

5

You will need 1 - Type A19
40 Watts Recommended
100 Watts Max
MIN 75°C SUPPLY
CONDUCTORS

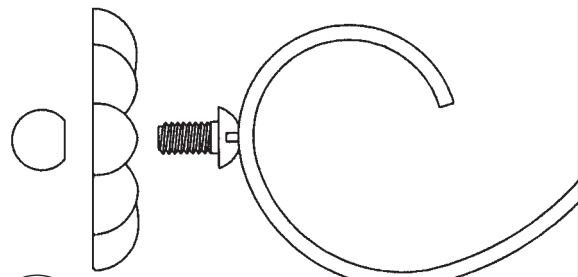

6

Slide rosettes with flat side
facing towards you onto
the screws and secure with
balls provided.

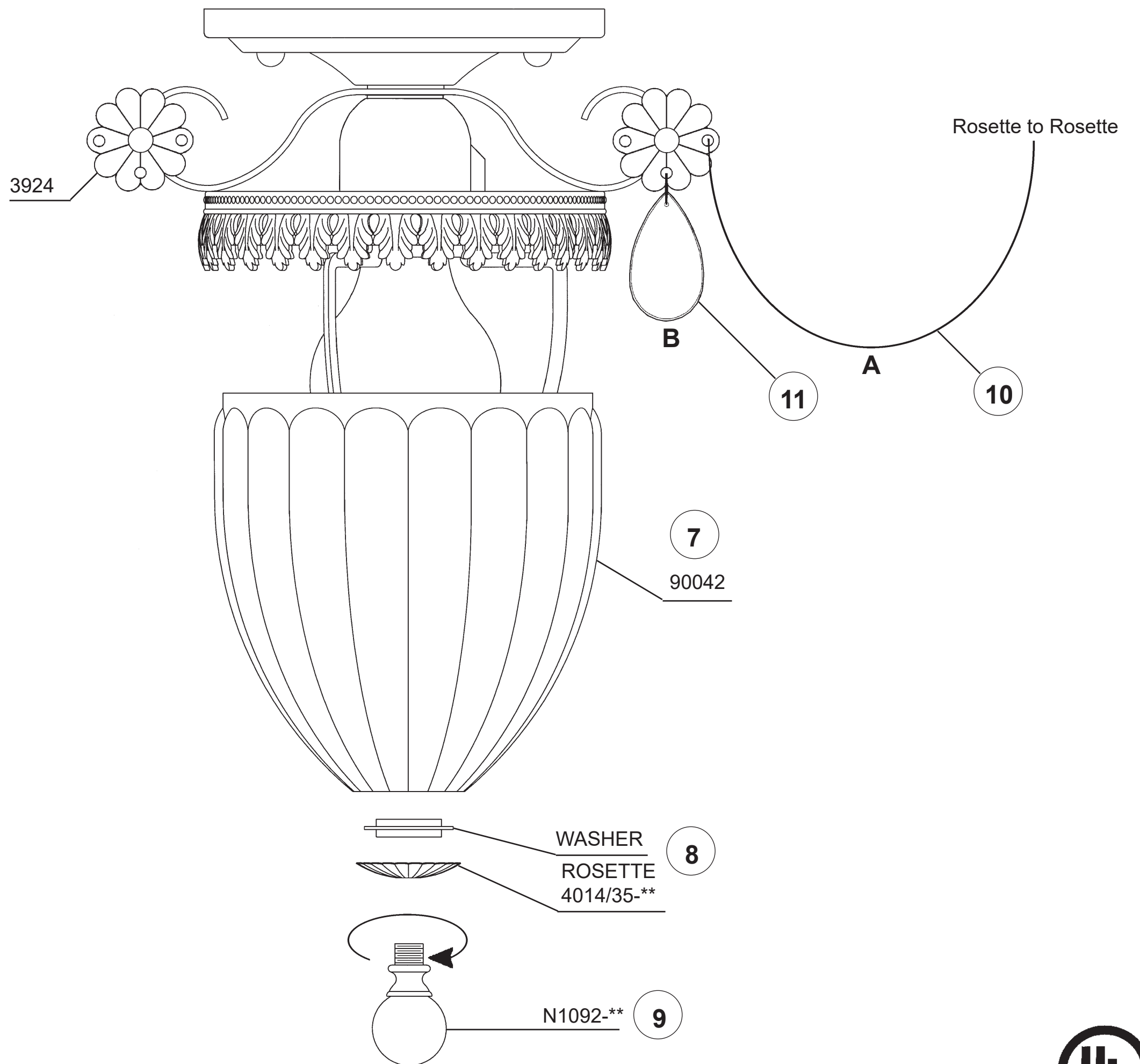

BAGATELLE 1239-__ __R

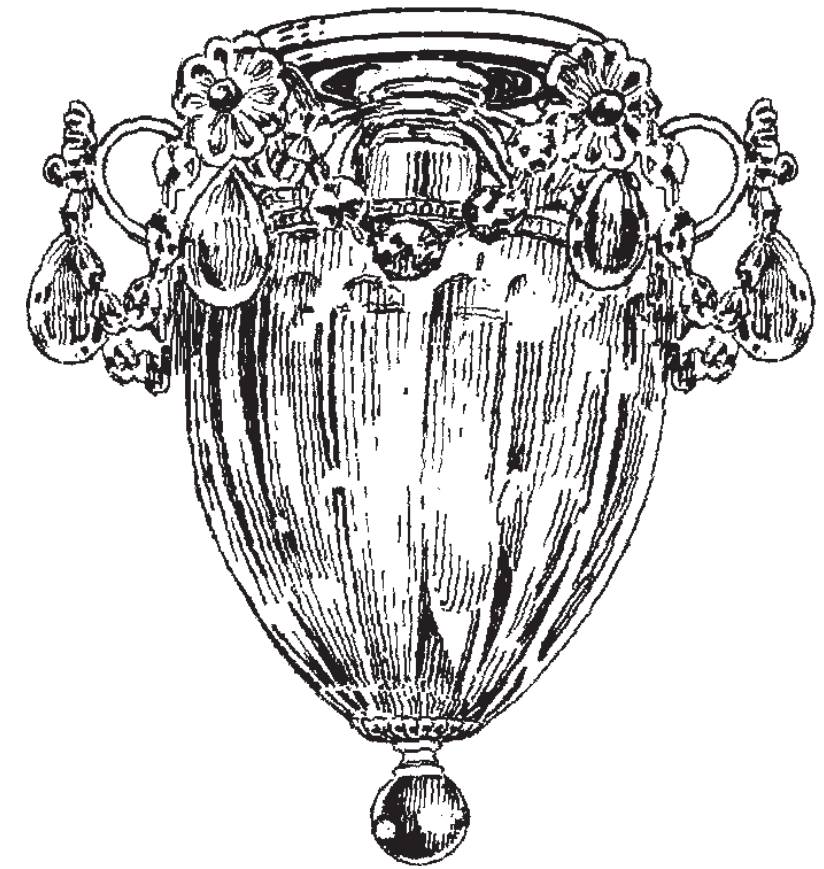

1 Light
Diameter: 8"
Body Length: 9-1/2"
Hanging Weight: 3-1/2 lbs.

THIS DESIGN IS THE PROPRIETARY
TRADE DRESS/TRADEMARK OF
W SCHONBEK LLC.

 **SCHONBEK** | 1870

 **SCHONBEK** | 1870

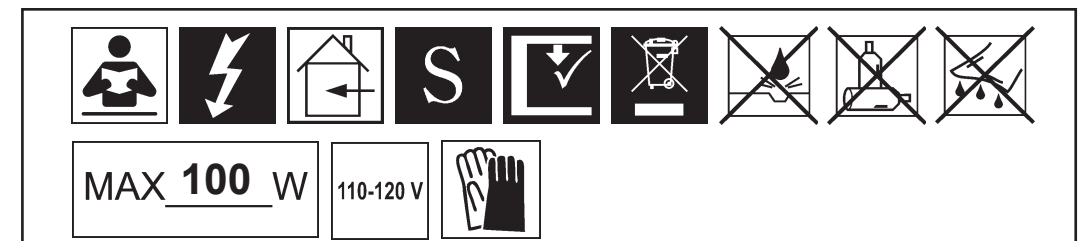

All electrical components must be installed by a licensed electrician in accordance with the National Electric Code and the appropriate local electrical codes.

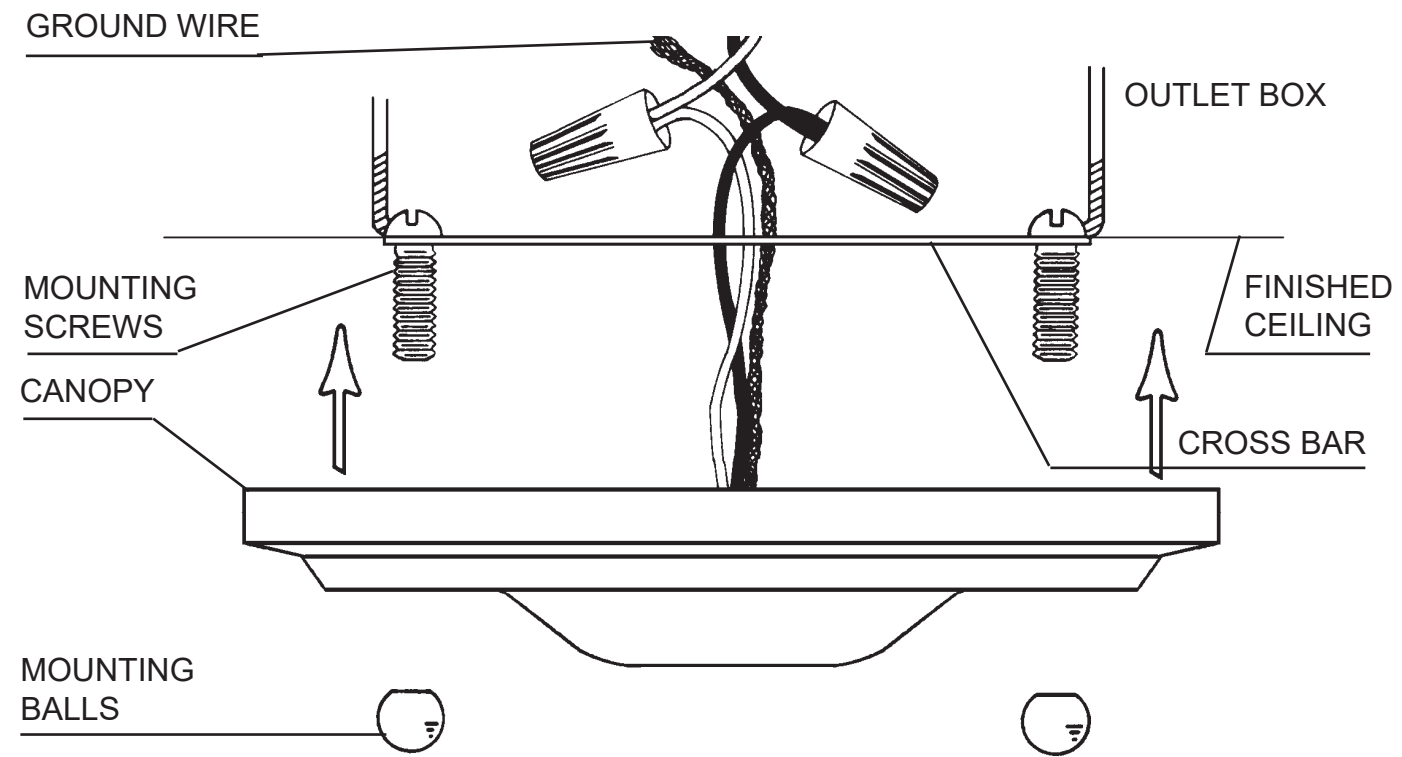

- 1** Attach cross bar to outlet box.
- 2** Again, make sure that power to the outlet box is disconnected. Feed stem wires through cross bar and attach to power wires in outlet box. Fixture **MUST** be properly grounded.
- 3** Attach canopy to ceiling with mounting balls, thereby retaining complete fixture against ceiling.
- 4** Screw bulb into socket. Test power to insure proper wiring before hanging trim from fixture.

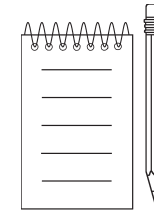

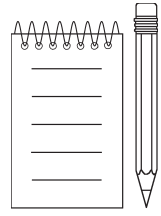

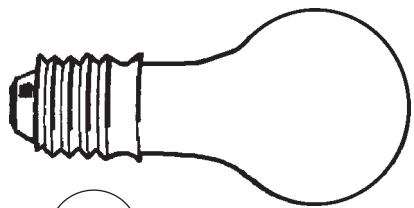

5

You will need 1 - Type A19
40 Watts Recommended
100 Watts Max
MIN 75°C SUPPLY
CONDUCTORS

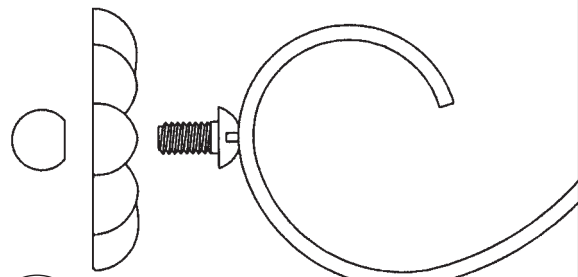

6

Slide rosettes with flat side
facing towards you onto
the screws and secure with
balls provided.

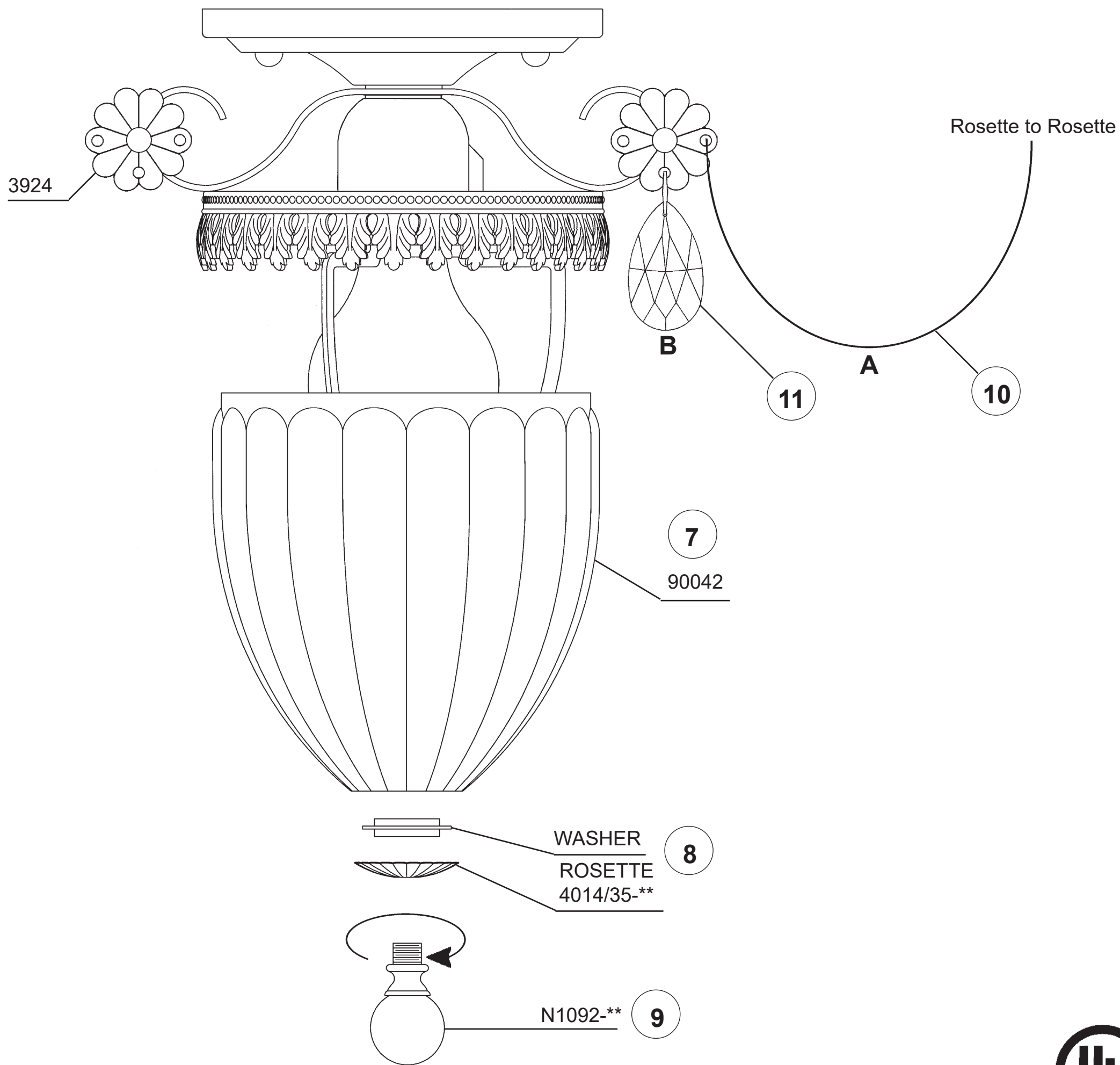

BAGATELLE 1239- _____

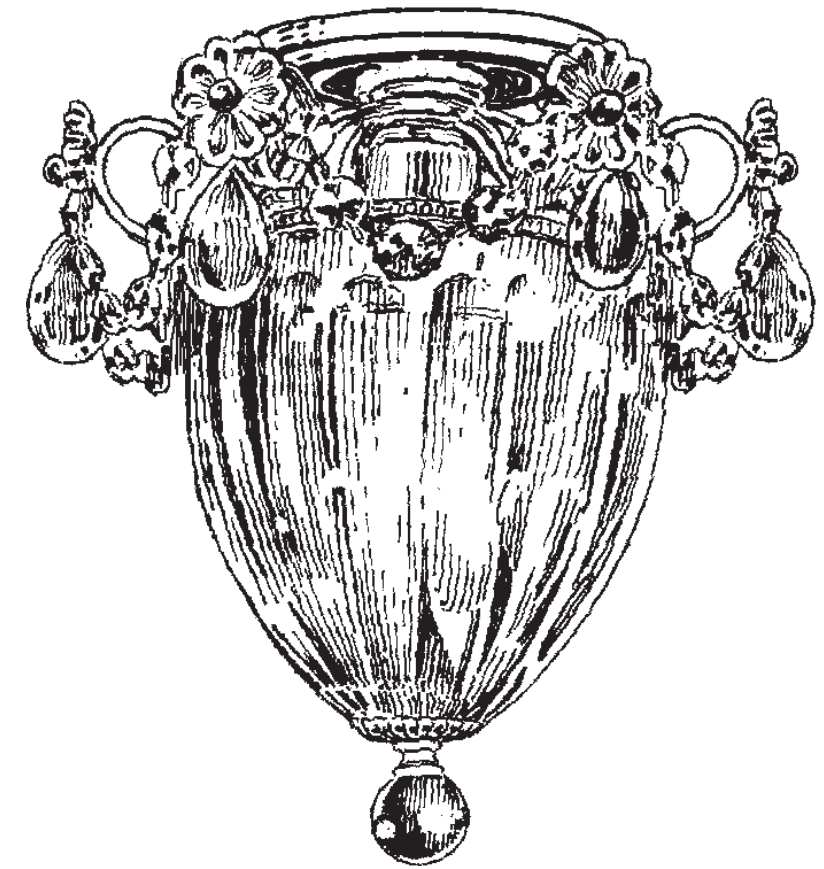











1 Light
Diameter: 8"
Body Length: 9-1/2"
Hanging Weight: 3-1/2 lbs.

THIS DESIGN IS THE PROPRIETARY
TRADE DRESS/TRADEMARK OF
W SCHONBEK LLC.

 **SCHONBEK** | 1870

 **SCHONBEK** | 1870

								
MAX 100 W		110-120 V						

All electrical components must be installed by a licensed electrician in accordance with the National Electric Code and the appropriate local electrical codes.

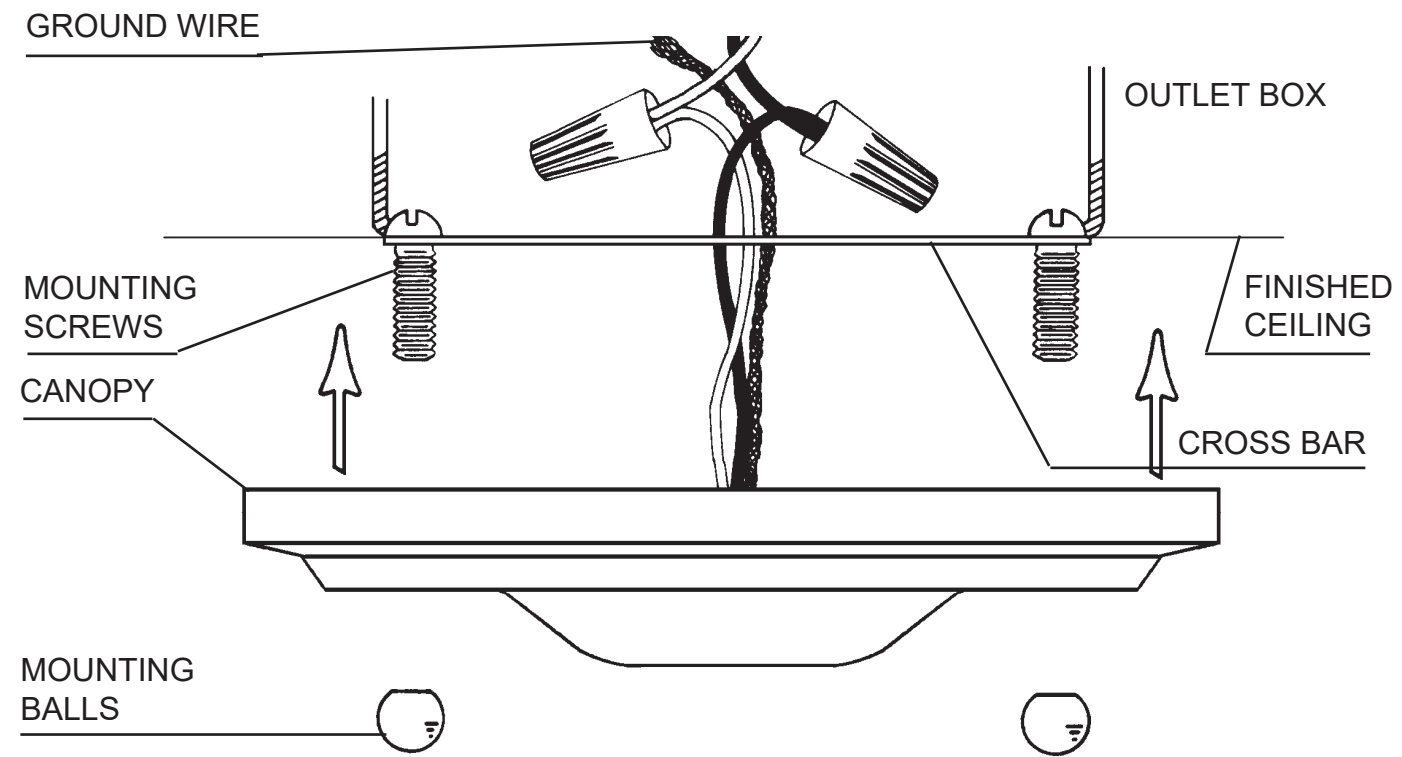

- 1** Attach cross bar to outlet box.
- 2** Again, make sure that power to the outlet box is disconnected. Feed stem wires through cross bar and attach to power wires in outlet box. Fixture **MUST** be properly grounded.
- 3** Attach canopy to ceiling with mounting balls, thereby retaining complete fixture against ceiling.
- 4** Screw bulb into socket. Test power to insure proper wiring before hanging trim from fixture.

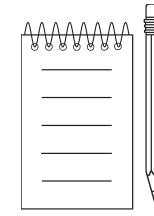



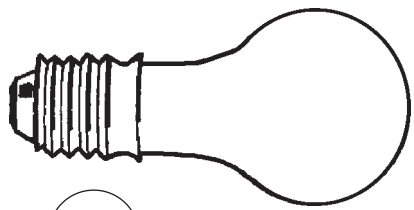

5

You will need 1 - Type A19
40 Watts Recommended
100 Watts Max
MIN 75°C SUPPLY
CONDUCTORS

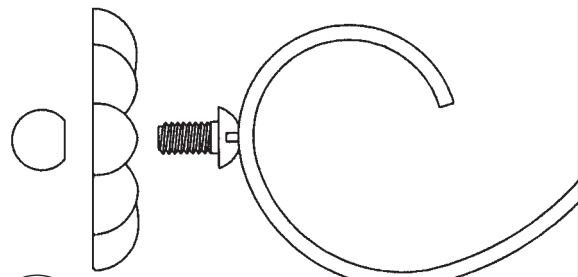

6

Slide rosettes with flat side
facing towards you onto
the screws and secure with
balls provided.

