

BAGATELLE 1242- _ _ _













THIS DESIGN IS THE PROPRIETARY
TRADE DRESS/TRADEMARK OF
W SCHONBEK LLC.

3 Lights
Diameter: 10-1/2"
Body Length: 12"
Hanging Weight: 8 lbs.

 **SCHONBEK** | 1870

 **SCHONBEK** | 1870

								
MAX 40 W		110-120 V						

All electrical components must be installed by a licensed electrician in accordance with the National Electric Code and the appropriate local electrical codes.

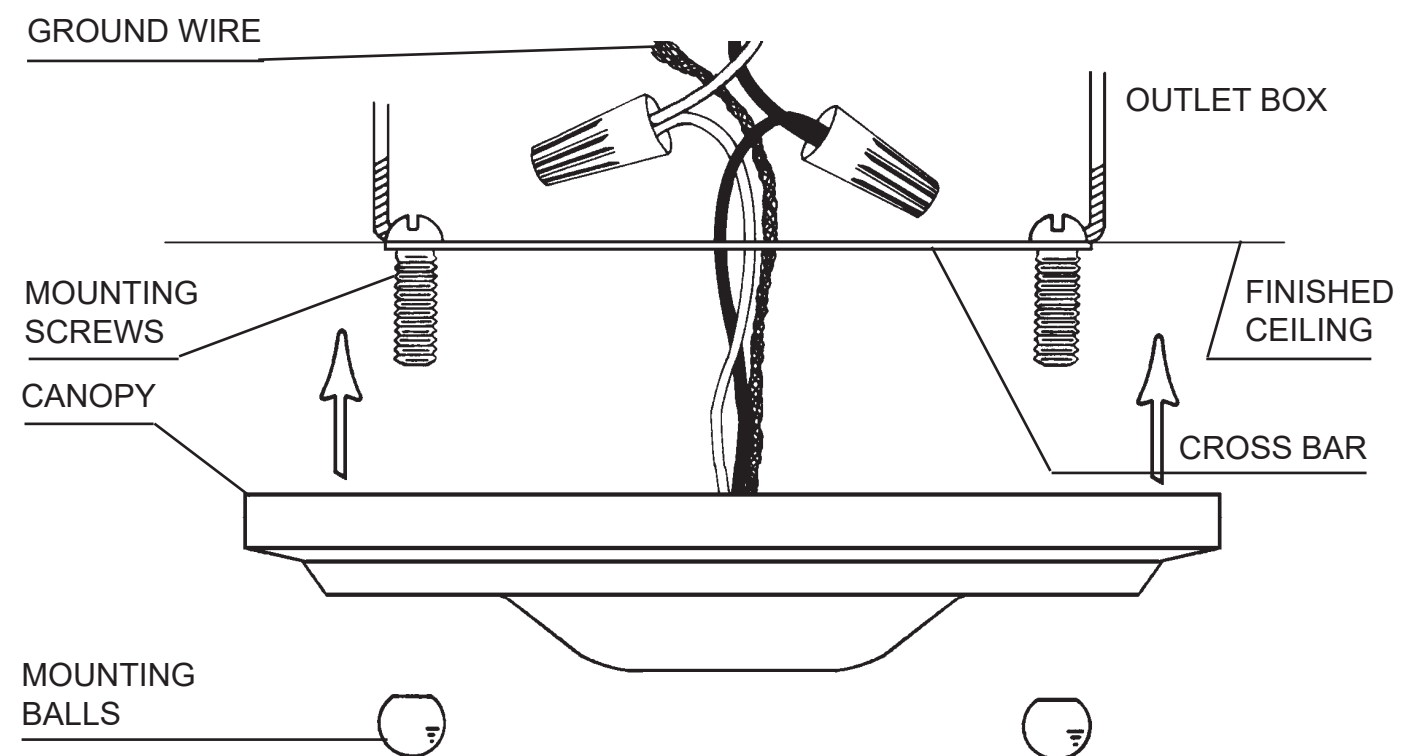

- 1** Attach cross bar to outlet box.
- 2** Again, make sure that power to the outlet box is disconnected. Feed stem wires through cross bar and attach to power wires in outlet box. Fixture **MUST** be properly grounded.
- 3** Attach canopy to ceiling with mounting balls, thereby retaining complete fixture against ceiling.
- 4** Screw bulb into socket. Test power to insure proper wiring before hanging trim from fixture.

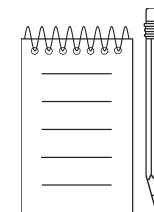



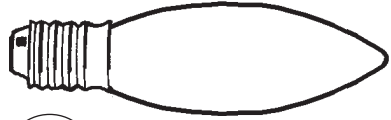

5

You will need 3 - B10
25 Watts Recommended
40 Watts Max
MIN 75°C SUPPLY
CONDUCTORS

Install bulbs and be sure
to test fixture **BEFORE**
trimming.

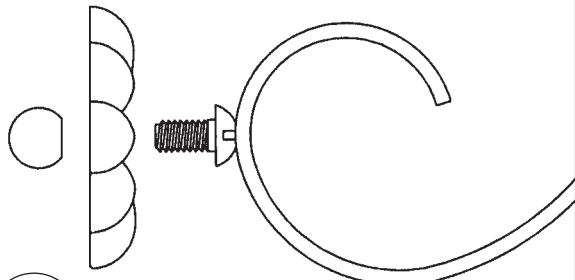

6

Slide rosettes with flat side
facing towards you onto
the screws and secure with
balls provided.

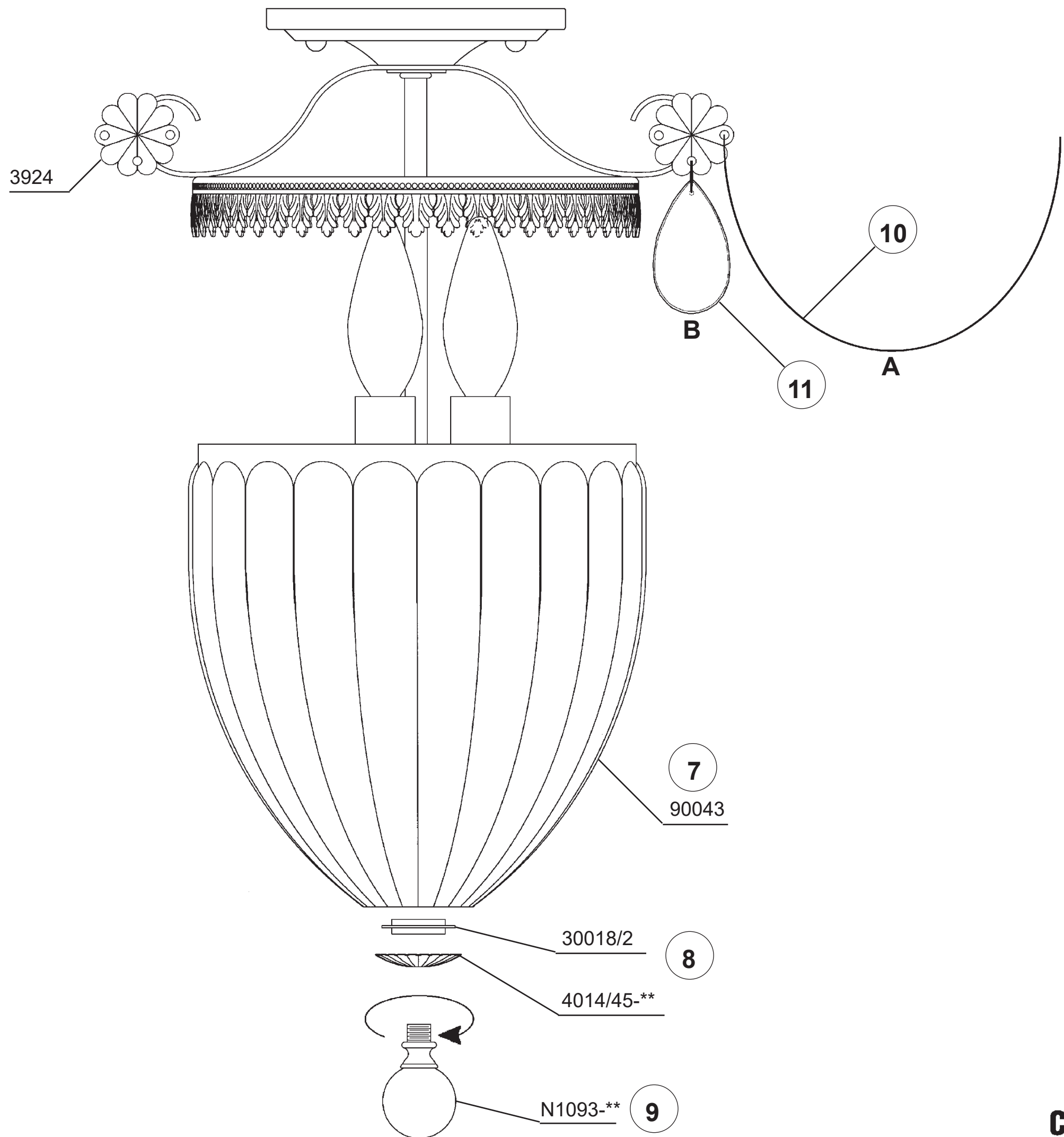

BAGATELLE 1242-__ __R













THIS DESIGN IS THE PROPRIETARY TRADE DRESS/TRADEMARK OF W SCHONBEK LLC.

3 Lights
Diameter: 10-1/2"
Body Length: 12"
Hanging Weight: 8 lbs.

 **SCHONBEK** | 1870

 **SCHONBEK** | 1870

								
MAX 40 W		110-120 V						

All electrical components must be installed by a licensed electrician in accordance with the National Electric Code and the appropriate local electrical codes.

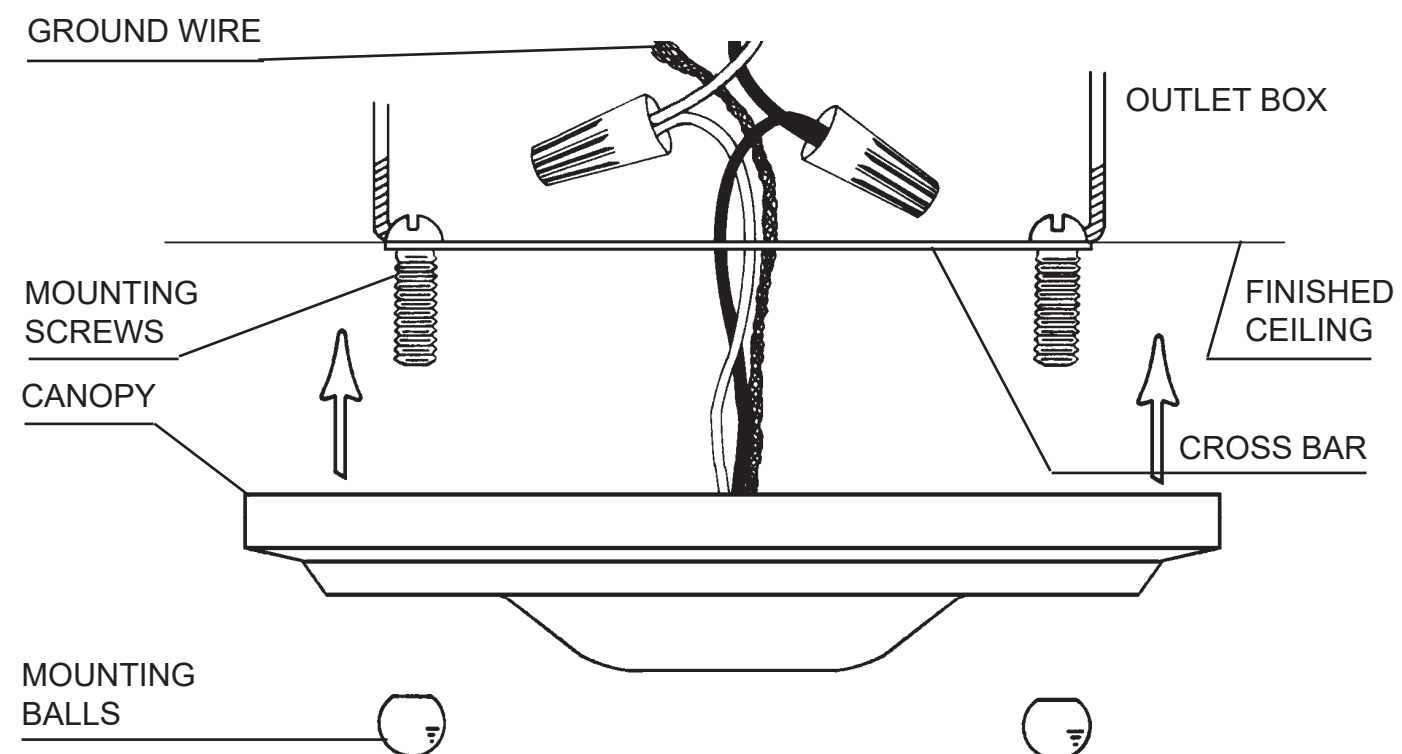

- 1** Attach cross bar to outlet box.
- 2** Again, make sure that power to the outlet box is disconnected. Feed stem wires through cross bar and attach to power wires in outlet box. Fixture **MUST** be properly grounded.
- 3** Attach canopy to ceiling with mounting balls, thereby retaining complete fixture against ceiling.
- 4** Screw bulb into socket. Test power to insure proper wiring before hanging trim from fixture.

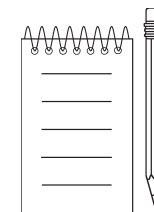

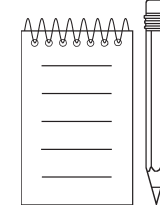
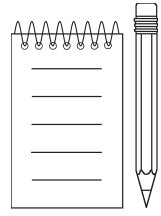

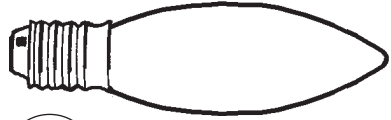

5

You will need 3 - B10
25 Watts Recommended
40 Watts Max
MIN 75°C SUPPLY
CONDUCTORS

Install bulbs and be sure
to test fixture **BEFORE**
trimming.

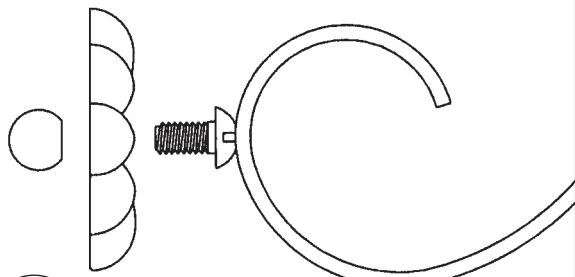

6

Slide rosettes with flat side
facing towards you onto
the screws and secure with
balls provided.

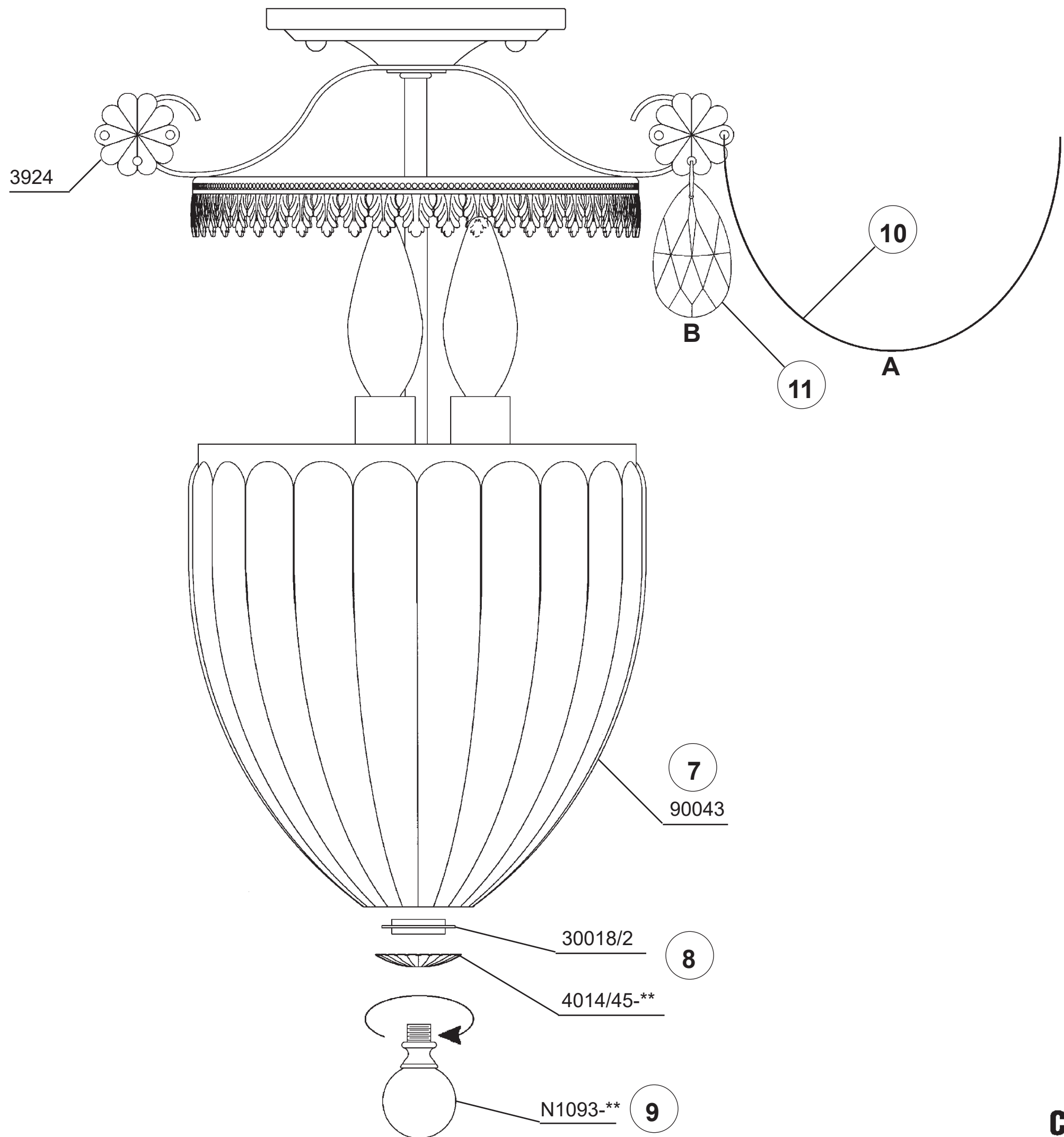

 **SCHONBEK** | 1870











BAGATELLE 1242- _____



THIS DESIGN IS THE PROPRIETARY TRADE DRESS/TRADEMARK OF W SCHONBEK LLC.

3 Lights
Diameter: 10-1/2"
Body Length: 12"
Hanging Weight: 8 lbs.

 **SCHONBEK** | 1870

								
MAX 40 W		110-120 V						

All electrical components must be installed by a licensed electrician in accordance with the National Electric Code and the appropriate local electrical codes.

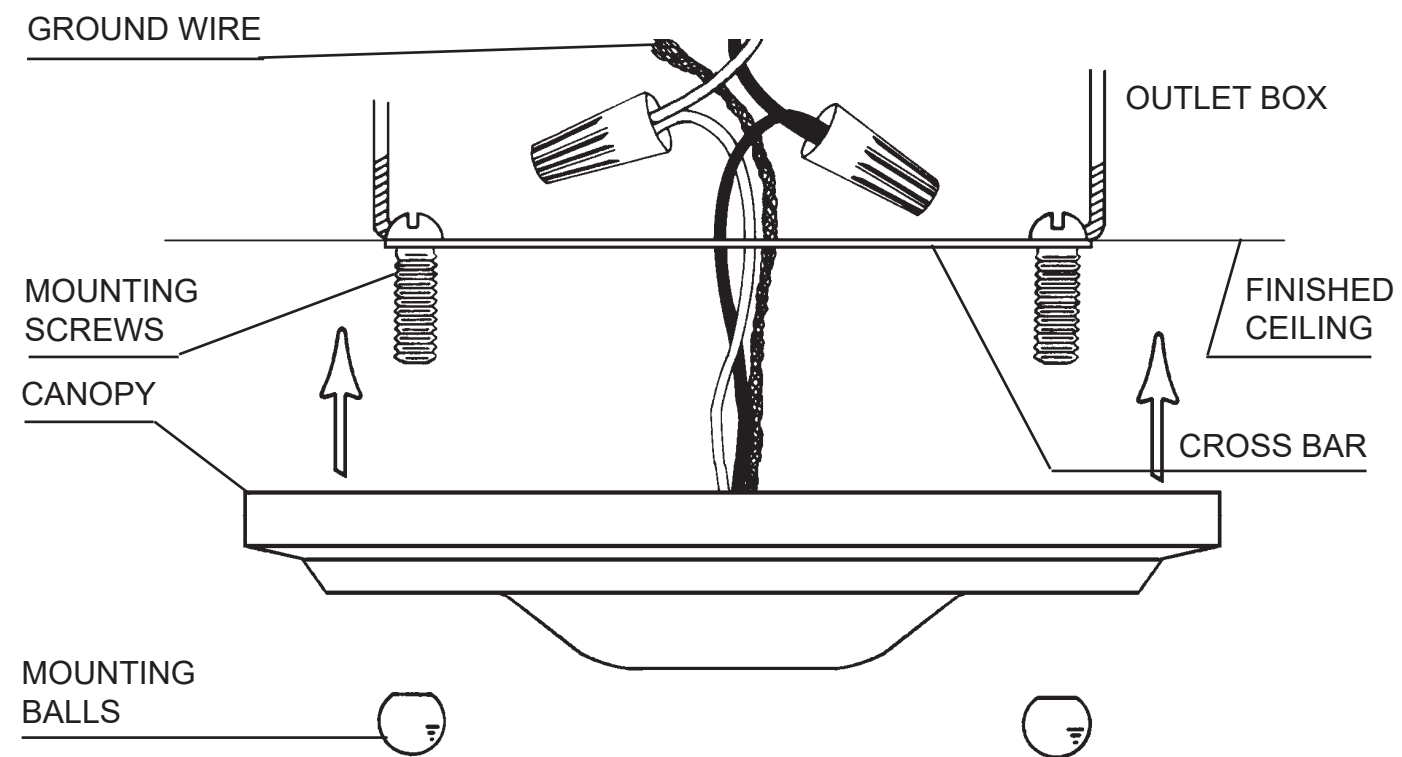

- 1** Attach cross bar to outlet box.
- 2** Again, make sure that power to the outlet box is disconnected. Feed stem wires through cross bar and attach to power wires in outlet box. Fixture **MUST** be properly grounded.
- 3** Attach canopy to ceiling with mounting balls, thereby retaining complete fixture against ceiling.
- 4** Screw bulb into socket. Test power to insure proper wiring before hanging trim from fixture.

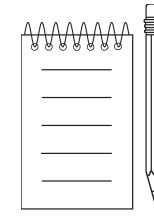



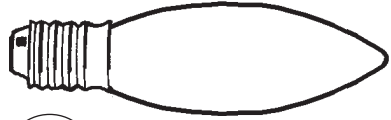

5

You will need 3 - B10
25 Watts Recommended
40 Watts Max
MIN 75°C SUPPLY
CONDUCTORS

Install bulbs and be sure
to test fixture **BEFORE**
trimming.

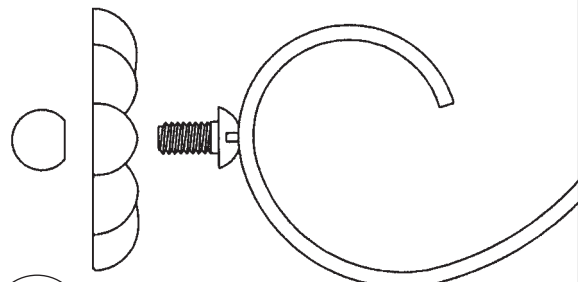

6

Slide rosettes with flat side
facing towards you onto
the screws and secure with
balls provided.

