

ARLINGTON 1301H













2 Lights
Diameter: 14-1/2"
Body Length: 16"
Extension: 6"
Hanging Weight: 5 lbs.

THIS DESIGN IS THE PROPRIETARY
TRADE DRESS/TRADEMARK OF
W SCHONBEK LLC.

 **SCHONBEK** | 1870

 **SCHONBEK** | 1870

								
MAX 60 W	110-120 V							

All electrical components must be installed by a licensed electrician in accordance with the National Electric Code and the appropriate local electrical codes.

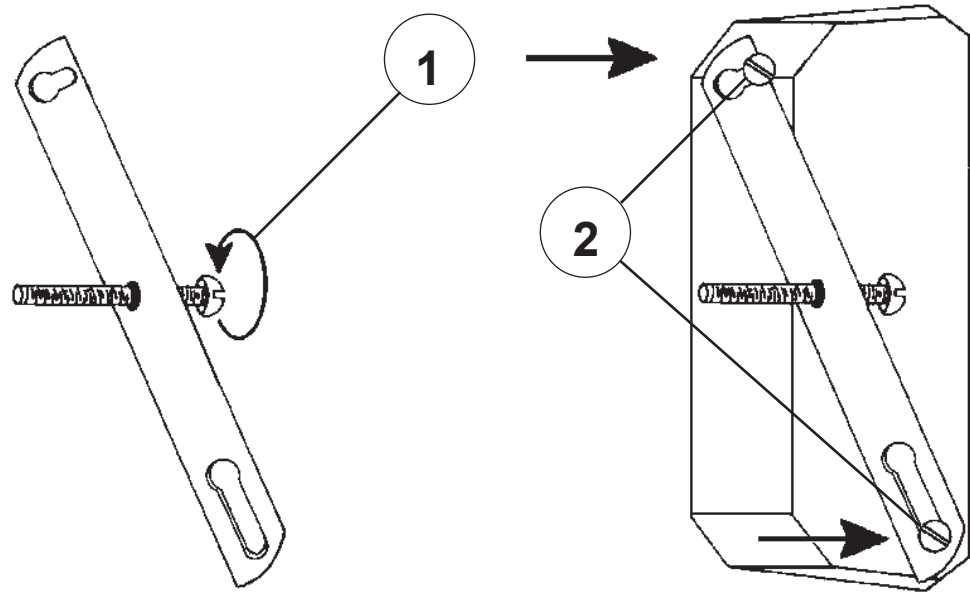

Turn arms to line up holes in arms with dimple in plate. Tighten lock washer and nut to secure arms in place.

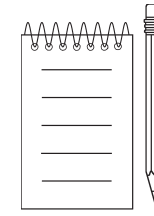
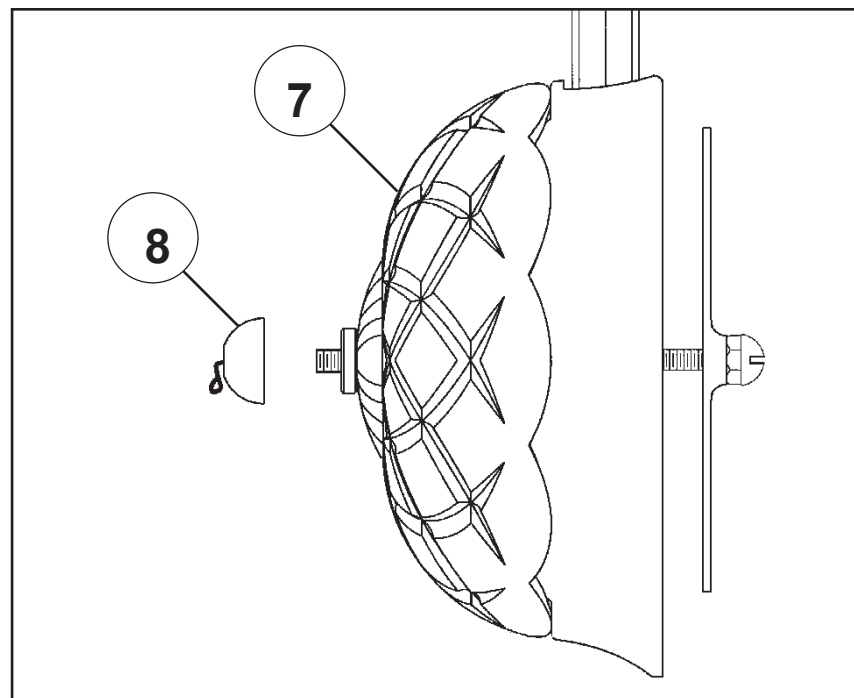
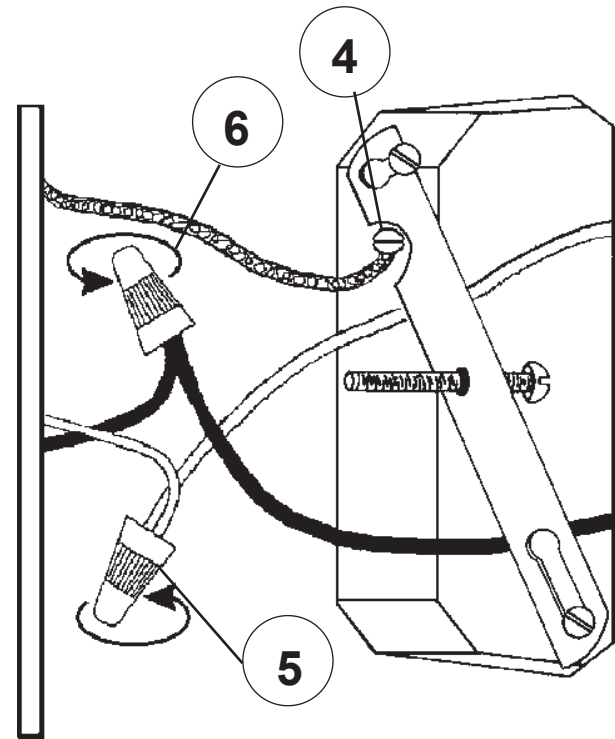
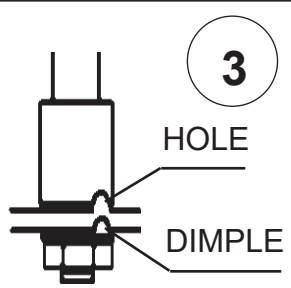





9

You will need 2 - B10
25 Watts Recommended
60 Watts Max

Install bulbs and be sure
to test fixture **BEFORE**
trimming.

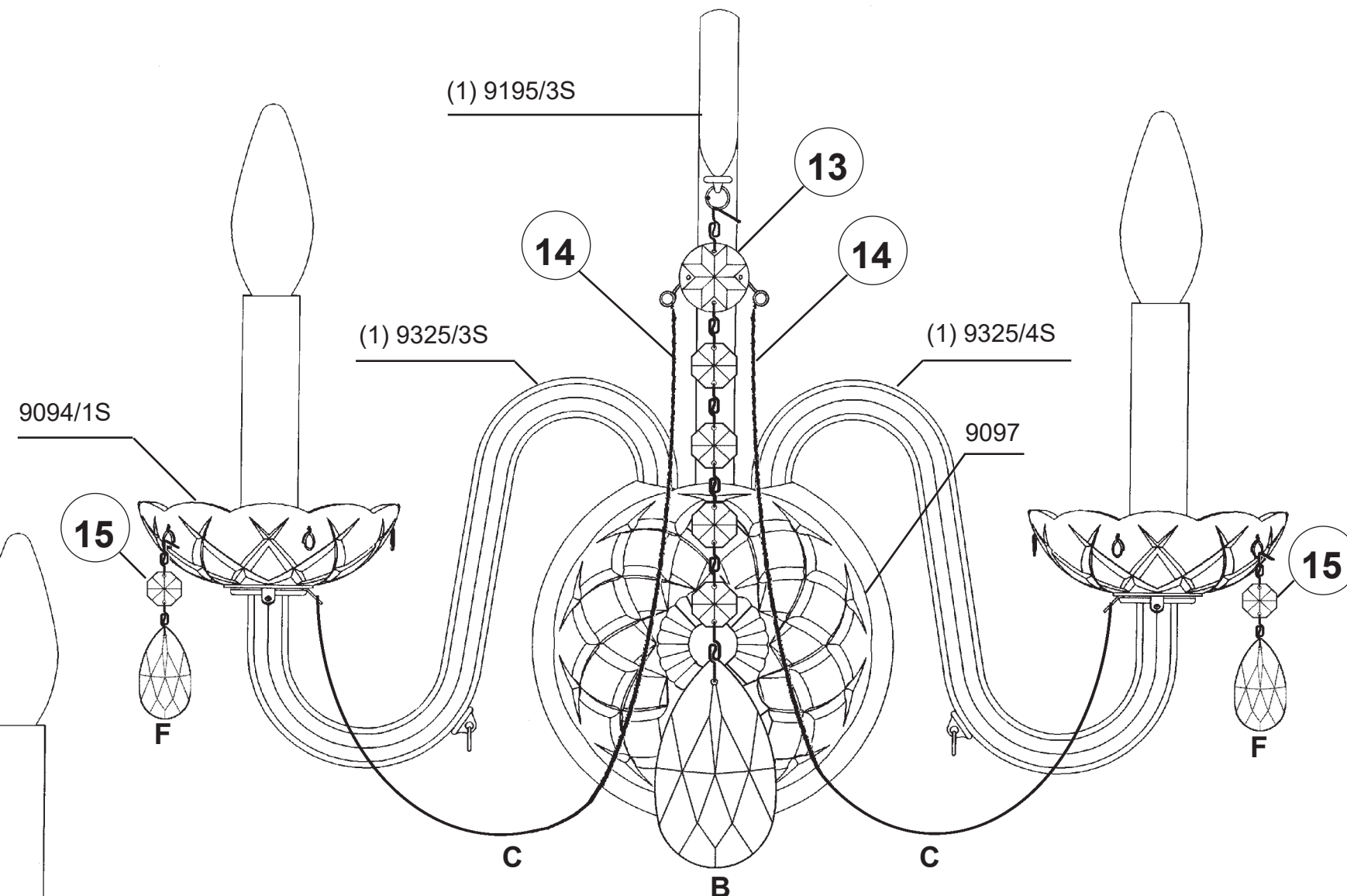
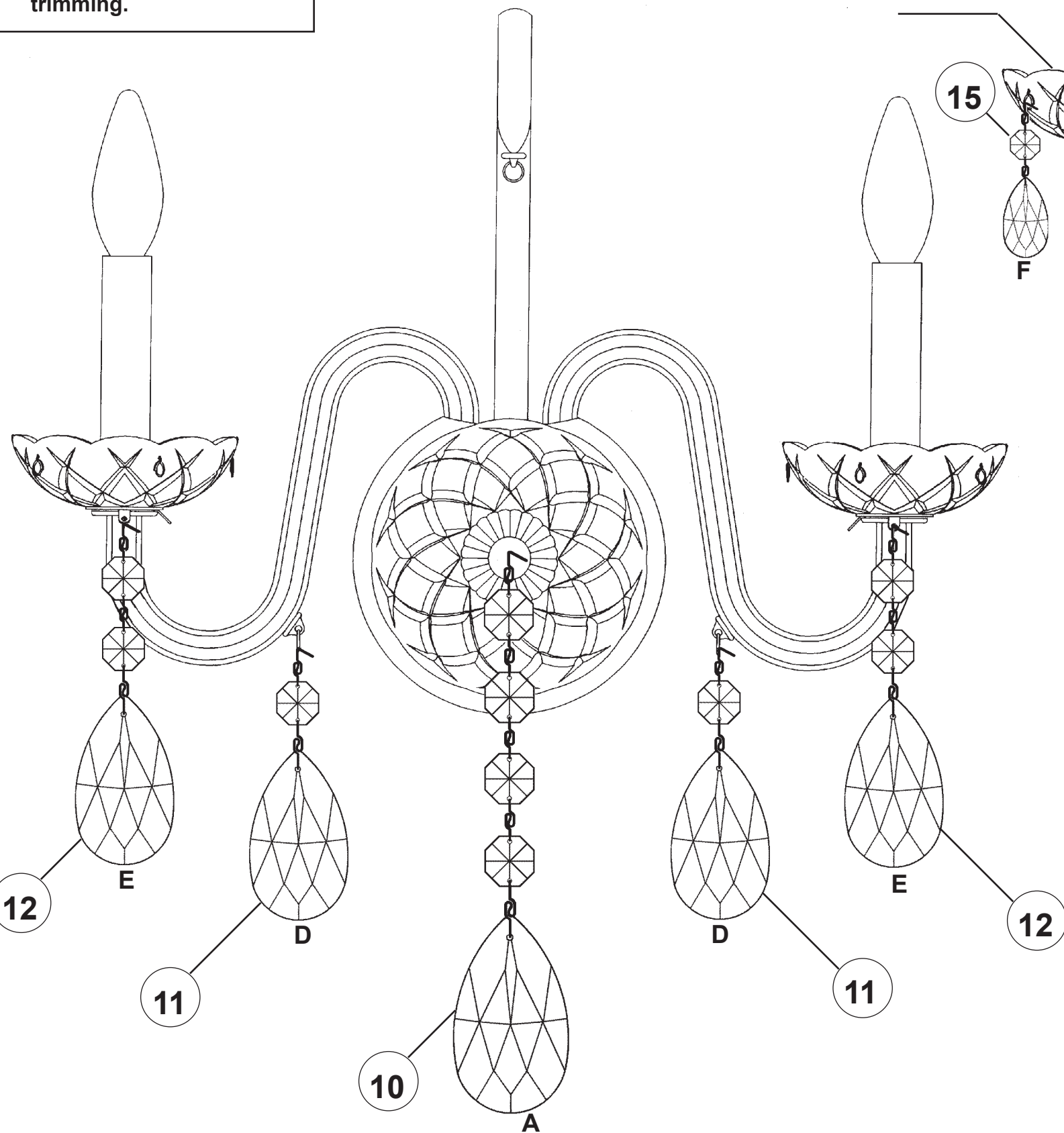

CAUTION: Glass parts are fragile.
To avoid breakage use care when
assembling or cleaning.

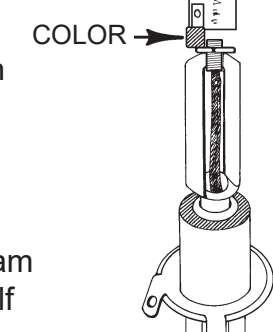

**WHEN ORDERING REPLACEMENT
ARM(S):**

- Give arm number from trim diagram
- Give color code from the arm itself

