

 **SCHONBEK** | 1870

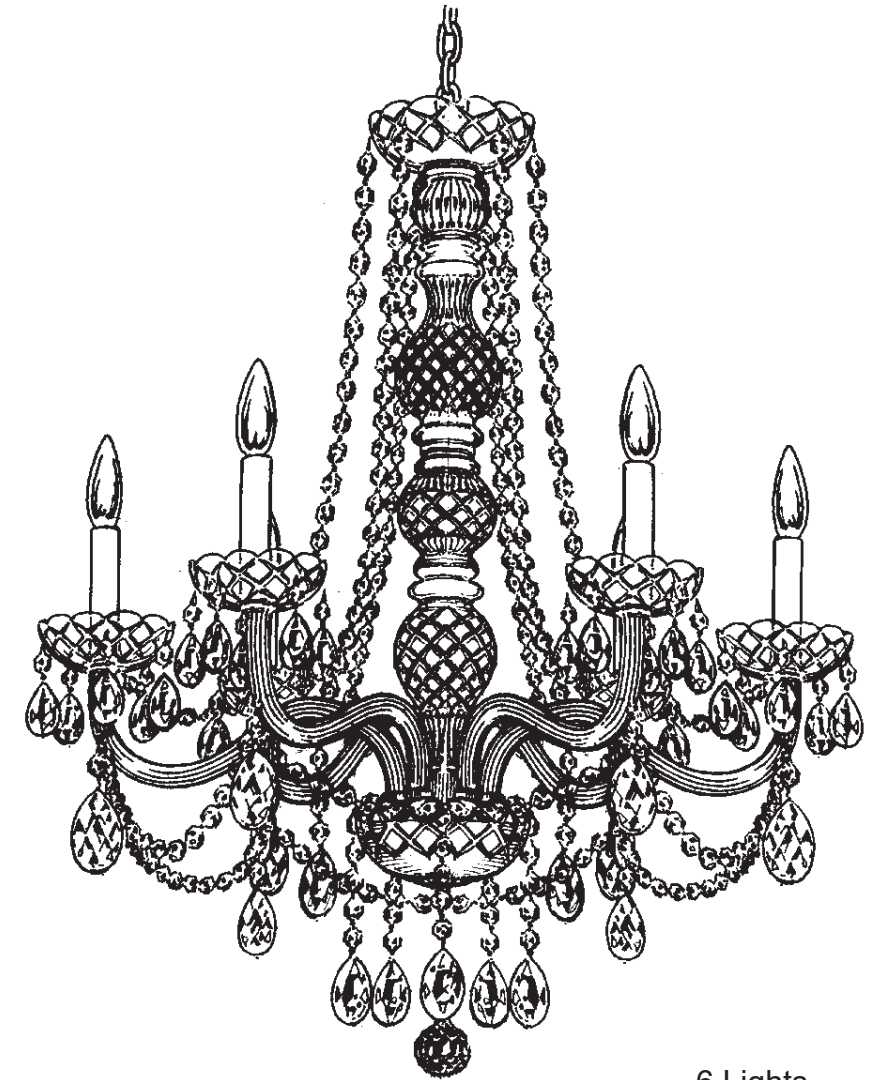









ARLINGTON 1303H



THIS DESIGN IS THE PROPRIETARY
TRADE DRESS/TRADEMARK OF
W SCHONBEK LLC.

6 Lights
Diameter: 24"
Body Length: 28"
Hanging Weight: 12 lbs.

 **SCHONBEK** | 1870

								
MAX 60 W	110-120 V							

All electrical components must be installed by a licensed electrician in accordance with the National Electric Code and the appropriate local electrical codes.

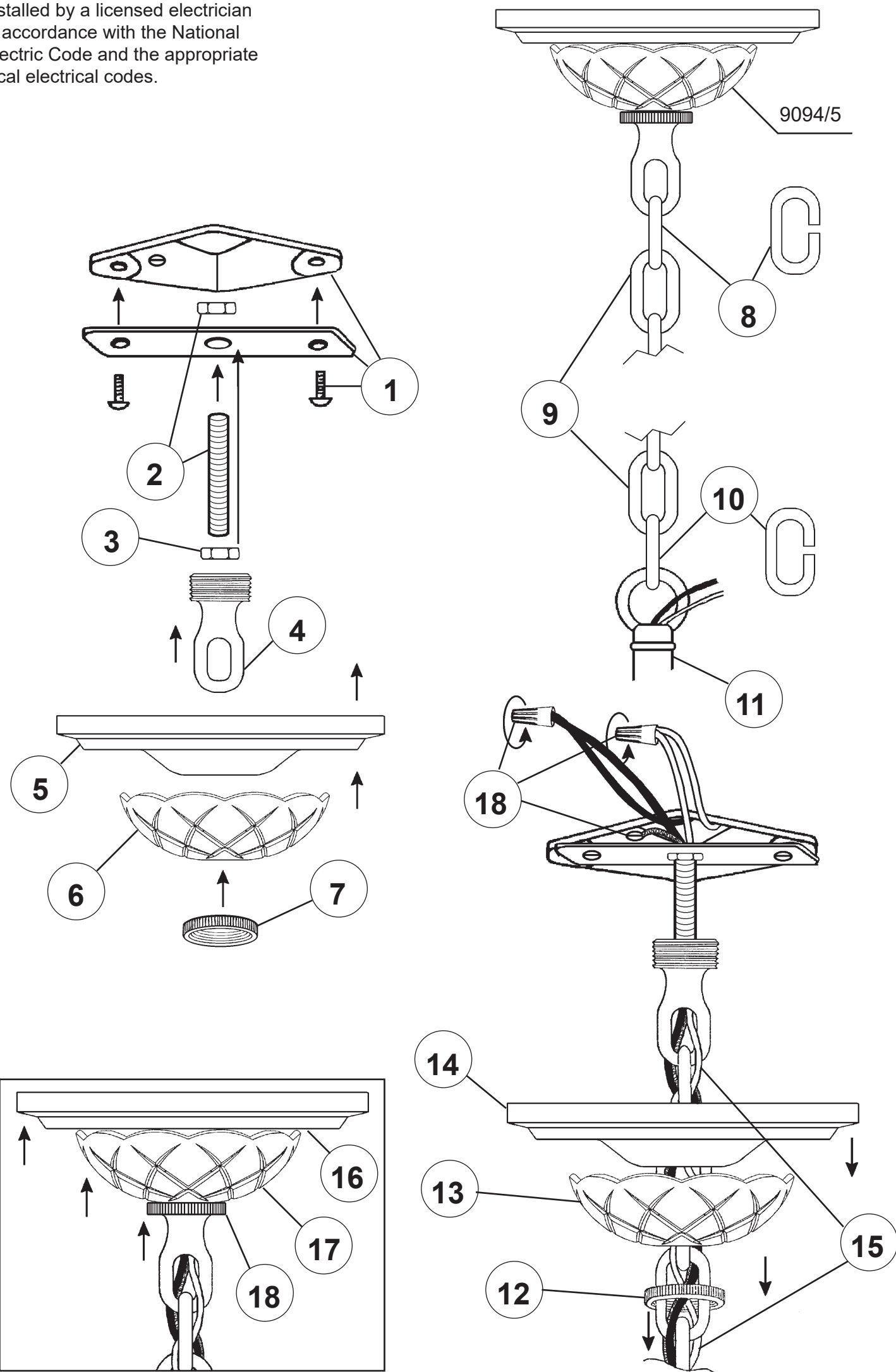

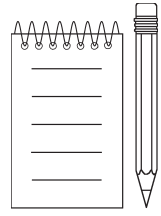



20

You will need 6 - B10
25 Watts Recommended
60 Watts Max

**Install bulbs and be sure
to test fixture BEFORE
trimming.**

19 Install arms into washer. Line up holes in arms with dimple in washer. Use nut to secure arms in place.



**This end goes up
against washer.**

Connect ground wire in each arm (silver wire) to ground wire in center column. **NO MORE THAN 5-WIRES PER WIRE NUT.** Use electrical tape to secure wire nuts.

Connect white arm wires to neutral column wire (ribbed or marked is neutral).

Connect black arm wires to the power wire in column.

Carefully press wires as close as possible to the underside of washer.

Attach metal enclosure with nut provided. Slide spacer and glass dish up over stem pipe and attach with rosette, round nut and half ball.

Install bobèche.

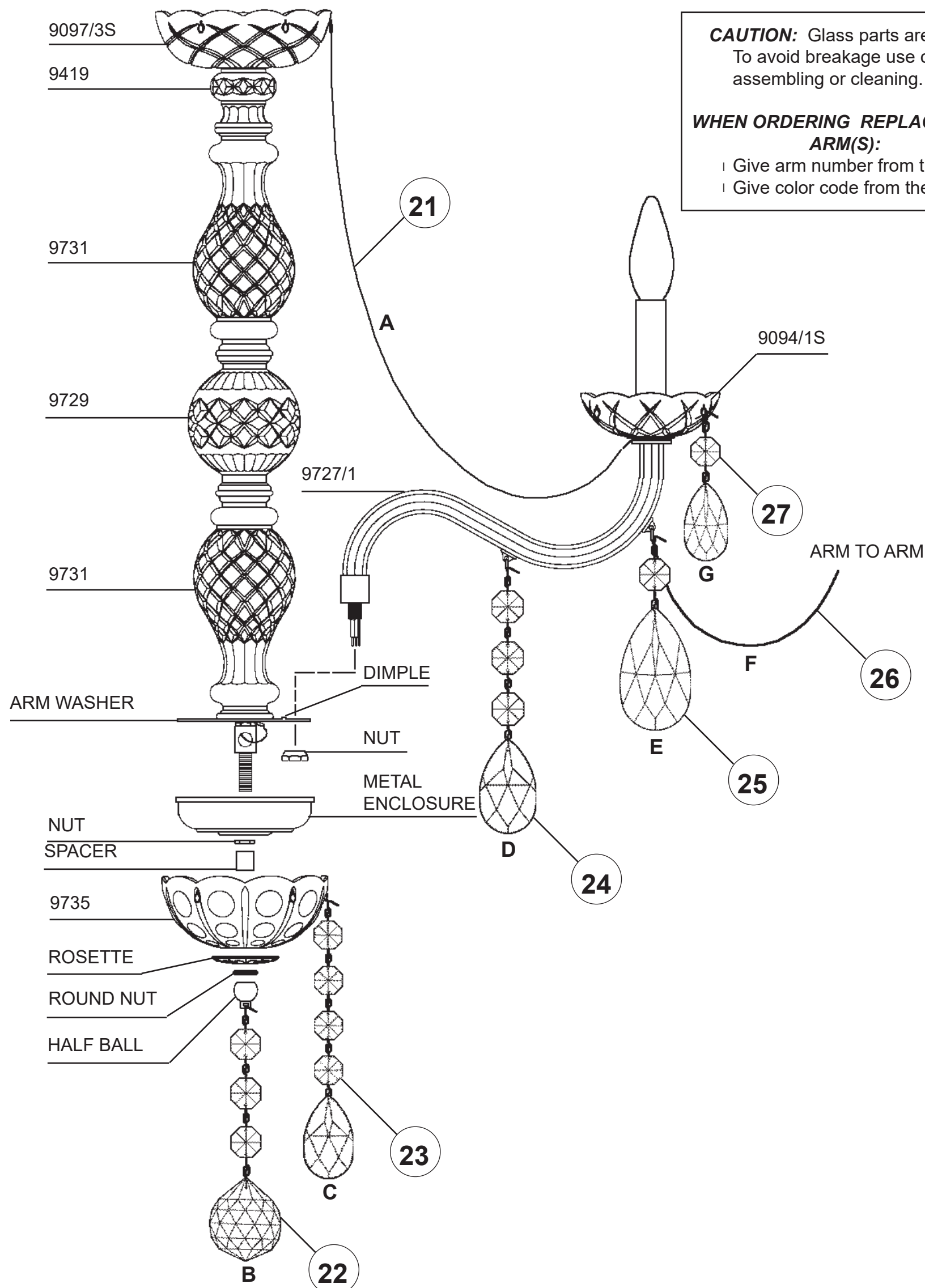

CAUTION: Glass parts are fragile.
To avoid breakage use care when
assembling or cleaning.

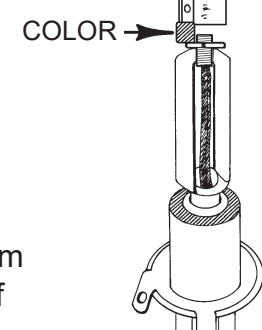

**WHEN ORDERING REPLACEMENT
ARM(S):**

- ┆ Give arm number from trim diagram
- ┆ Give color code from the arm itself

