

CHANDELIER 1310H TRIM DIAGRAM

Instructions for electrician

STEPS 2 - 21

WARNING: THIS LUMINAIRE MUST BE MOUNTED OR SUPPORTED INDEPENDENTLY OF AN OUTLET BOX.

WARNING:

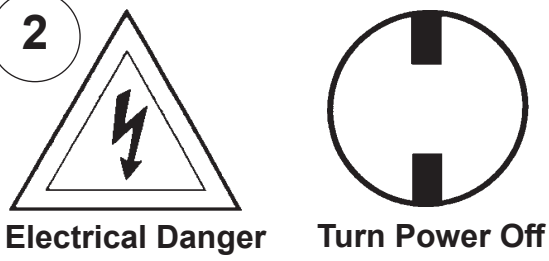

All electrical components must be installed by a licensed electrician in accordance with the National Electric Code and the appropriate local electrical codes.

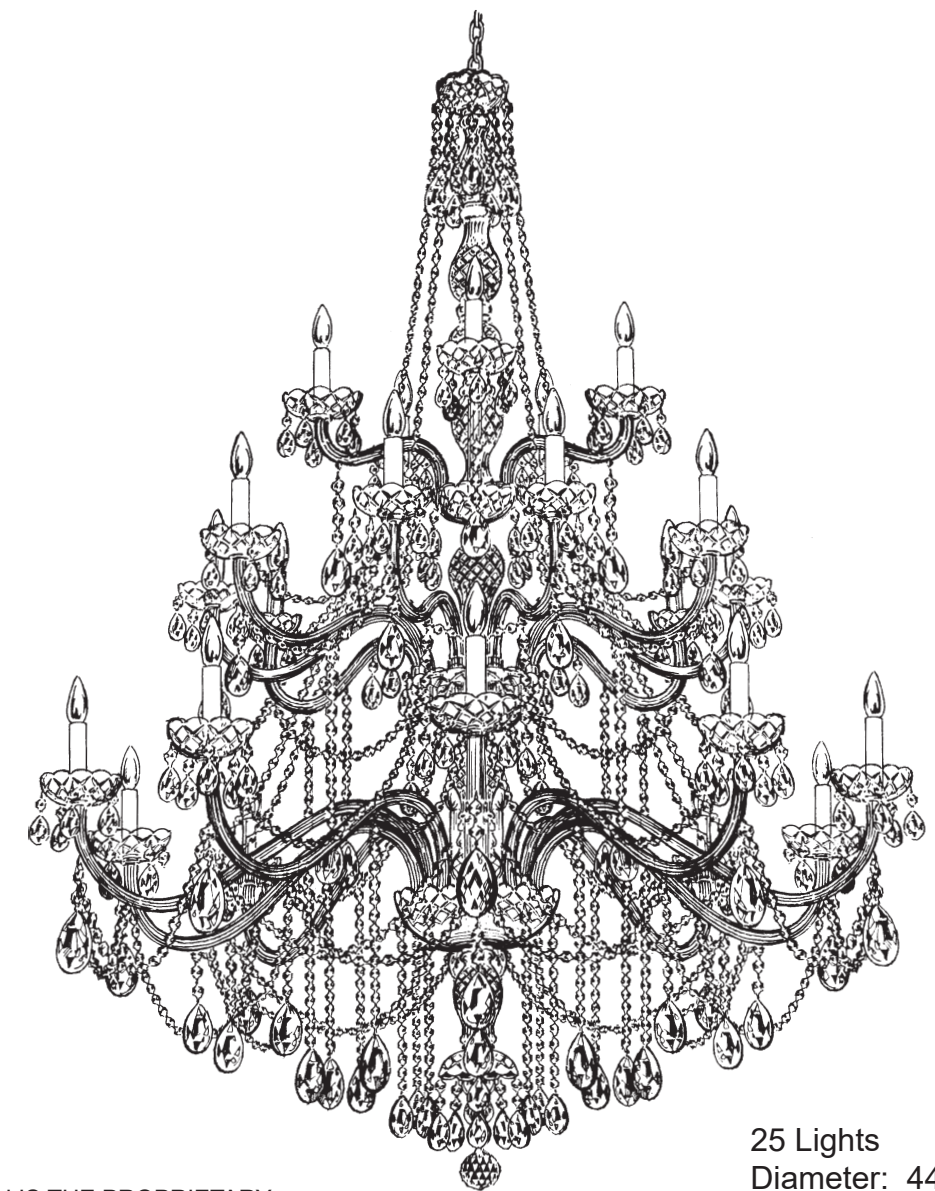
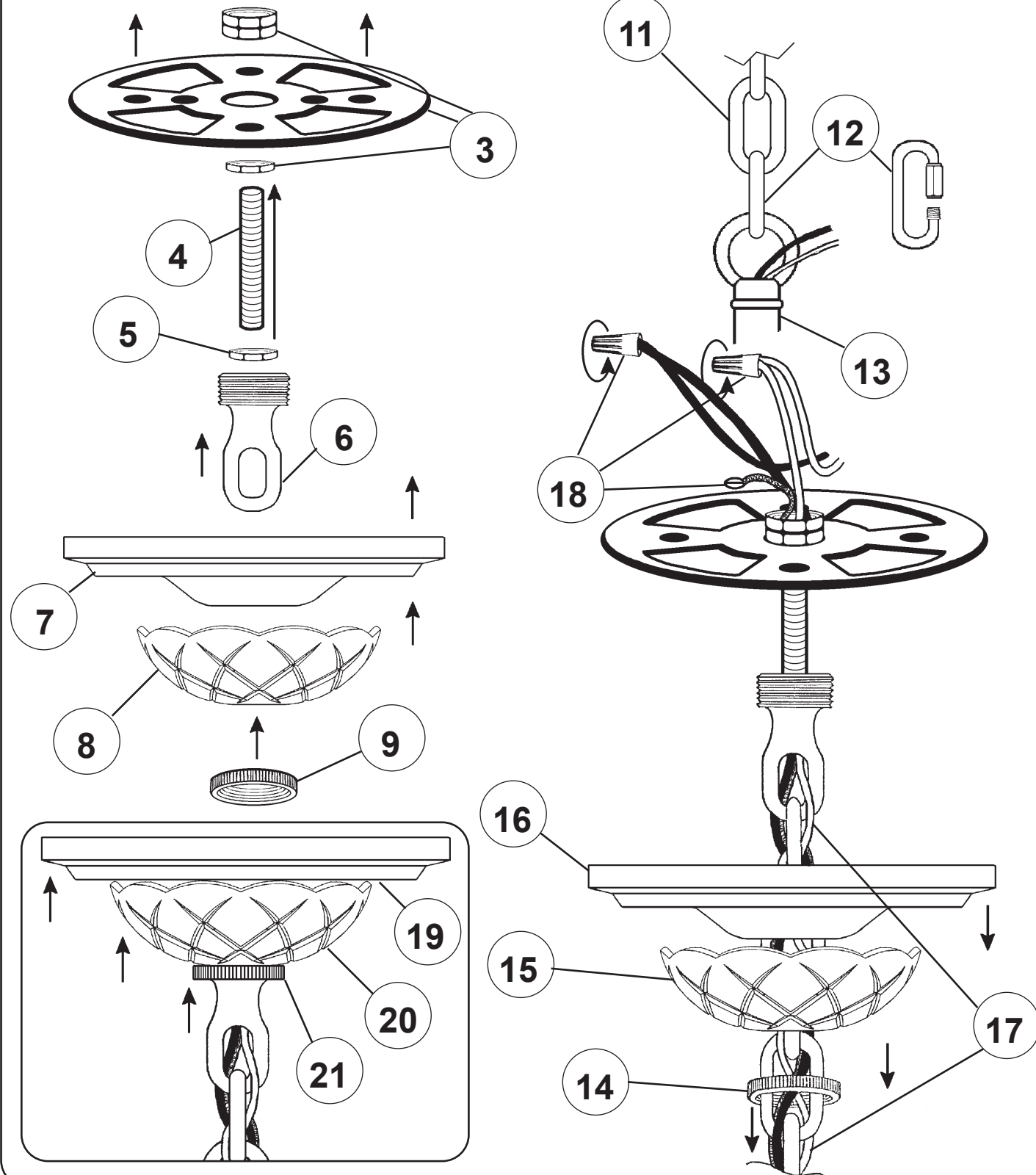

25 Lights
 Diameter: 44-1/2"
 Body Length: 62"
 Hanging Weight: 55 pounds

THIS DESIGN IS THE PROPRIETARY TRADE DRESS/TRADEMARK OF W SCHONBEK LLC.



See diagram on back page
 Follow steps in exact order
 Save this trim diagram for future reference

1 **IMPORTANT**
 Person who opens carton should record the following information for future service.
 CODE # _____ Four-digit number on outside of carton.
 PACKER # _____ See crystal package label.
 ORDER # _____ See crystal package label.



Instructions for crystal trimming

STEPS 22 - 41

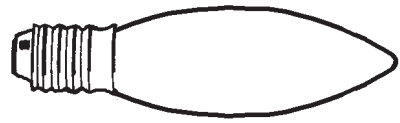

23

You will need 25 - B10
25 Watts Recommended
60 Watts Max

Install bulbs and be sure
to test fixture **BEFORE**
trimming.

22 Connect upper arm wires to the
center column using plug-in connectors.
See detailed illustration.

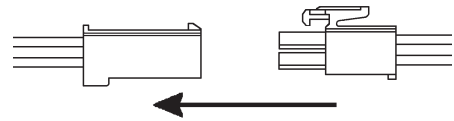

Push wires into hole and attach arm to
upper washer by rotating arm into place.
Lock down by tightening screws into flange.
See detailed illustration.

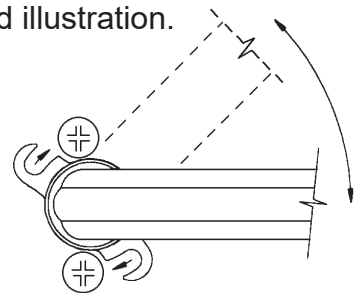

Repeat steps for middle and lower arms.
Install bobèche.

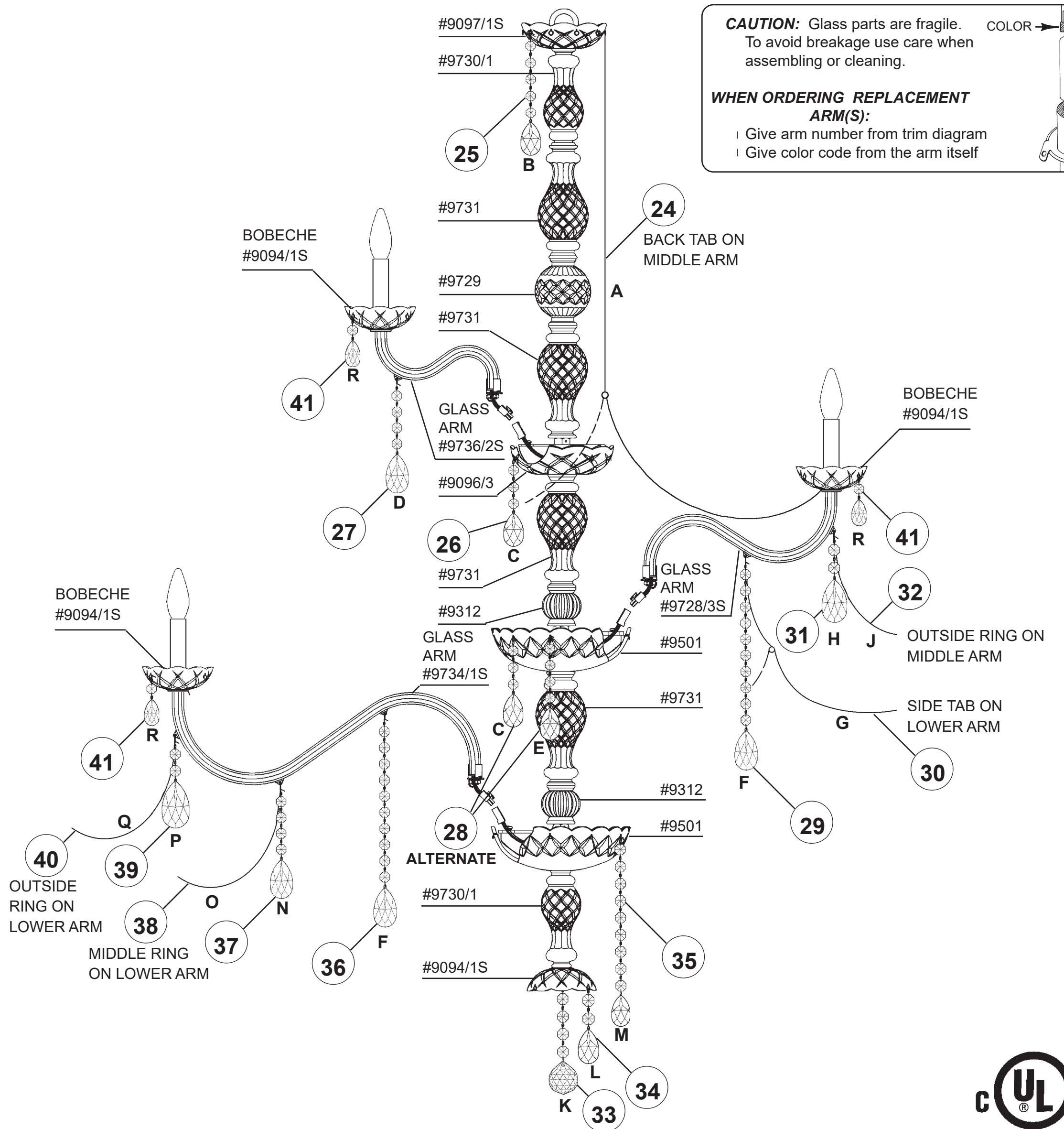

CAUTION: Glass parts are fragile.
To avoid breakage use care when
assembling or cleaning.

**WHEN ORDERING REPLACEMENT
ARM(S):**

- Give arm number from trim diagram
- Give color code from the arm itself

COLOR →

