

CENTURY 1705- \_ \_ \_

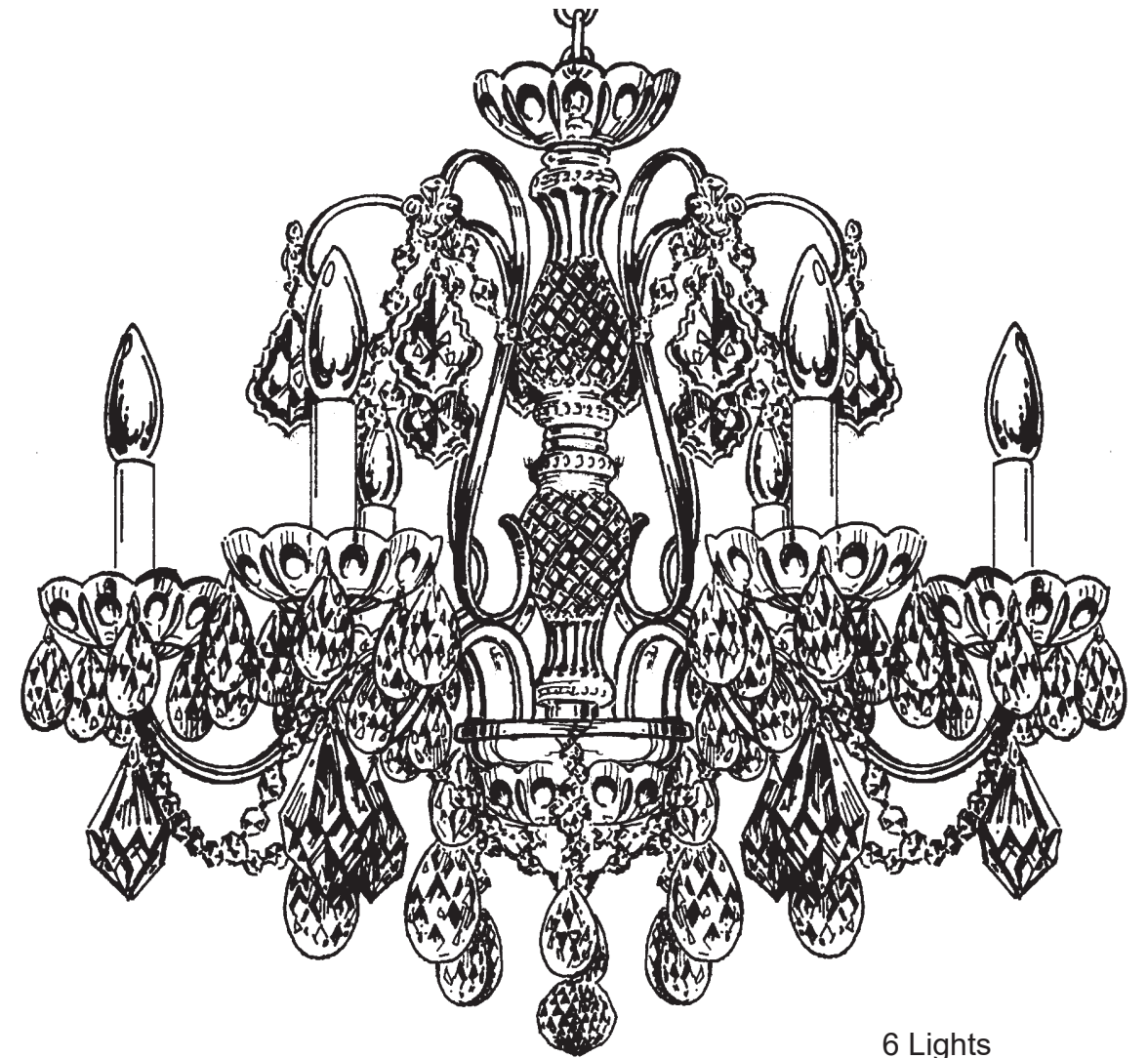











6 Lights  
Diameter: 21"  
Body Length: 20"  
Hanging Weight: 14 lbs.

**T**HIS DESIGN IS THE PROPRIETARY  
TRADE DRESS/TRADEMARK OF  
W SCHONBEK LLC.

 **SCHONBEK** | 1870

 **SCHONBEK** | 1870

								
MAX 60 W		110-120 V						

All electrical components must be installed by a licensed electrician in accordance with the National Electric Code and the appropriate local electrical codes.

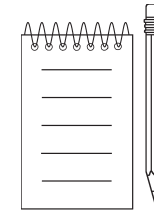
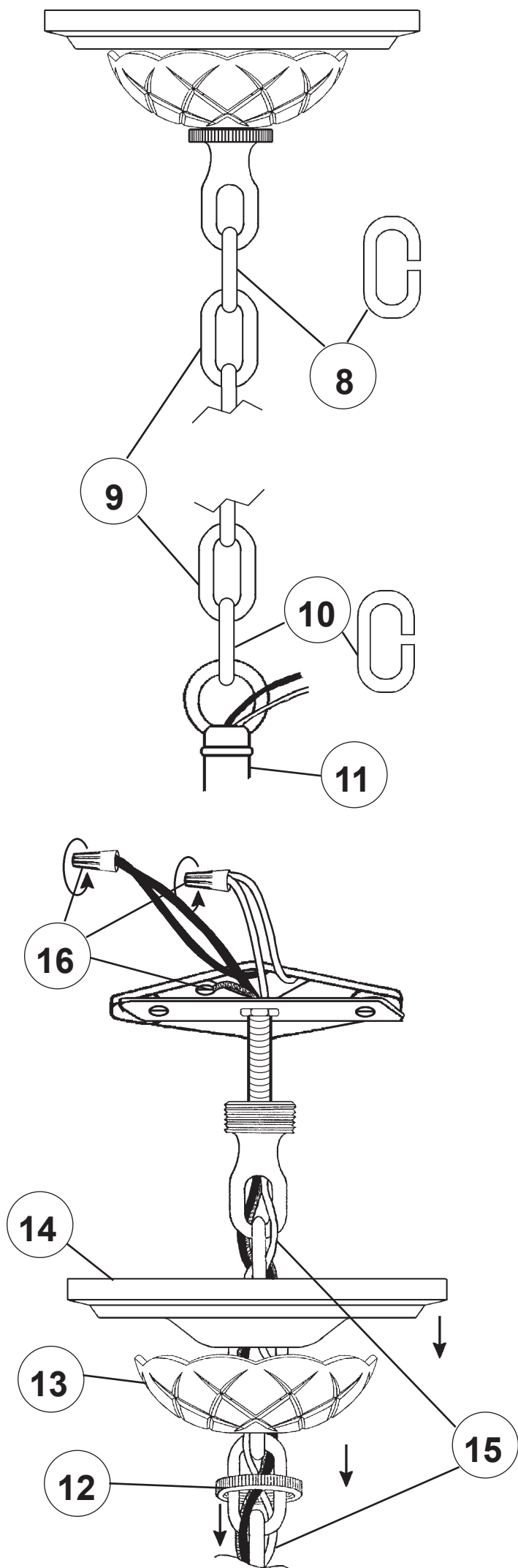
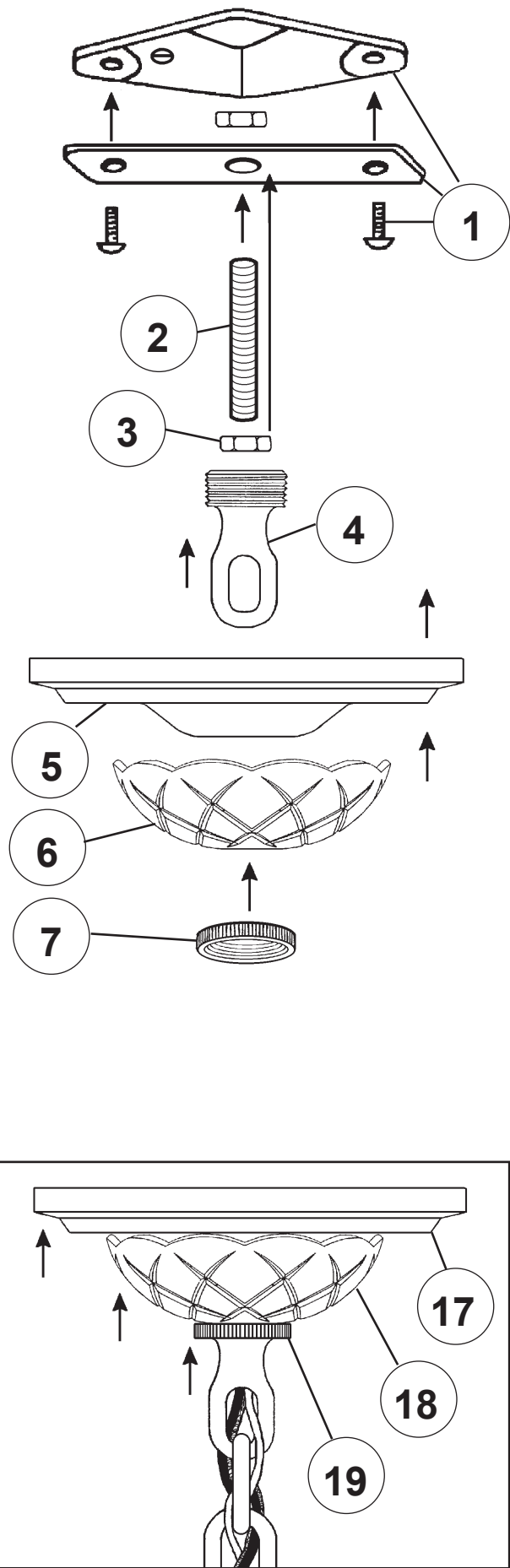

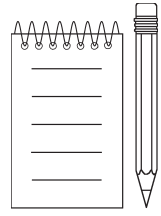

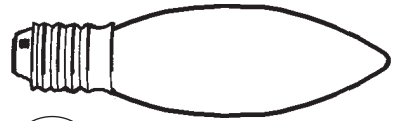

20

You will need 6 - B10  
25 Watts Recommended  
60 Watts Max

Install bulb and be sure  
to test fixture **BEFORE**  
trimming.

