

CENTURY 1707- \_ \_ \_

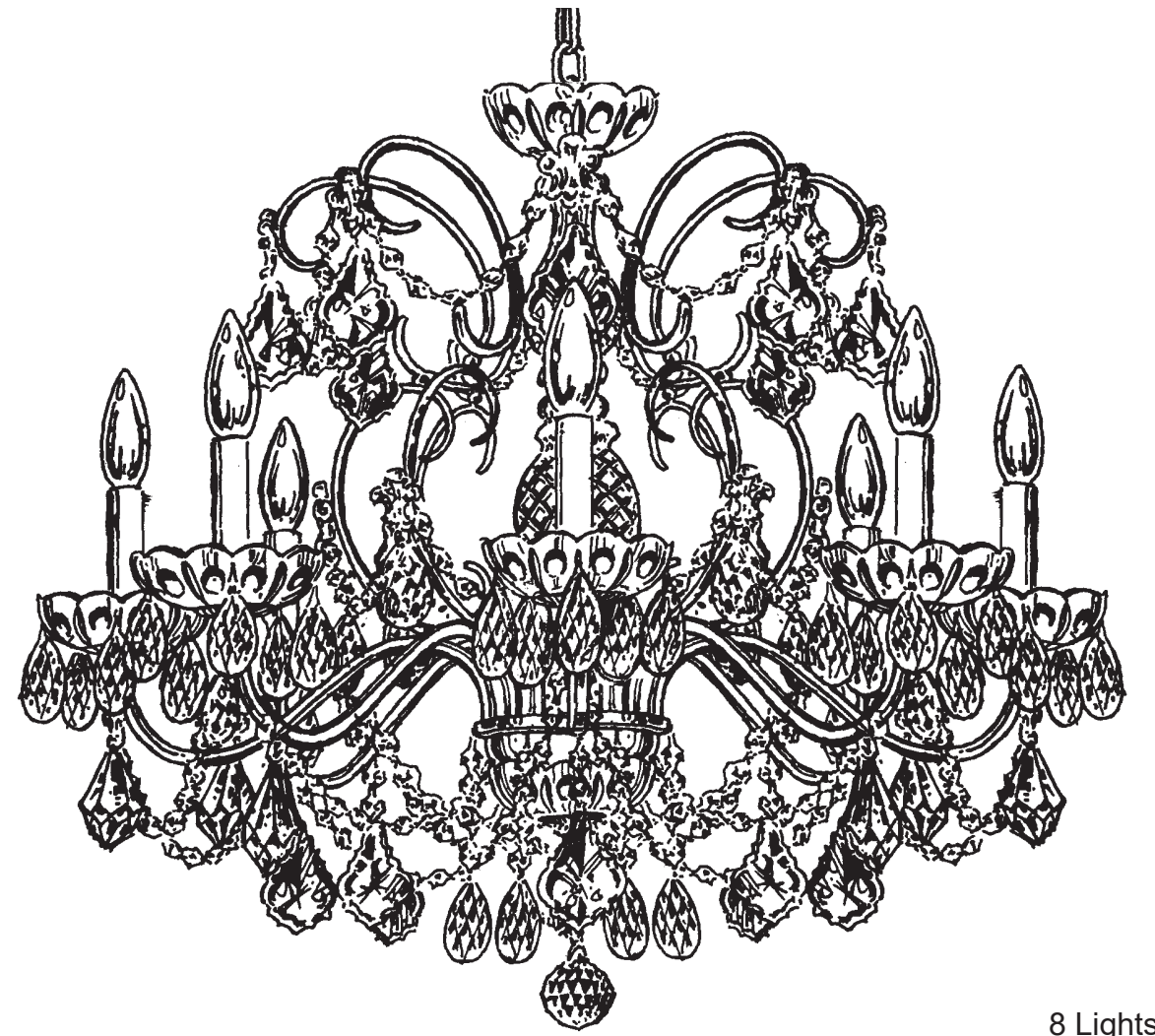











8 Lights  
Diameter: 24"  
Body Length: 21-1/2"  
Hanging Weight: 17 lbs.

**T**HIS DESIGN IS THE PROPRIETARY  
TRADE DRESS/TRADEMARK OF  
W SCHONBEK LLC.

 **SCHONBEK** | 1870

 **SCHONBEK** | 1870

								
MAX 60 W		110-120 V						

All electrical components must be installed by a licensed electrician in accordance with the National Electric Code and the appropriate local electrical codes.

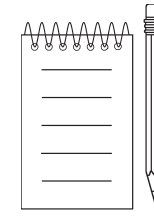
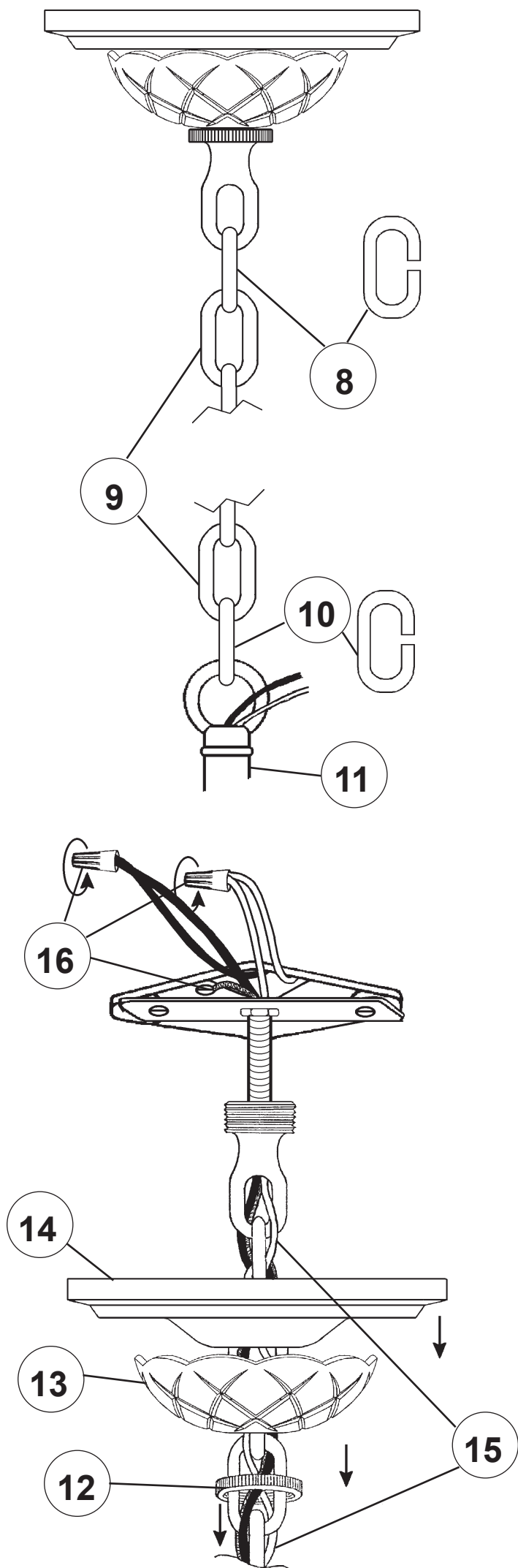
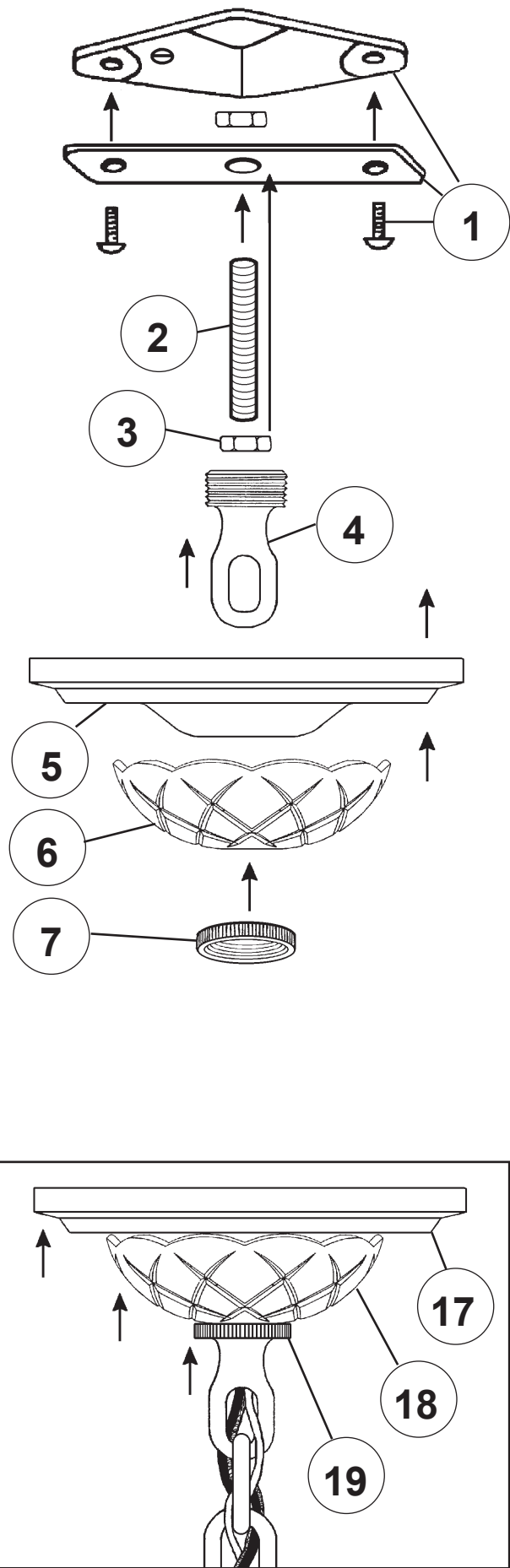



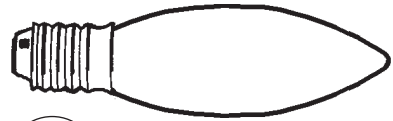

20

You will need 8 - B10  
25 Watts Recommended  
60 Watts Max

Install bulb and be sure  
to test fixture **BEFORE**  
trimming.

