

QUANTUM 22360 TRIM DIAGRAM

Instructions for electrician STEP 2 - 5

WARNING:

2

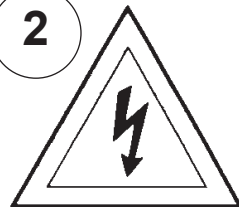

Electrical Danger

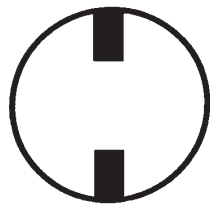

All electrical components must be installed by a licensed electrician in accordance with the National Electric Code and the appropriate local electrical codes.

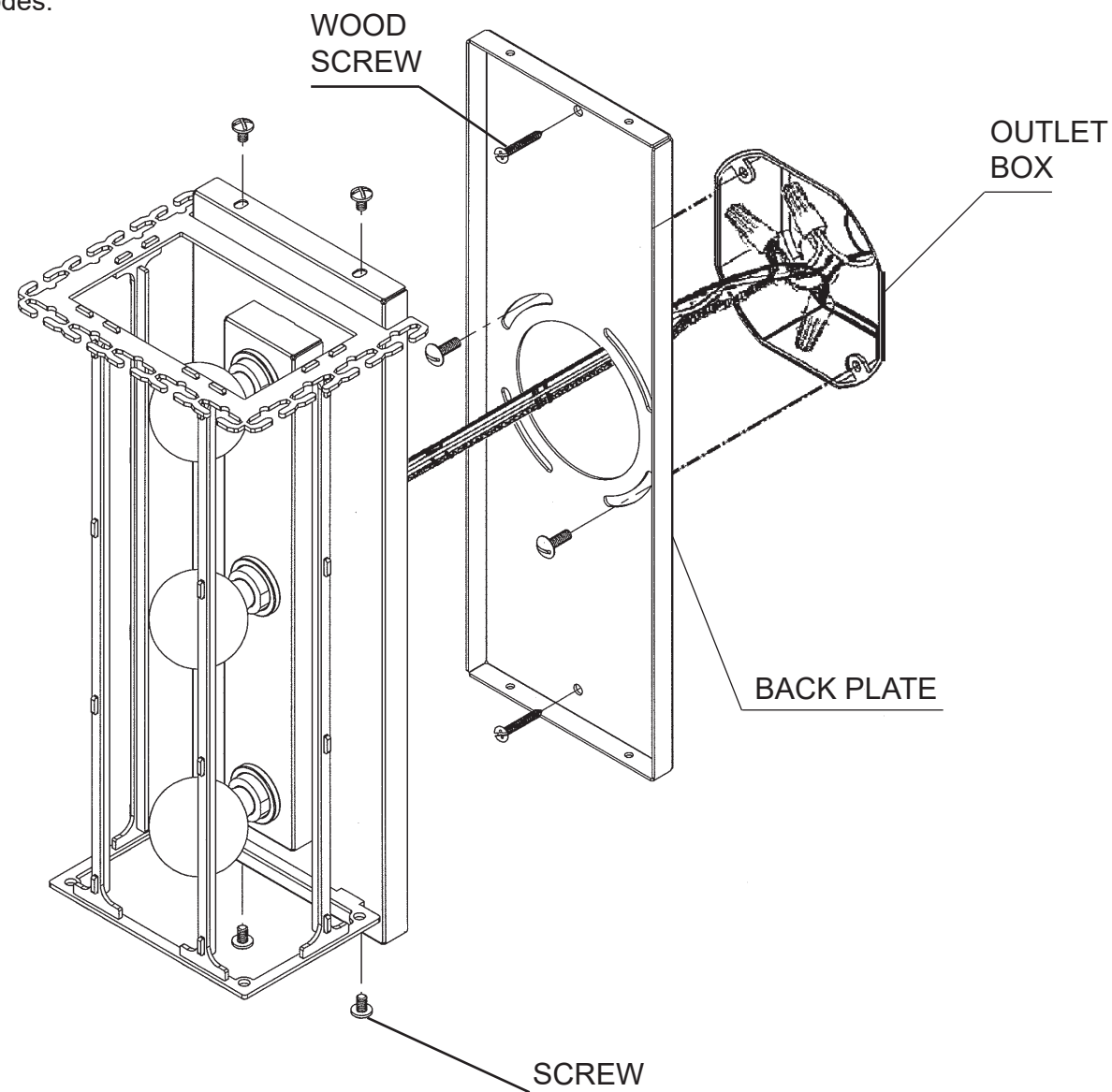

3 Remove the (4) wall sconce screws and separate the back plate from the wall sconce. Feed stem and ground wires through back plate, then attach to power wires and ground wire in outlet box.

4 Attach back plate to the outlet box with (2) screws. Supplied are (2) wood screws to stop the wall sconce from pivoting.

5 Attach wall sconce to back plate and tighten the four screws removed previously.

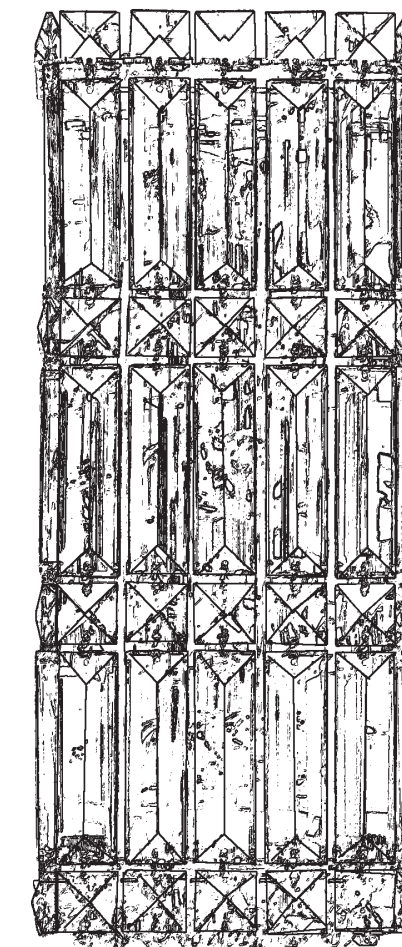

3 Lights
Length: 5-1/2"
Extension: 4-1/2"
Height: 13"
Weight: 6 lbs.

THIS DESIGN IS THE PROPRIETARY TRADE DRESS/TRADEMARK OF W SCHONBEK LLC.



SCHONBEK | 1870

**See diagram on back page
Follow steps in exact order
Save this trim diagram for future reference**

1

IMPORTANT

Person who opens carton should record the following information for future service.

CODE # _____ Four-digit number on outside of carton.
PACKER # _____ See crystal package label.
ORDER # _____ See crystal package label.



Instructions for crystal trimming

STEPS 6 - 8

6

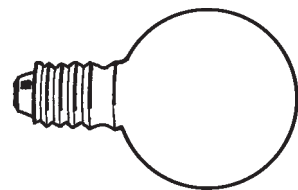

You will need 3 - G11
40 Watts Max
25 Watts recommended
(Supplied - Part #: 30205)

Install bulbs and be sure to test
fixture **BEFORE** trimming.



TOP PLATE

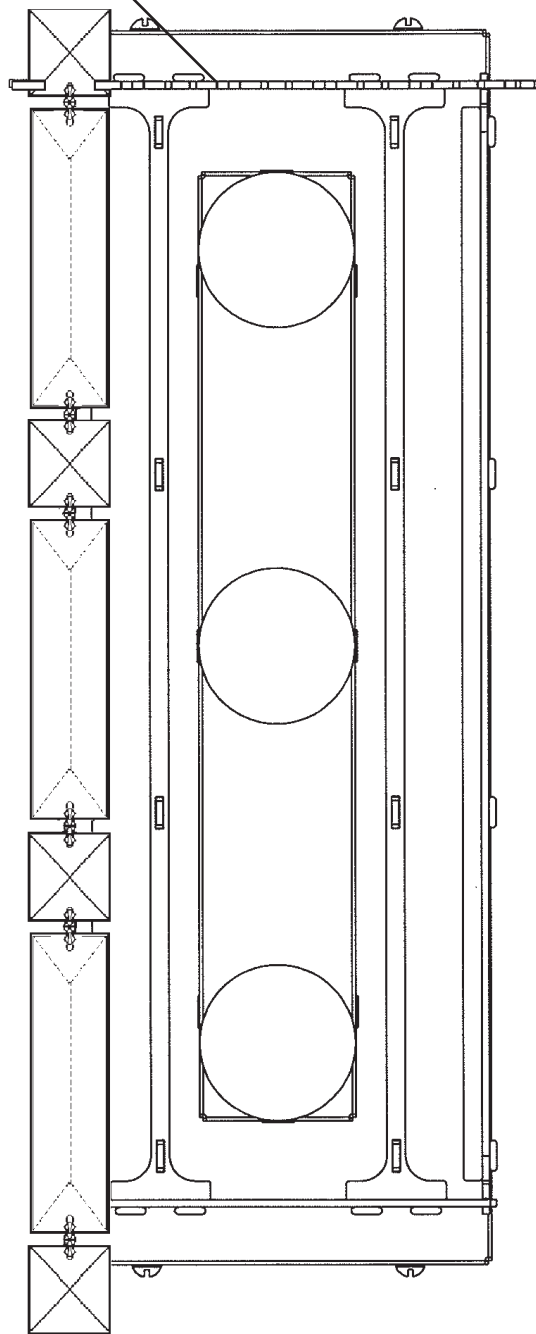

C

THUMB NUT

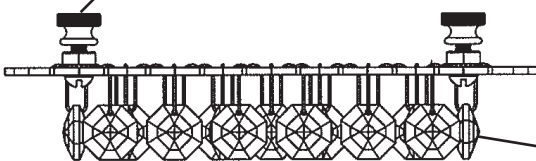

7 Install bottom crystal grid with four thumb nuts (already screwed onto grid) to bottom of the wall sconce.

8 Hold chain "C" by the top square crystal. (NOTE: Flat side of large crystals face out and chains are also symmetrical so either end will work!) Insert bottom square crystal into the pocket of bottom crystal grid. Then position the top connector (between the top two crystals) into the top plate pocket opening directly above the bottom crystal grid pocket. (Diagram #1) Lower the chain until the top square stone seats itself into the top plate pocket. When the chain is installed correctly, it will be held in place by both top and bottom pockets.

DIAGRAM
#1

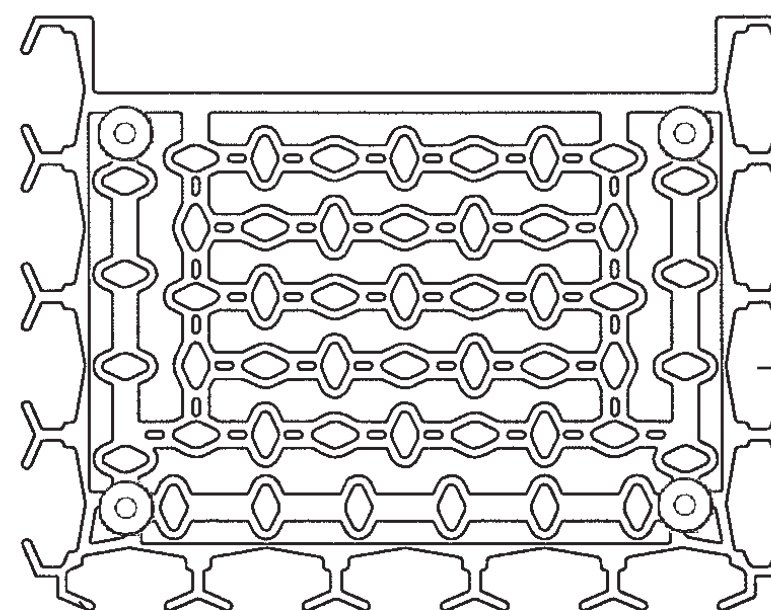
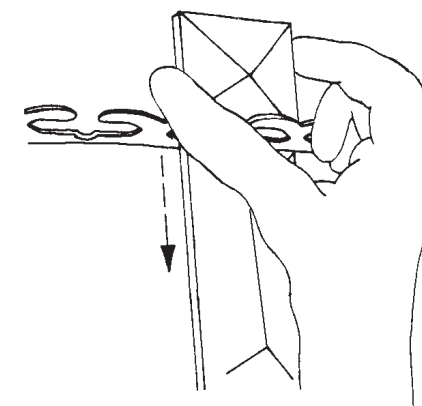

POCKET FOR "C"

BOTTOM
CRYSTAL GRID
#87/354/1SO

QUANTUM 2236R TRIM DIAGRAM

Instructions for electrician STEP 2 - 5

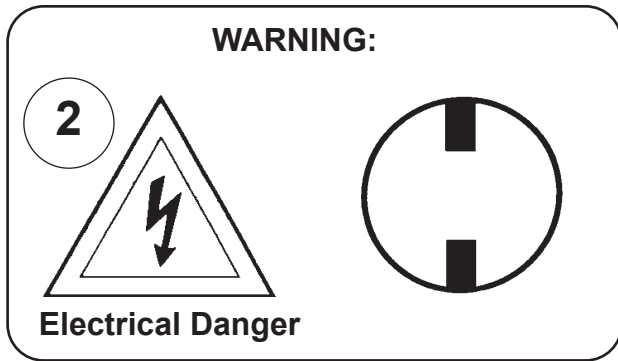

All electrical components must be installed by a licensed electrician in accordance with the National Electric Code and the appropriate local electrical codes.

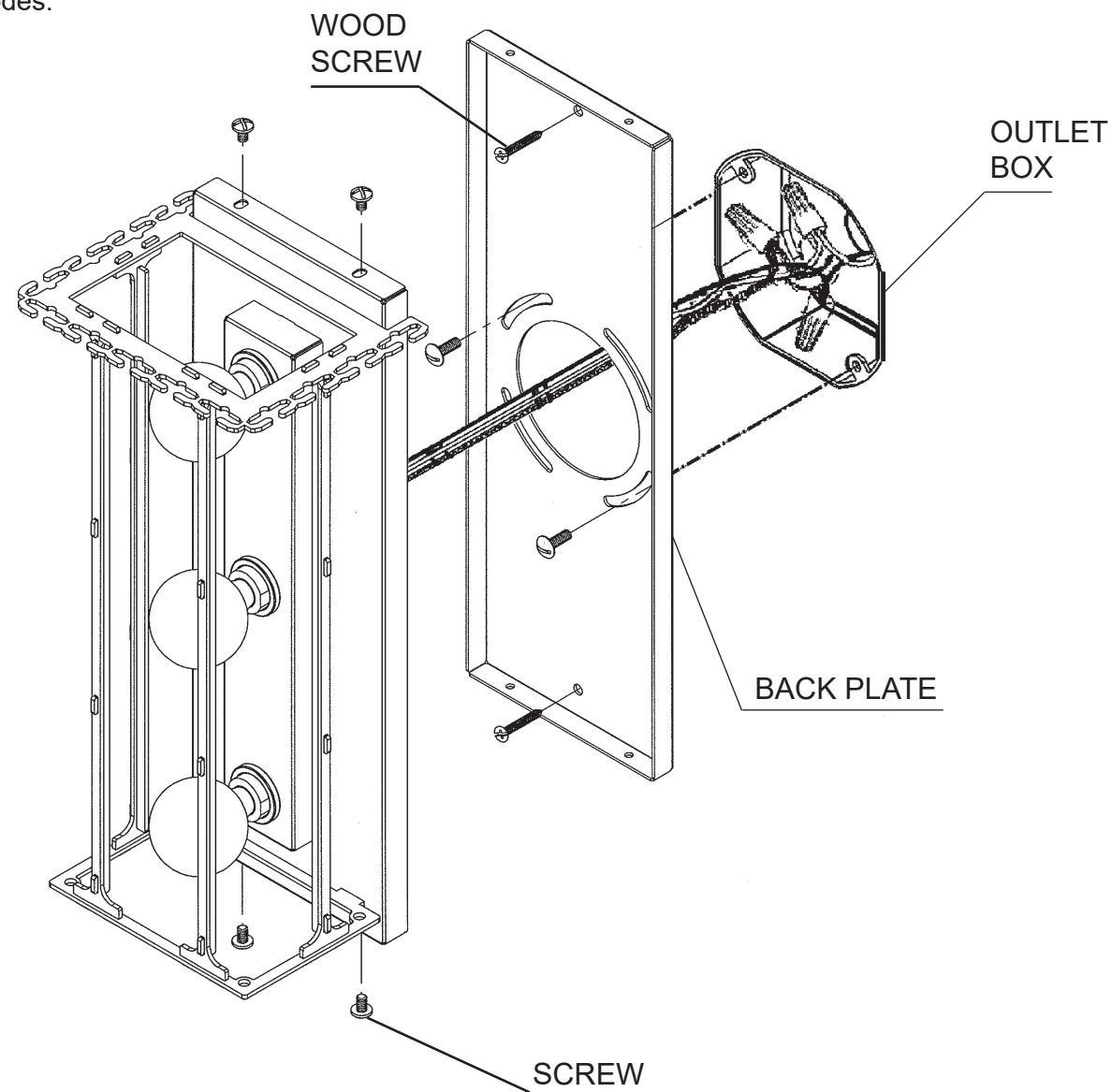

3 Remove the (4) wall sconce screws and separate the back plate from the wall sconce. Feed stem and ground wires through back plate, then attach to power wires and ground wire in outlet box.

4 Attach back plate to the outlet box with (2) screws. Supplied are (2) wood screws to stop the wall sconce from pivoting.

5 Attach wall sconce to back plate and tighten the four screws removed previously.

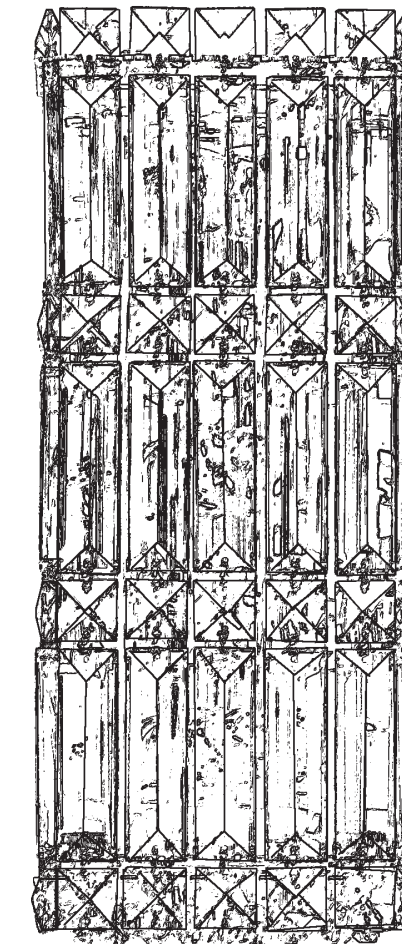

3 Lights
Length: 5-1/2"
Extension: 4-1/2"
Height: 13"
Weight: 6 lbs.

THIS DESIGN IS THE PROPRIETARY TRADE DRESS/TRADEMARK OF W SCHONBEK LLC.



SCHONBEK | 1870

**See diagram on back page
Follow steps in exact order
Save this trim diagram for future reference**

1

IMPORTANT

Person who opens carton should record the following information for future service.

CODE # _____ Four-digit number on outside of carton.
PACKER # _____ See crystal package label.
ORDER # _____ See crystal package label.



Instructions for crystal trimming

STEPS 6 - 8

6

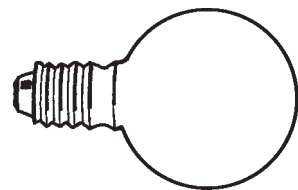

You will need 3 - G11
40 Watts Max
25 Watts recommended
(Supplied - Part #: 30205)

Install bulbs and be sure to test
fixture **BEFORE** trimming.



TOP PLATE

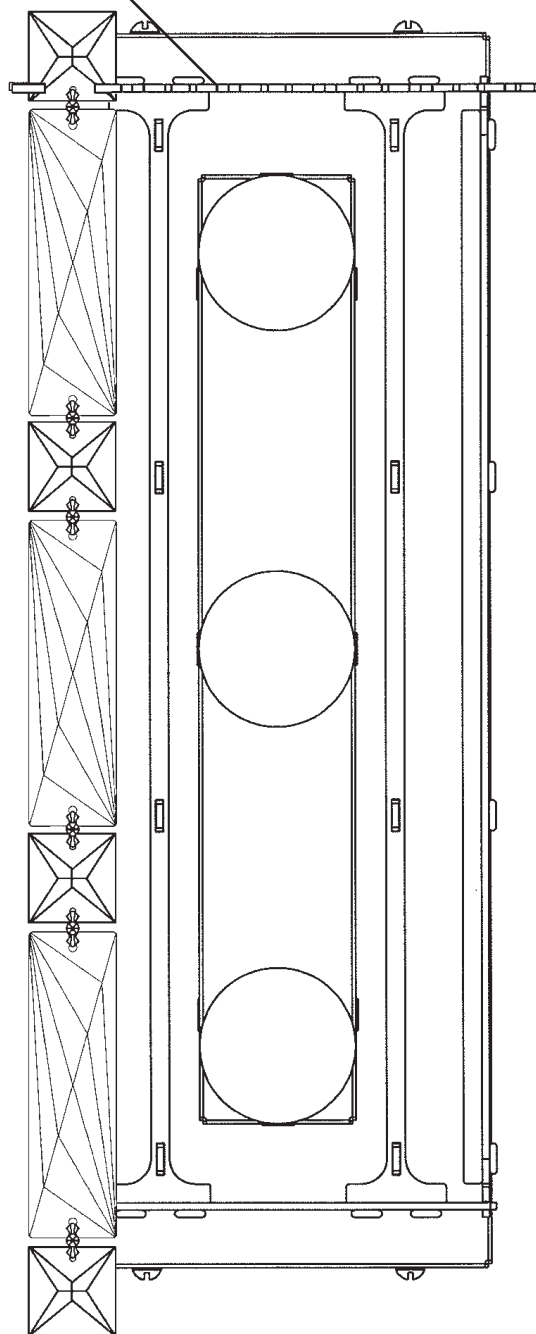

C

THUMB NUT

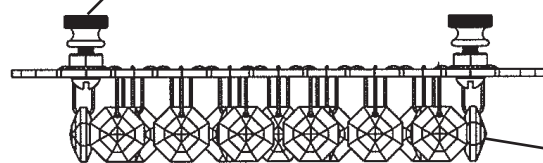

7 Install bottom crystal grid with four thumb nuts (already screwed onto grid) to bottom of the wall sconce.

8 Hold chain "C" by the top square crystal. (NOTE: Flat side of large crystals face out and chains are also symmetrical so either end will work!) Insert bottom square crystal into the pocket of bottom crystal grid. Then position the top connector (between the top two crystals) into the top plate pocket opening directly above the bottom crystal grid pocket. (Diagram #1) Lower the chain until the top square stone seats itself into the top plate pocket. When the chain is installed correctly, it will be held in place by both top and bottom pockets.

DIAGRAM
#1

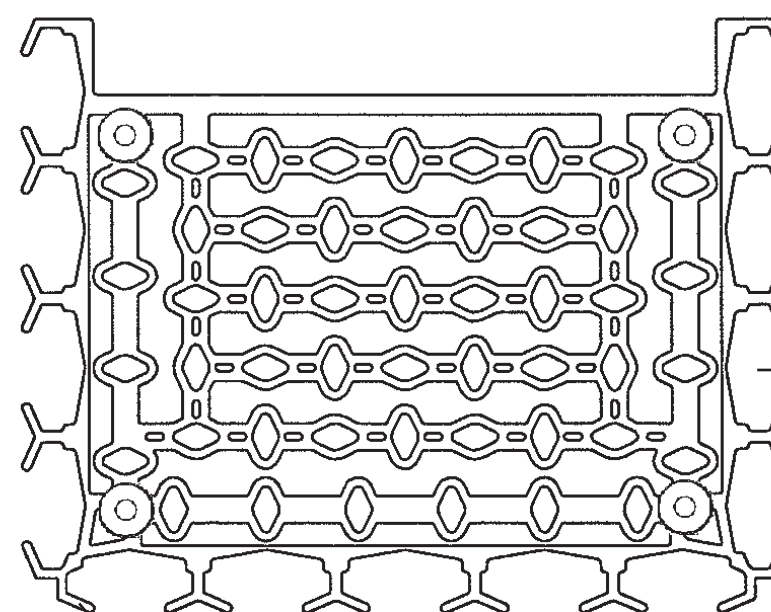
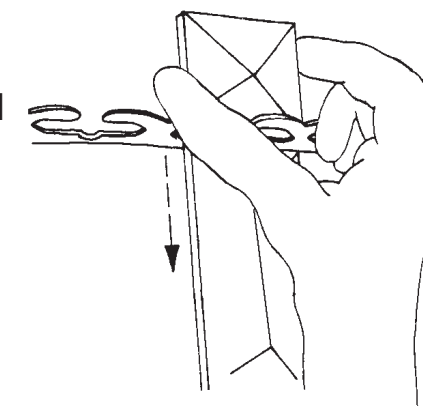

POCKET FOR "C"

BOTTOM
CRYSTAL GRID
#87/354/1SR

Instructions for electrician

STEP 2 - 5

WARNING:

2

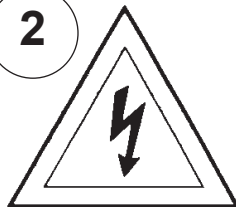

Electrical Danger

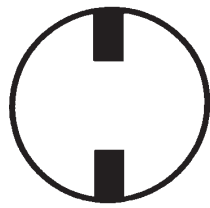

All electrical components must be installed by a licensed electrician in accordance with the National Electric Code and the appropriate local electrical codes.

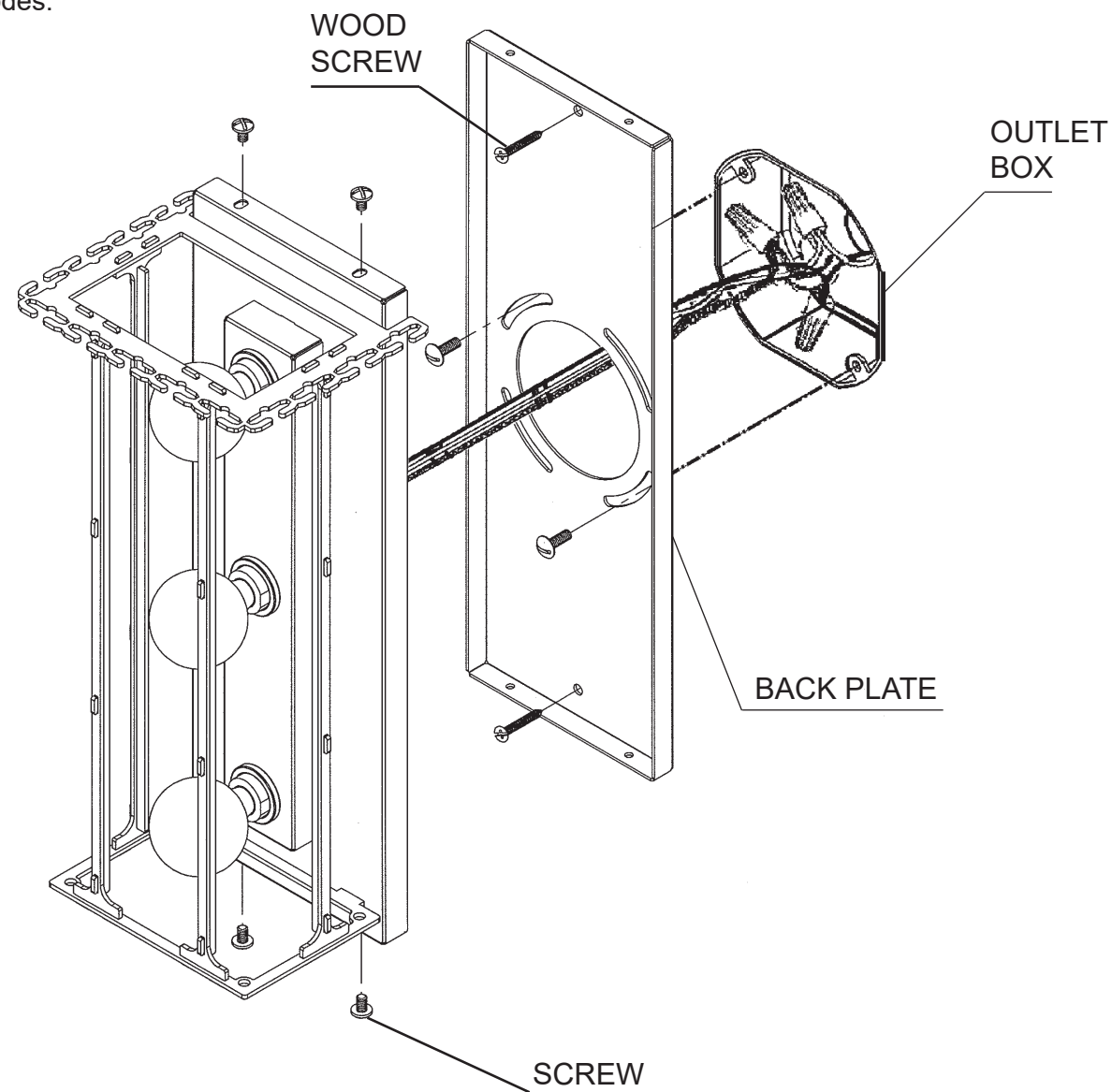

3 Remove the (4) wall sconce screws and separate the back plate from the wall sconce. Feed stem and ground wires through back plate, then attach to power wires and ground wire in outlet box.

4 Attach back plate to the outlet box with (2) screws. Supplied are (2) wood screws to stop the wall sconce from pivoting.

5 Attach wall sconce to back plate and tighten the four screws removed previously.

QUANTUM 2236-___ TRIM DIAGRAM

(Trim Option)

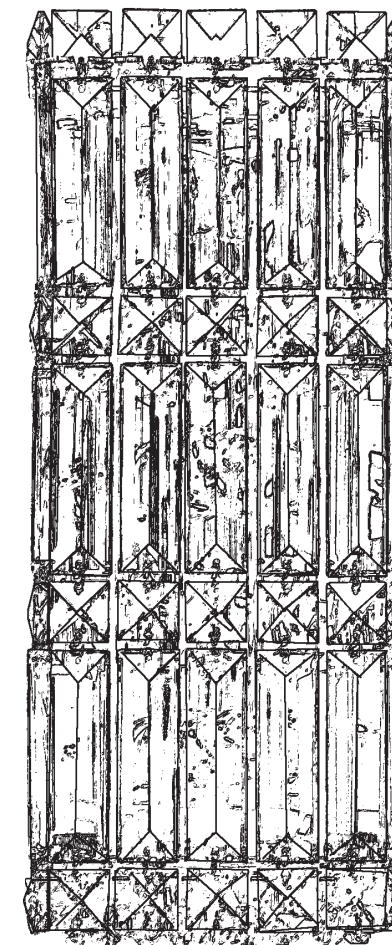

3 Lights
Length: 5-1/2"
Extension: 4-1/2"
Height: 13"
Weight: 6 lbs.

THIS DESIGN IS THE PROPRIETARY TRADE DRESS/TRADemark OF W SCHONBEK LLC.



SCHONBEK

1870

**See diagram on back page
Follow steps in exact order
Save this trim diagram for future reference**

1

IMPORTANT

Person who opens carton should record the following information for future service.

CODE # _____ Four-digit number on outside of carton.
PACKER # _____ See crystal package label.
ORDER # _____ See crystal package label.



Instructions for crystal trimming

STEPS 6 - 8

6

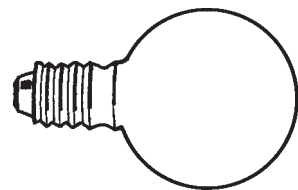

You will need 3 - G11
40 Watts Max
25 Watts recommended
(Supplied - Part #: 30205)

Install bulbs and be sure to test
fixture **BEFORE** trimming.



TOP PLATE

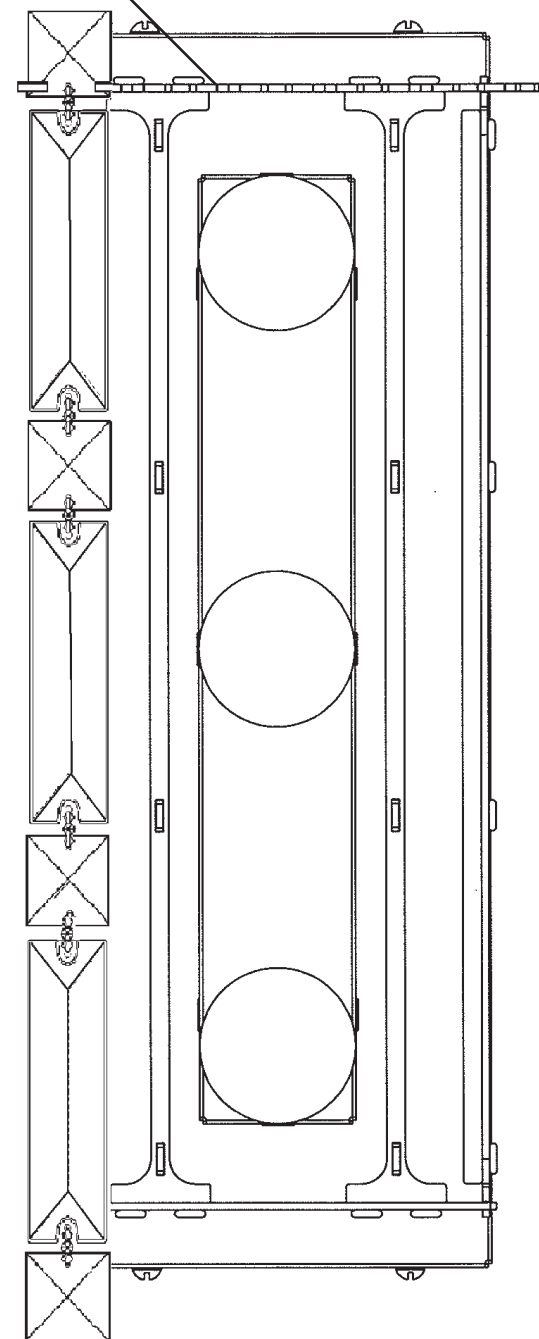

C or C1

THUMB NUT

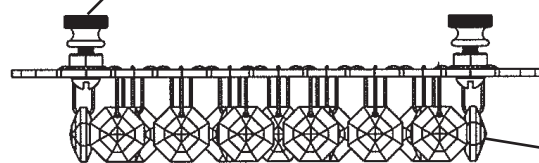

7 Install bottom crystal grid with four thumb nuts (already screwed onto grid) to bottom of the wall sconce.

8 Hold chain "C" by the top square crystal. (NOTE: Flat side of large crystals face out and chains are also symmetrical so either end will work!) When trimming a ST fixture, always start with chain C on either side against the wall, and alternate hanging C & C1 chains. Insert bottom square crystal into the pocket of bottom crystal grid. Then position the top connector (between the top two crystals) into the top plate pocket opening directly above the bottom crystal grid pocket. (Diagram #1) Lower the chain until the top square stone seats itself into the top plate pocket. When the chain is installed correctly, it will be held in place by both top and bottom pockets.

DIAGRAM
#1

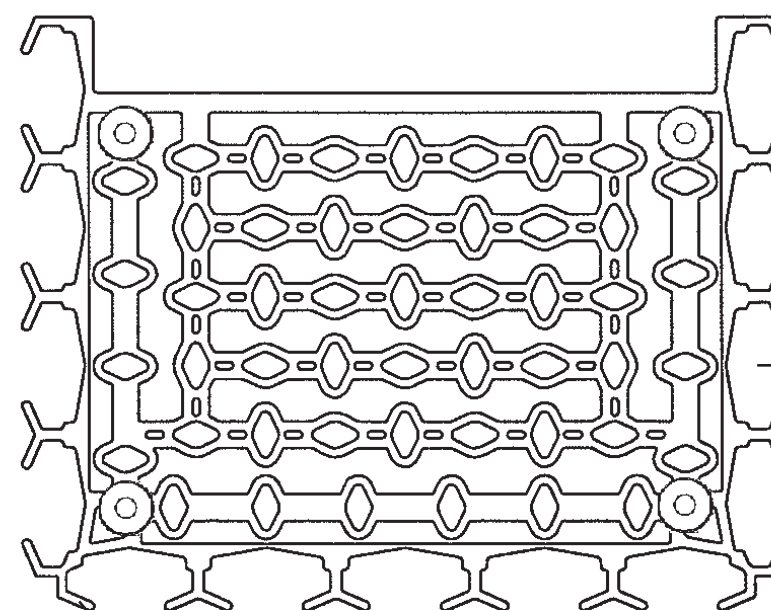
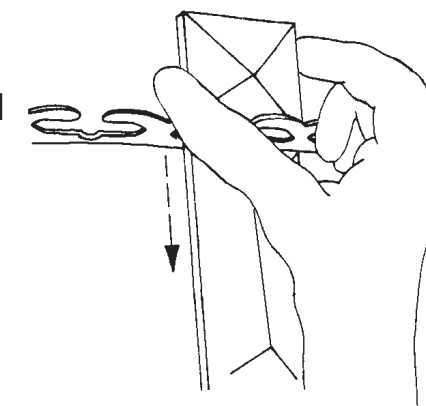

POCKET FOR "C" or "C1"

BOTTOM
CRYSTAL GRID
#87/354/1SS