

STERLING 2994- \_\_\_ \_H

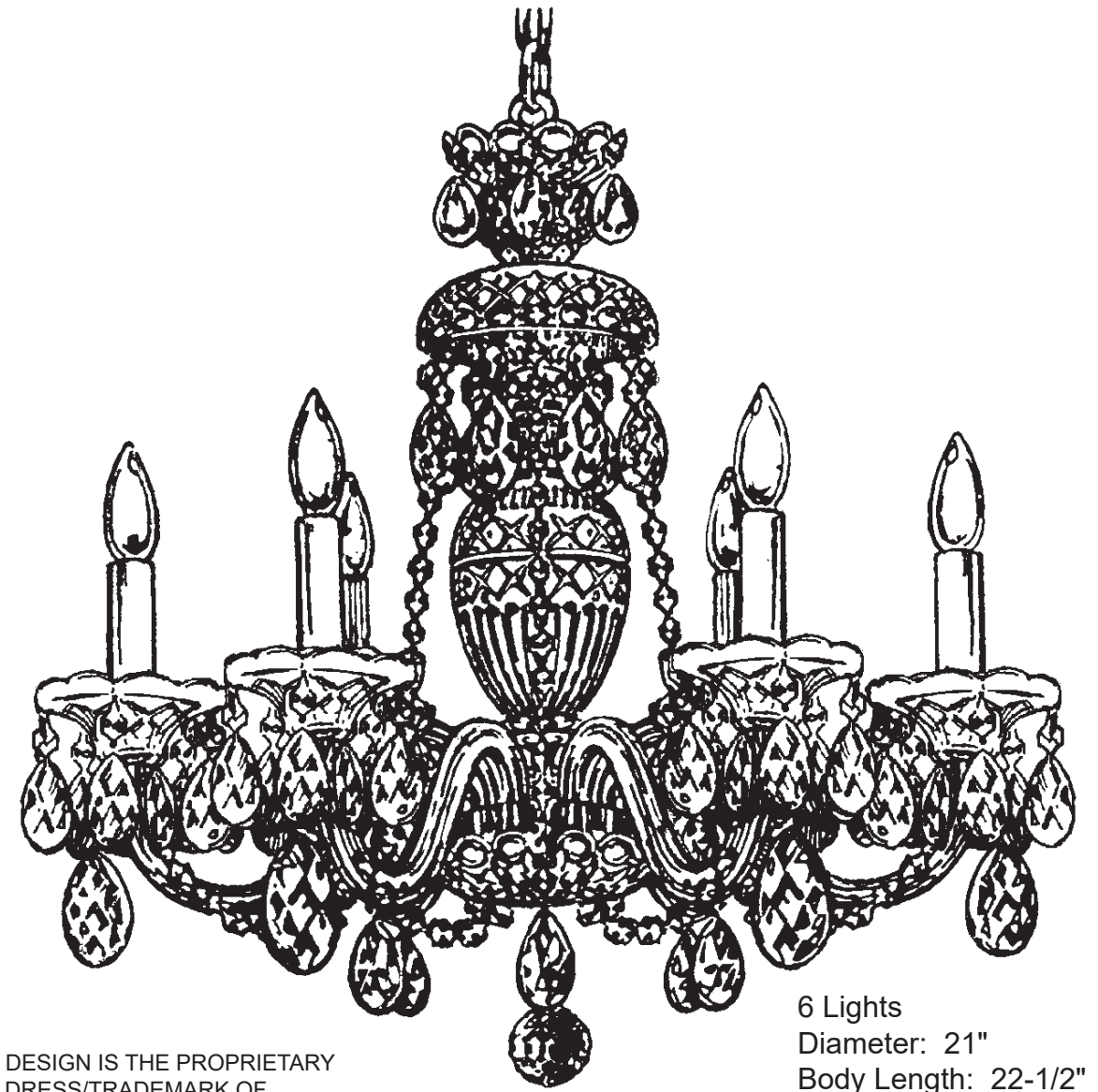











6 Lights  
Diameter: 21"  
Body Length: 22-1/2"  
Hanging Weight: 12 lbs.

**T**HIS DESIGN IS THE PROPRIETARY  
TRADE DRESS/TRADEMARK OF  
W SCHONBEK LLC.

 **SCHONBEK** | 1870

 **SCHONBEK** | 1870

								
MAX <b>60</b> W		110-120 V						

All electrical components must be installed by a licensed electrician in accordance with the National Electric Code and the appropriate local electrical codes.

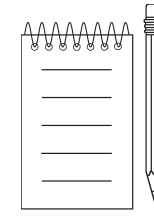
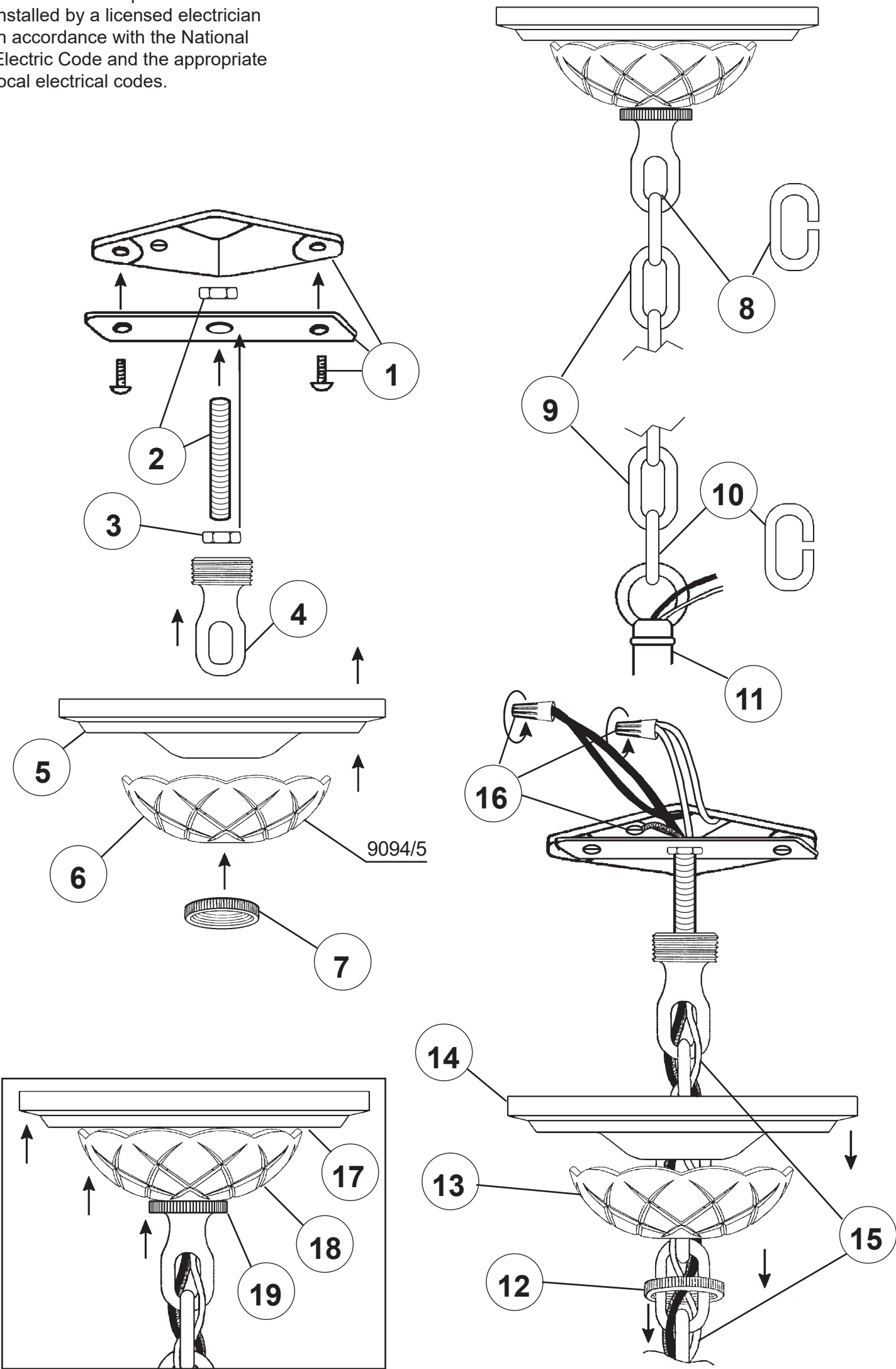

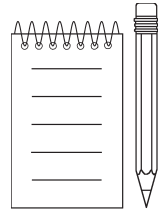



21

You will need 6 - B10  
25 Watts Recommended  
60 Watts Max

Install bulbs and be sure  
to test fixture **BEFORE**  
trimming.

20 Install arms into washer. Line up holes in arms with stud in washer. Use lock washer and nut to secure arms in place. Connect ground wire in each arm to ground wire in center column. **NO MORE THAN 5-WIRES PER WIRE NUT.** Use electrical tape to secure wire nuts. Connect white arm wires to neutral column wire (ribbed or marked is neutral). Connect black arm wires to the power wire in column. Carefully press wires as close as possible to the underside of washer. Attach metal enclosure with nut provided. Attach #9319 glass with rosette and ball.

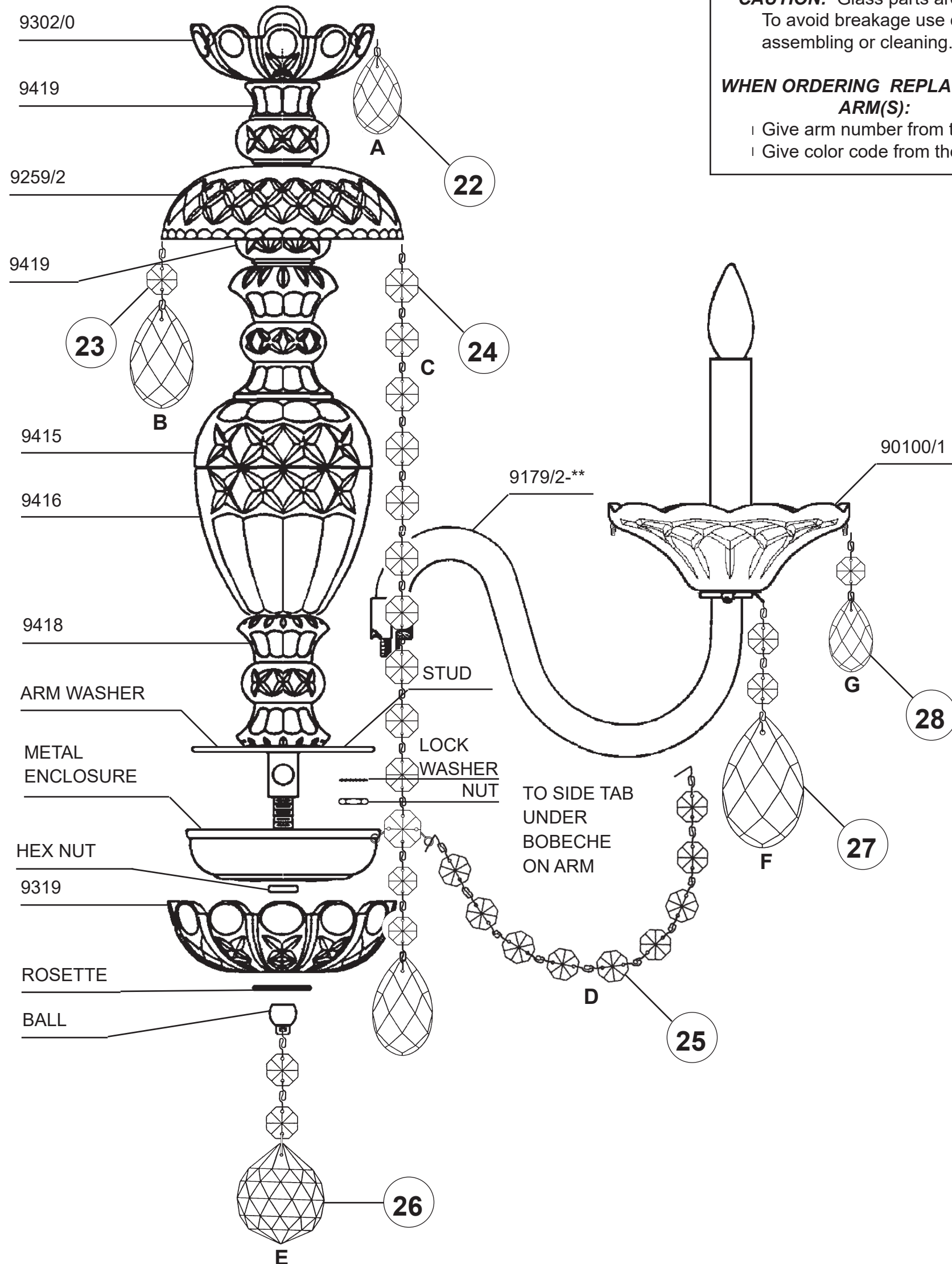

**CAUTION:** Glass parts are fragile.  
To avoid breakage use care when  
assembling or cleaning.

COLOR →

**WHEN ORDERING REPLACEMENT  
ARM(S):**

- ! Give arm number from trim diagram
- ! Give color code from the arm itself

