

STERLING 2996- ___ H













THIS DESIGN IS THE PROPRIETARY TRADE DRESS/TRADemark OF W SCHONBEK LLC.

9 Lights
Diameter: 27"
Body Length: 31"
Hanging Weight: 24 lbs.

 **SCHONBEK** | 1870

 **SCHONBEK** | 1870

								
MAX 60 W	110-120 V							

All electrical components must be installed by a licensed electrician in accordance with the National Electric Code and the appropriate local electrical codes.

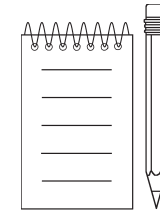
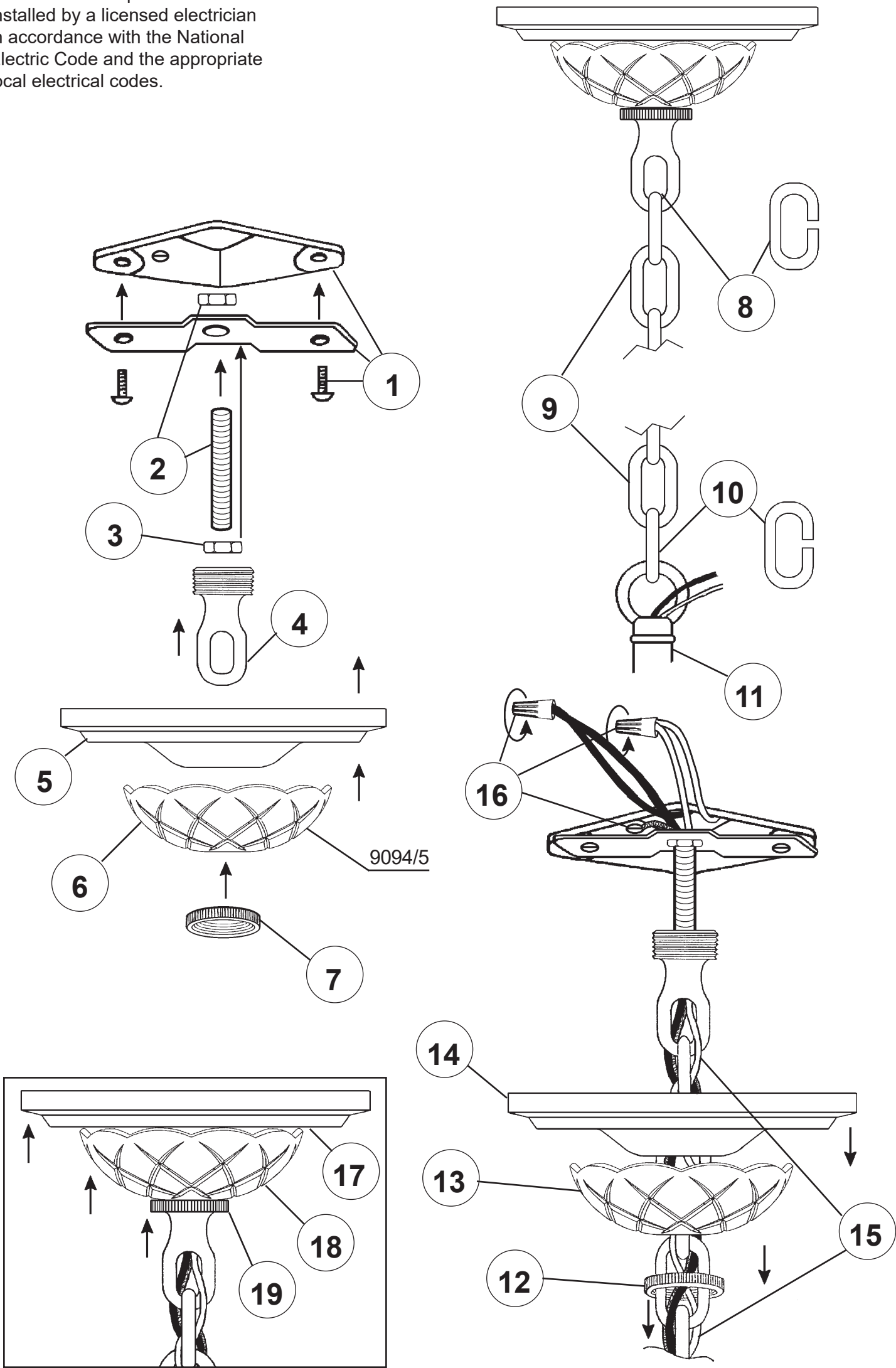





21

You will need 9 - B10
25 Watts Recommended
60 Watts Max

Install bulbs and be sure
to test fixture **BEFORE**
trimming.

20 Install arms into washer. Line up holes in arms with stud in washer. Use lock washer and nut to secure arms in place. Connect ground wire in each arm to ground wire in center column. **NO MORE THAN 5-WIRES PER WIRE NUT.** Use electrical tape to secure wire nuts. Connect white arm wires to neutral column wire (ribbed or marked is neutral). Connect black arm wires to the power wire in column. Carefully press wires as close as possible to the underside of washer. Attach glass assembly with rosette and ball.

