

 **SCHONBEK** | 1870











STERLING 2999- ___ H



THIS DESIGN IS THE PROPRIETARY TRADE DRESS/TRADEMARK OF W SCHONBEK LLC.

5 Lights
Diameter: 16"
Body Length: 17-1/2"
Hanging Weight: 10 lbs.

 **SCHONBEK** | 1870

								
MAX 60 W	110-120 V							

All electrical components must be installed by a licensed electrician in accordance with the National Electric Code and the appropriate local electrical codes.

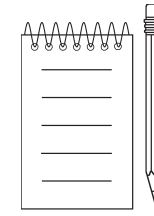
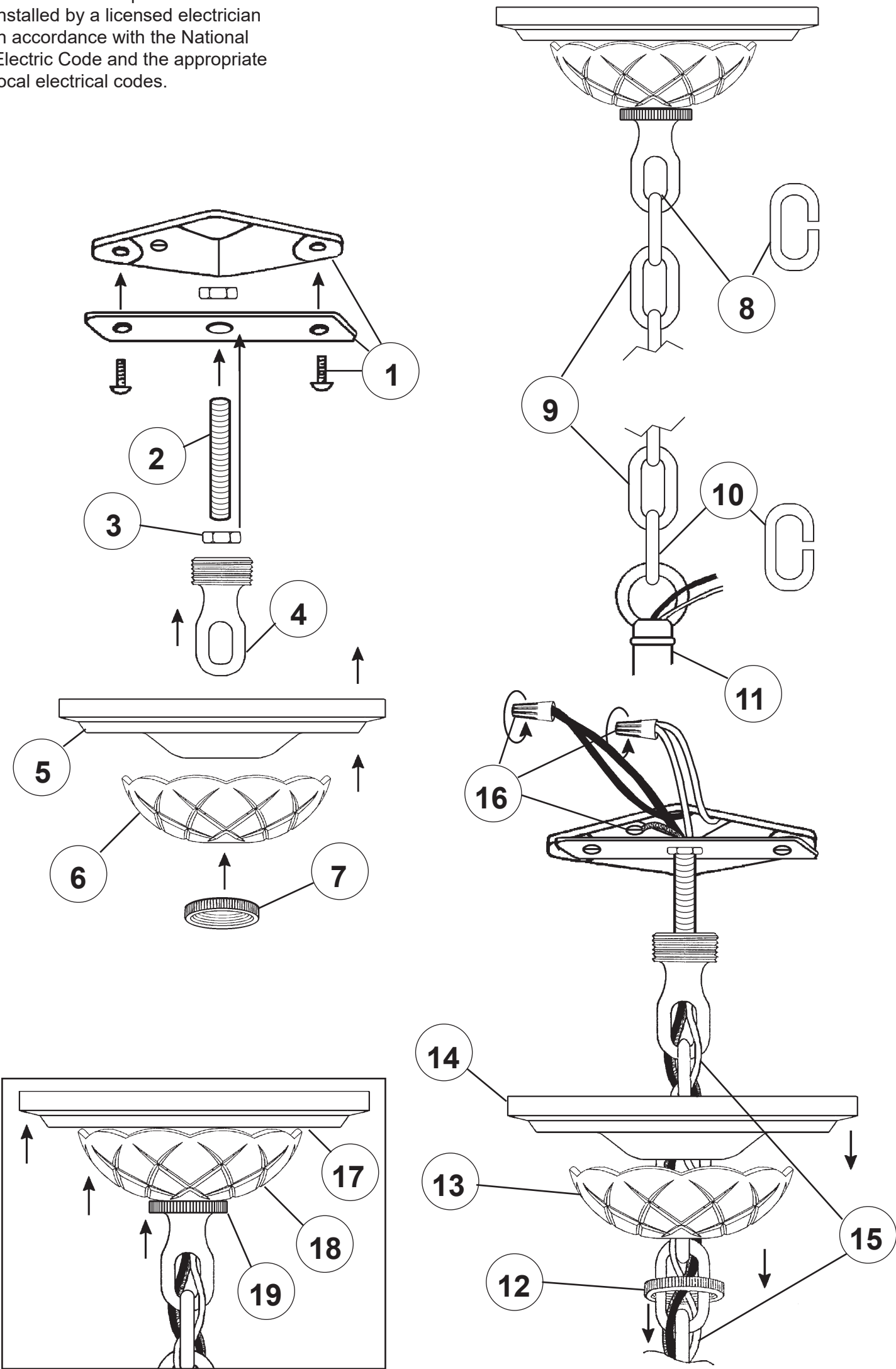





21

You will need 5 - B10
25 Watts Recommended
60 Watts Max

**Install bulbs and be sure
to test fixture BEFORE
trimming.**

20 Install arms into the holes on the washer. Line up holes in arms with dimple in washer. Use lock tapered nut to secure arms in place.



**This end goes up
against washer.**

Connect ground wire in each arm to ground wire in center column. **NO MORE THAN 5-WIRES PER WIRE NUT.** Use electrical tape to secure wire nuts. Connect white arm wires to neutral column wire (ribbed or marked is neutral). Connect black arm wires to the power wire in column. Carefully press wires as close as possible to the underside of washer. Install bobeches, bulbs, connect power and test the fixture **BEFORE** attaching glass assembly. If any of the bulbs do **NOT** light - **DISCONNECT POWER.** Double check the wire connections. Install running thread into hex coupling. Attach glass assembly with rosette, round nut and ball.

CAUTION: Glass parts are fragile. To avoid breakage use care when assembling or cleaning.

COLOR →

**WHEN ORDERING REPLACEMENT
ARM(S):**

- ! Give arm number from trim diagram
- ! Give color code from the arm itself

