

# RENAISSANCE 3572- \_\_\_\_\_

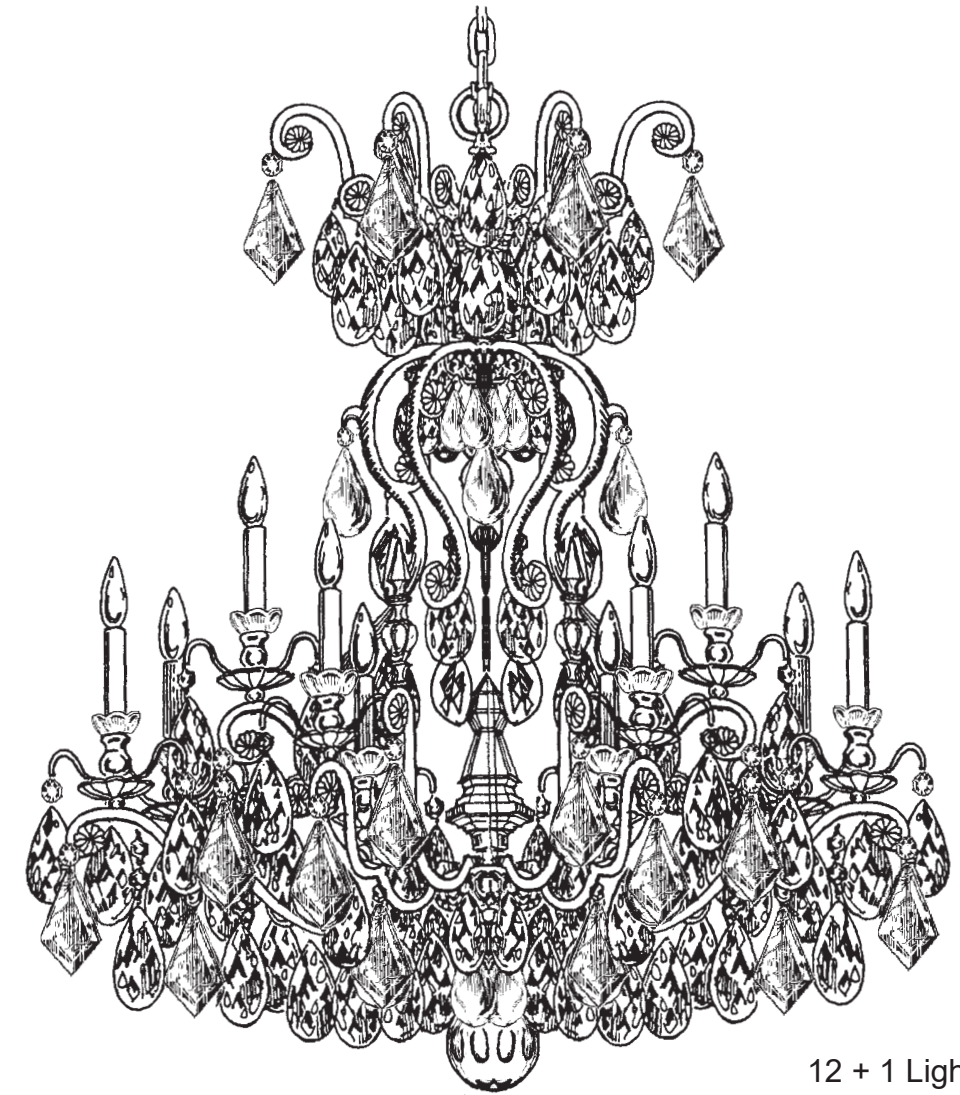











12 + 1 Lights  
Diameter: 32"  
Body Length: 40"  
Hanging Weight: 60 lbs.

**T**HIS DESIGN IS THE PROPRIETARY  
TRADE DRESS/TRADEMARK OF  
W SCHONBEK LLC.

 **SCHONBEK** | 1870

 **SCHONBEK** | 1870

								
MAX 60 W	MAX 15 W	110-120 V						

All electrical components must be installed by a licensed electrician in accordance with the National Electric Code and the appropriate local electrical codes.

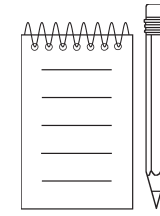
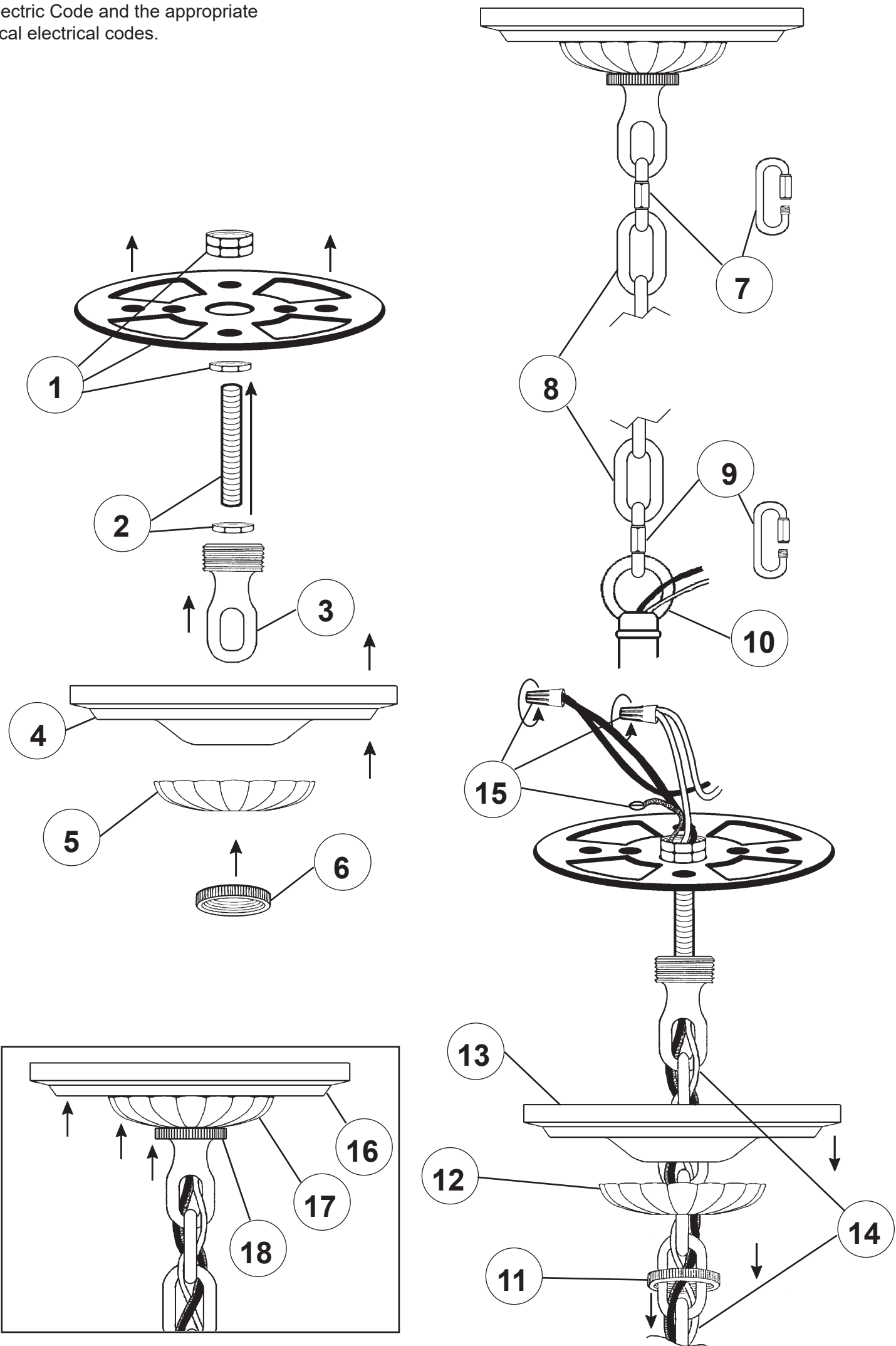

**Crystal Set 3 in Black**

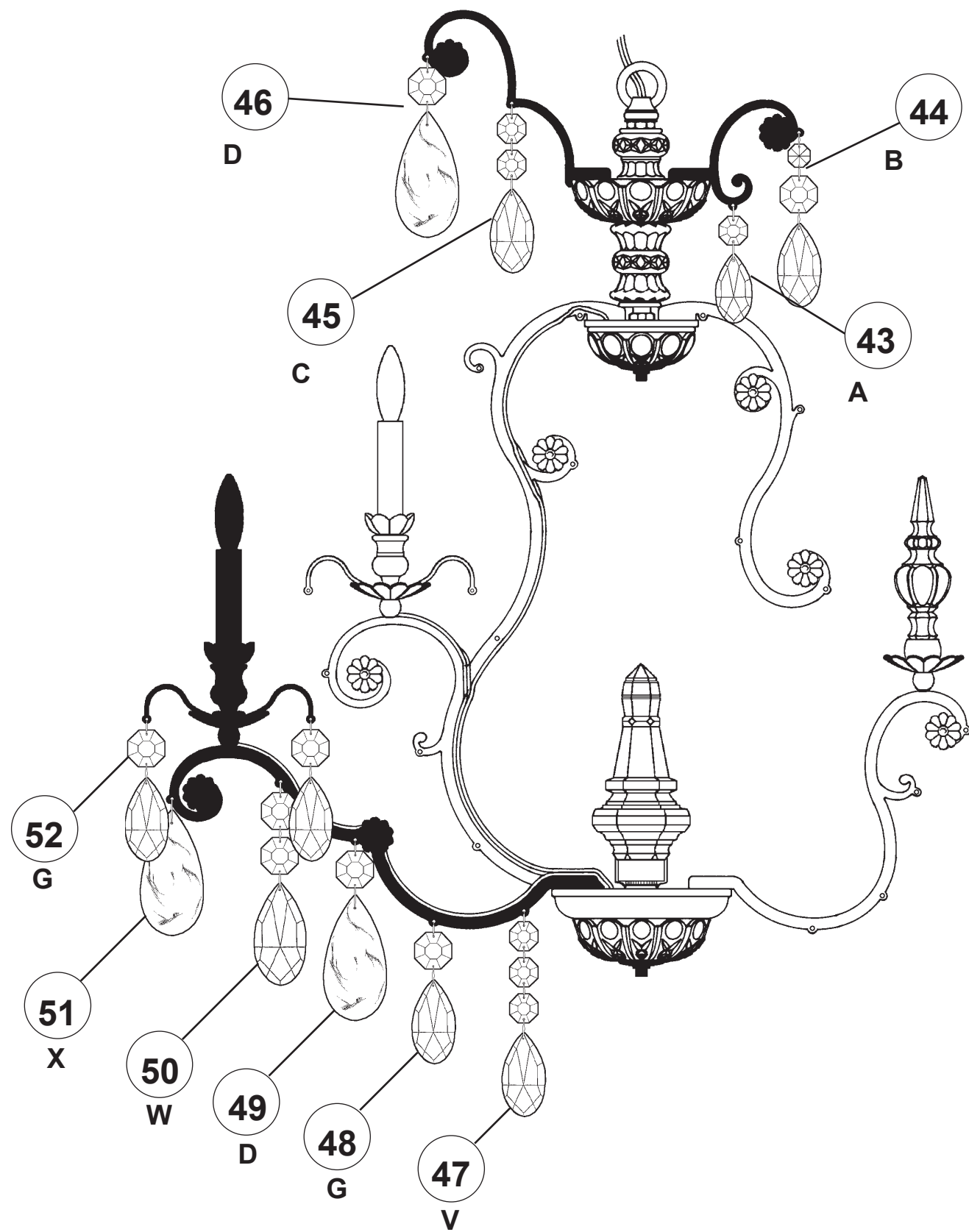

**SET 1**

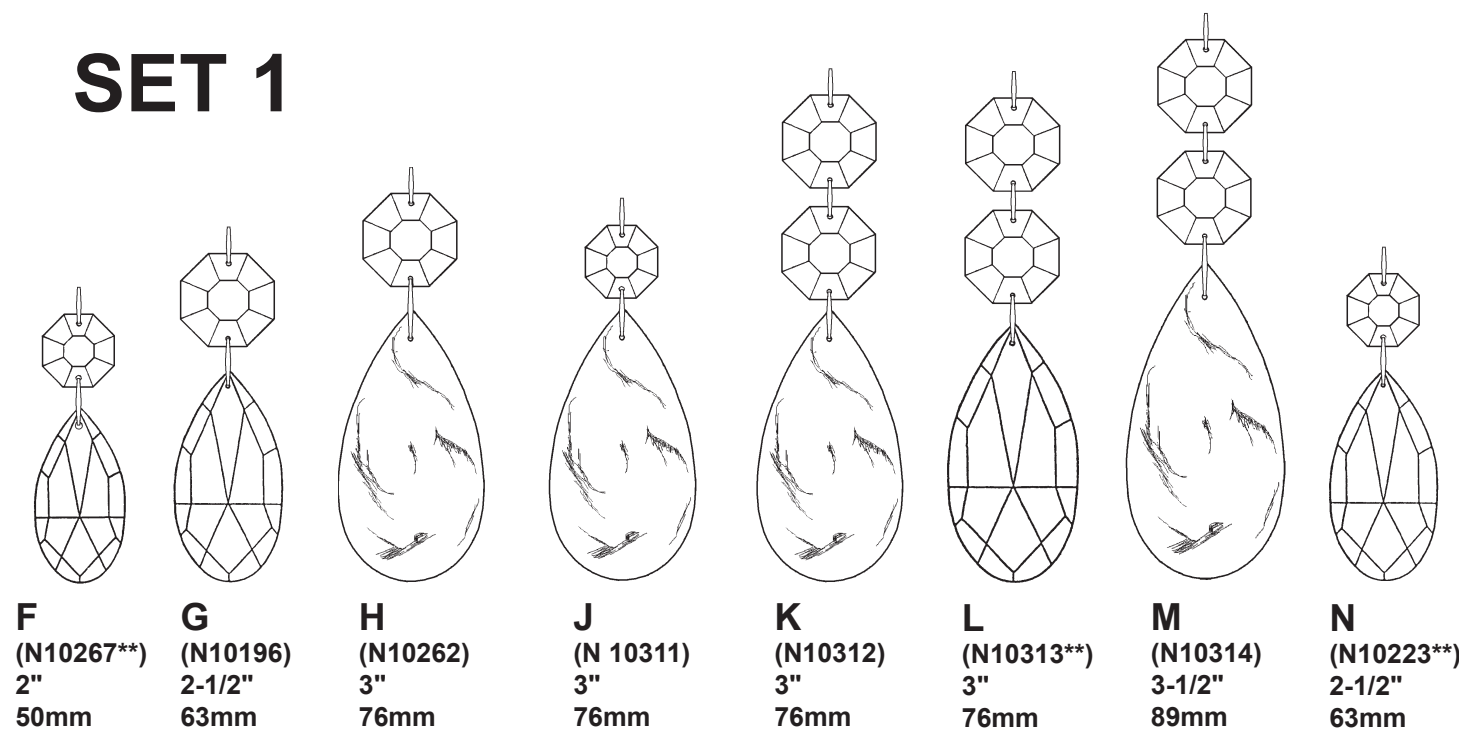

**SET 2**

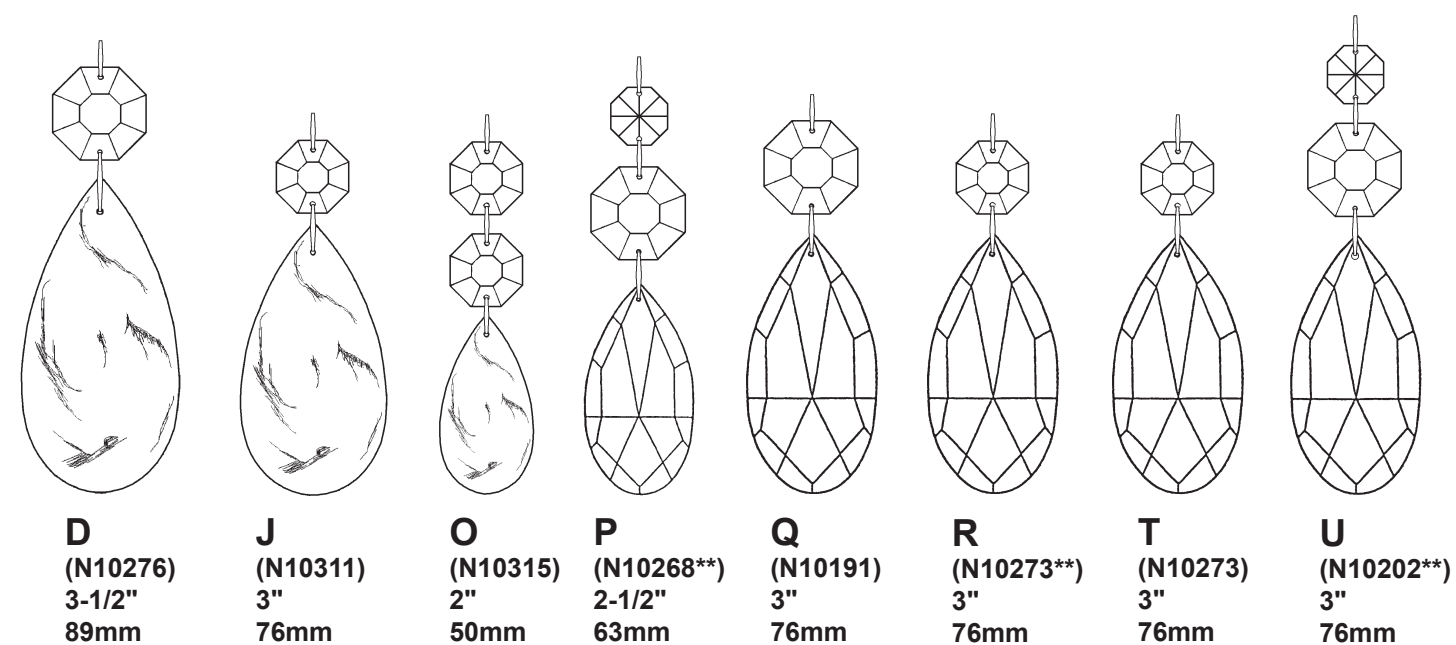

**SET 3**

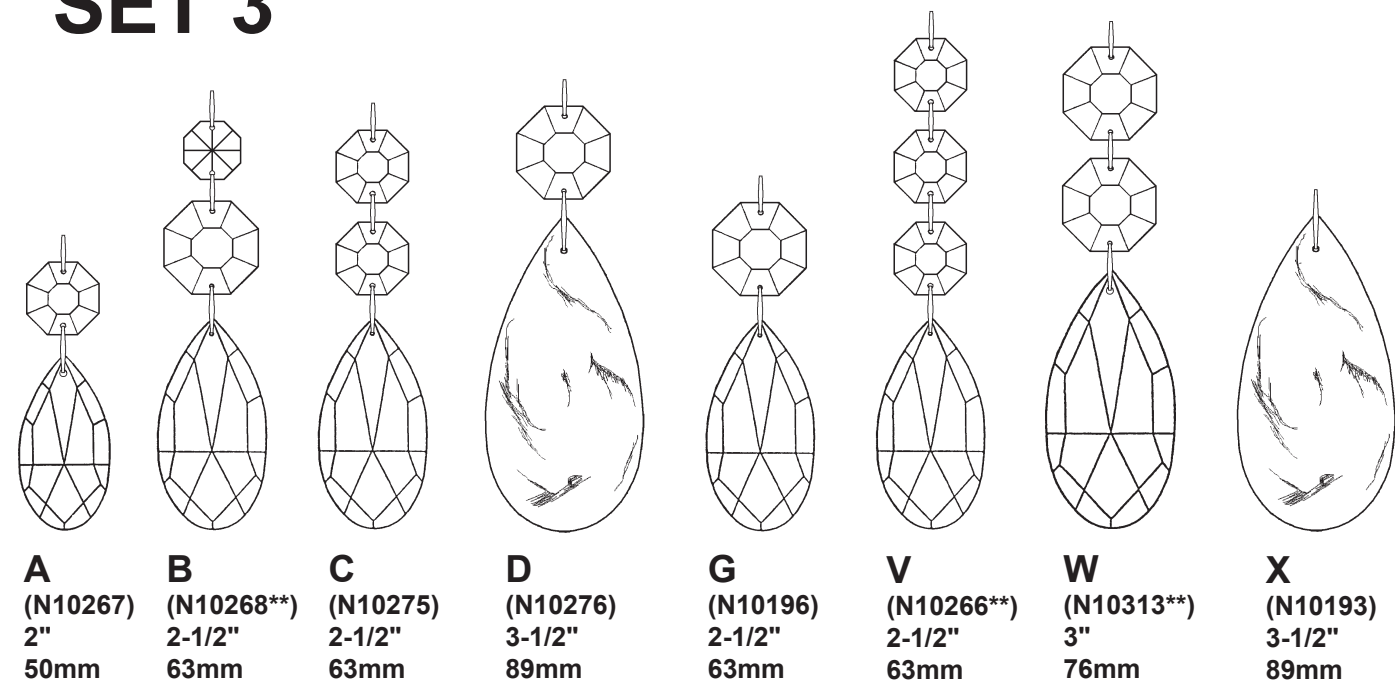

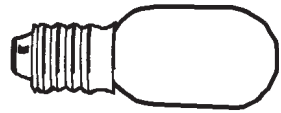

You will need 1 - T7  
15 Watts Max  
(Center Light)

20



You will need 12 - B10  
25 Watts Recommended  
60 Watts Max

Install bulbs and be  
sure to test fixture  
BEFORE trimming.

### Crystal Set 1 in Black

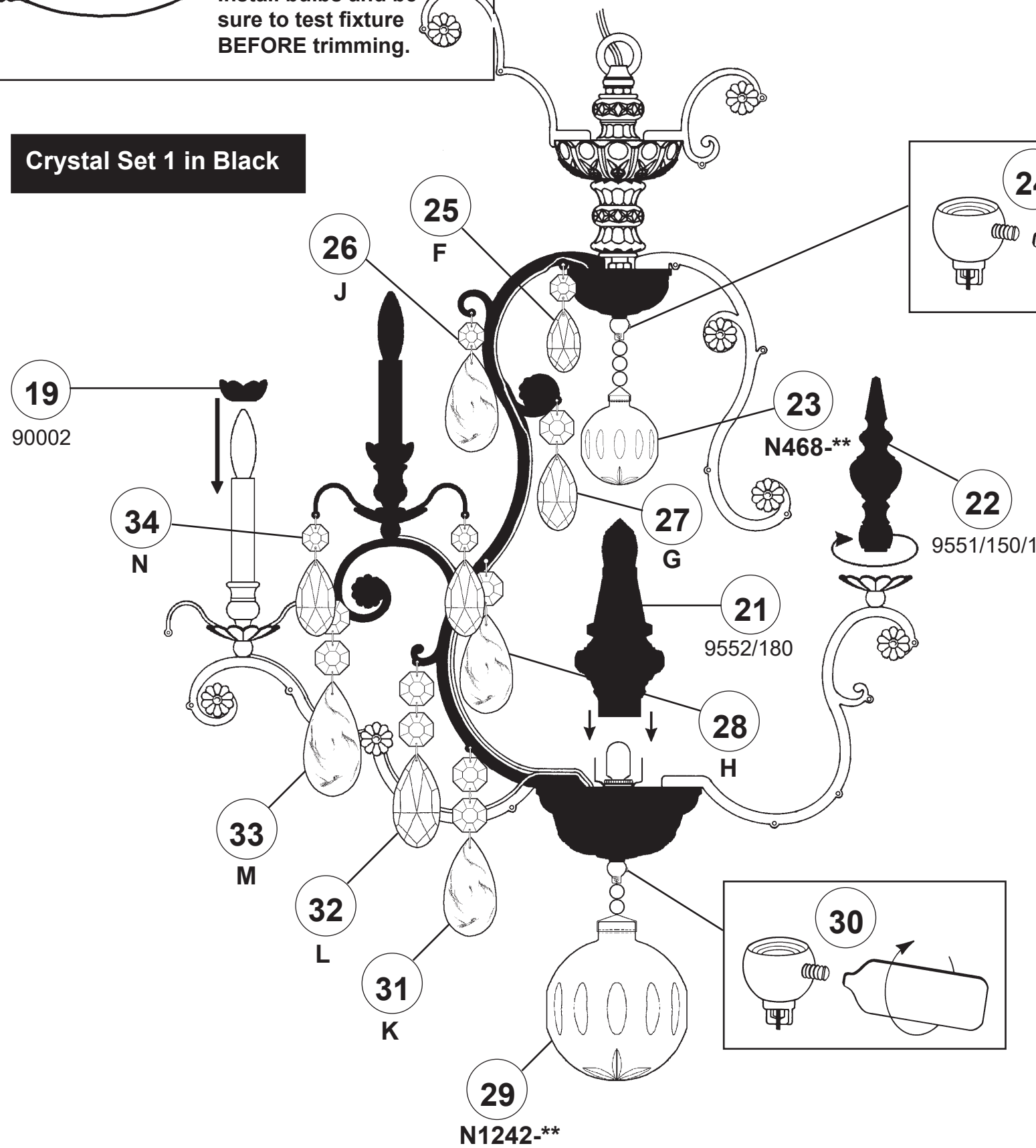

### Crystal Set 2 in Black

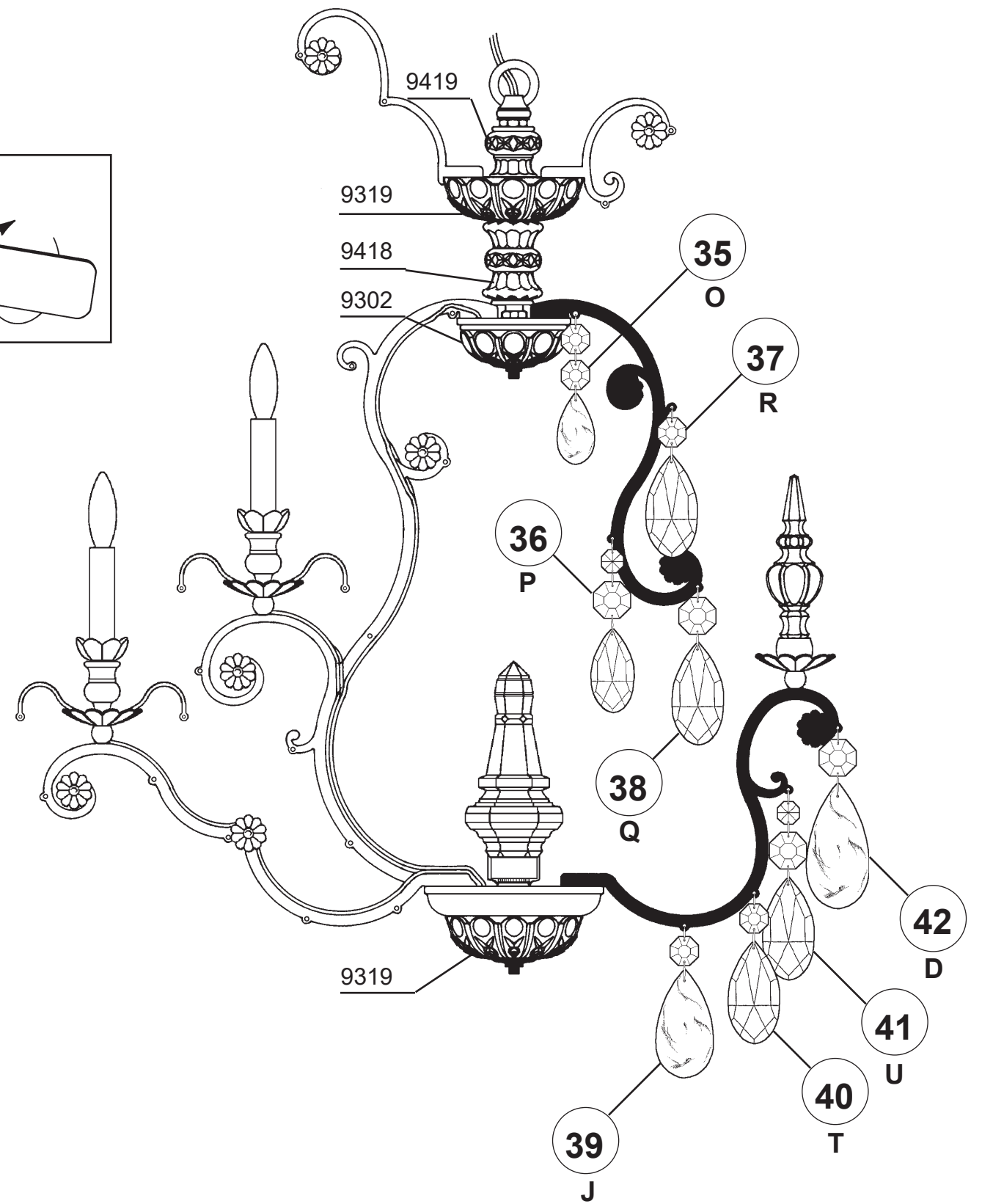

# RENAISSANCE 3572- \_\_\_\_\_

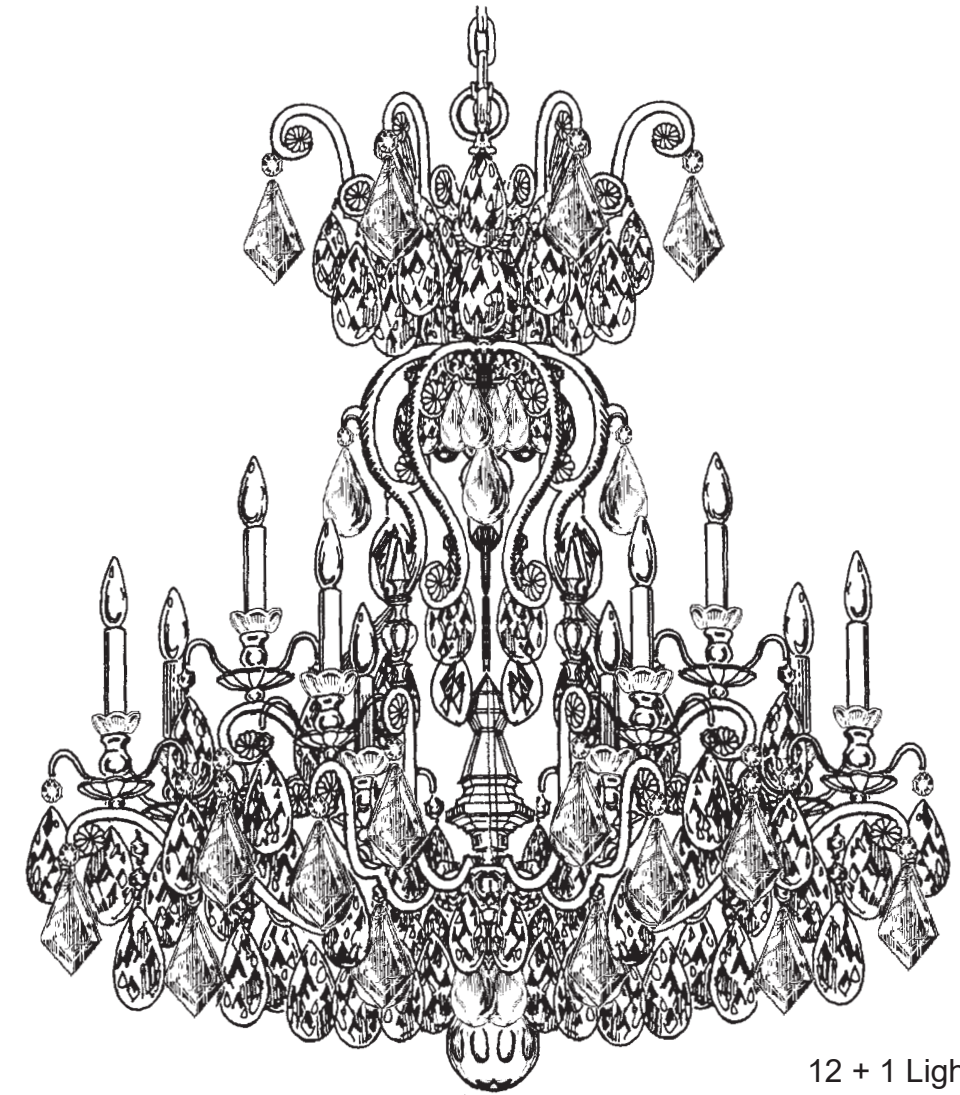











12 + 1 Lights  
Diameter: 32"  
Body Length: 40"  
Hanging Weight: 60 lbs.

**T**HIS DESIGN IS THE PROPRIETARY  
TRADE DRESS/TRADEMARK OF  
W SCHONBEK LLC.

 **SCHONBEK** | 1870

 **SCHONBEK** | 1870

								
MAX 60 W	MAX 15 W	110-120 V						

All electrical components must be installed by a licensed electrician in accordance with the National Electric Code and the appropriate local electrical codes.

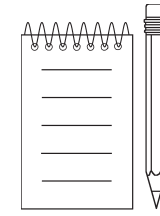
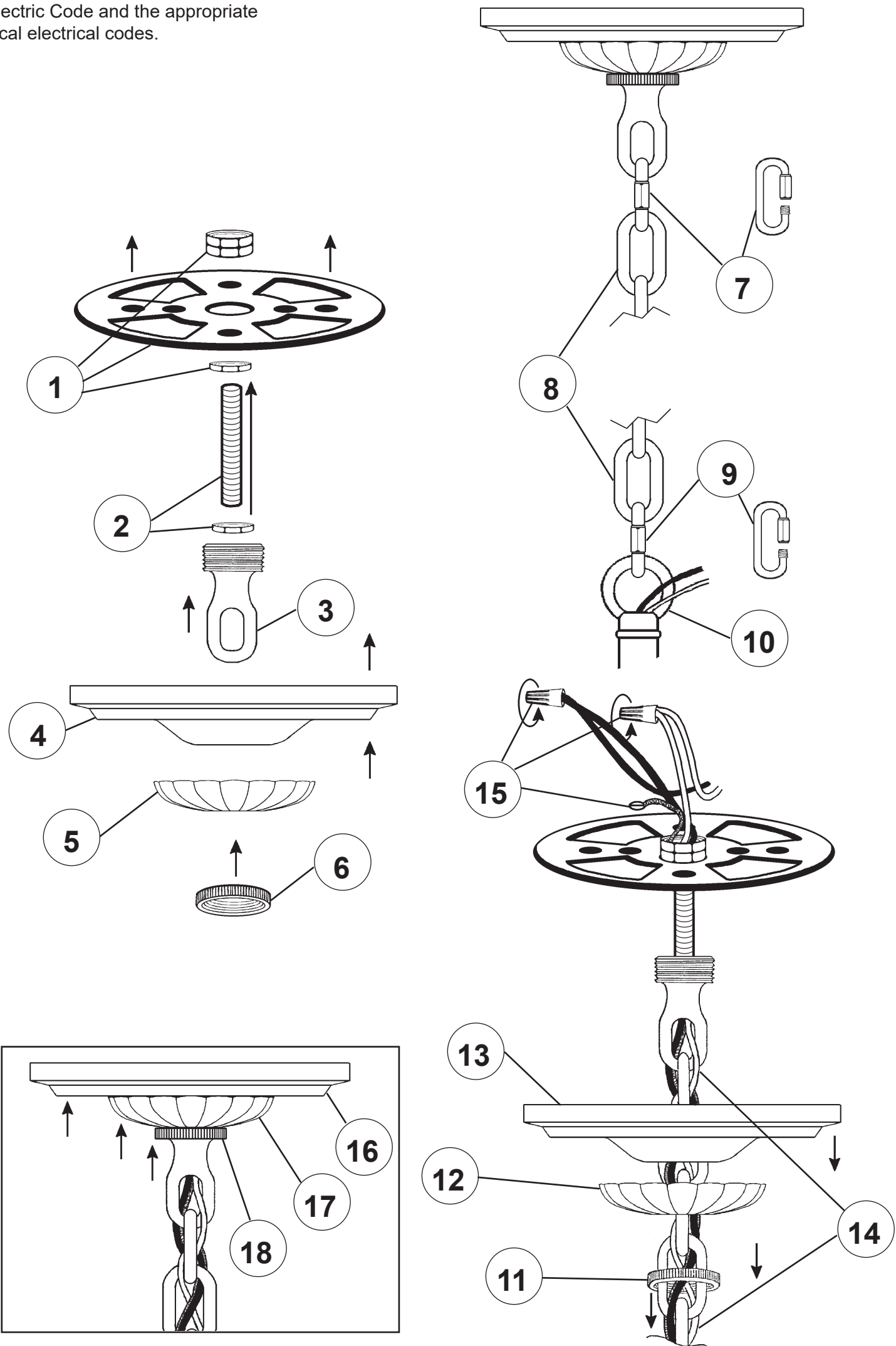

**Crystal Set 3 in Black**

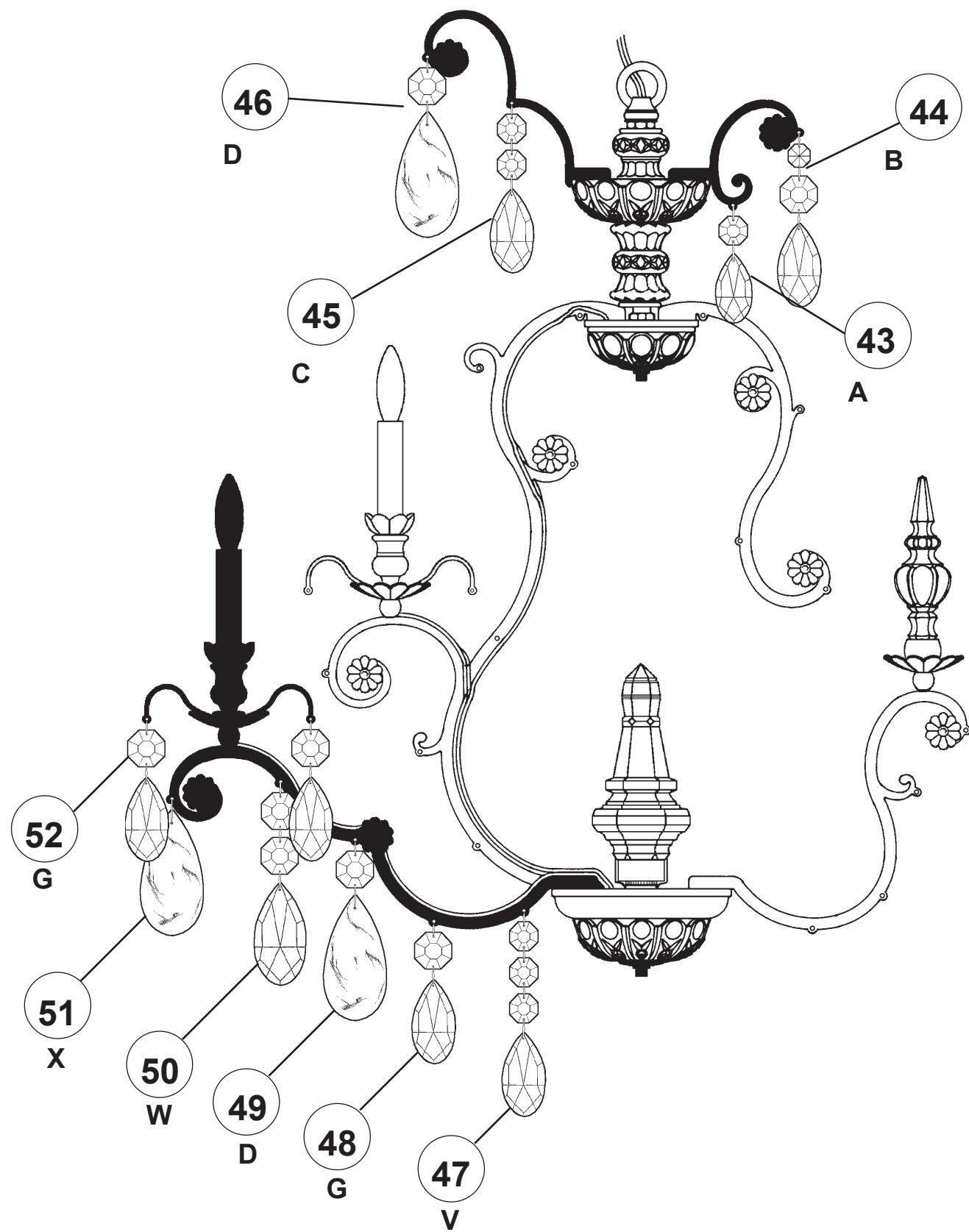

**SET 1**

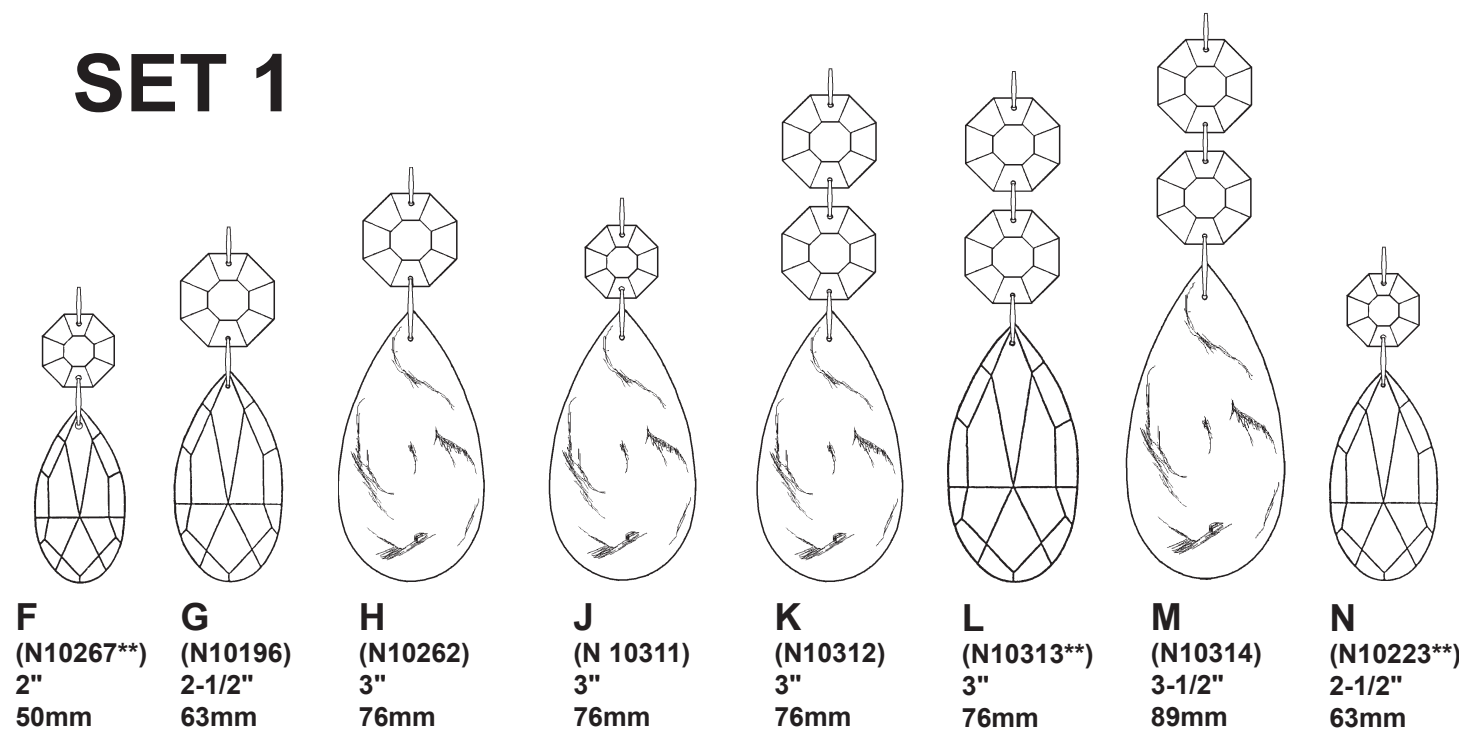

**SET 2**

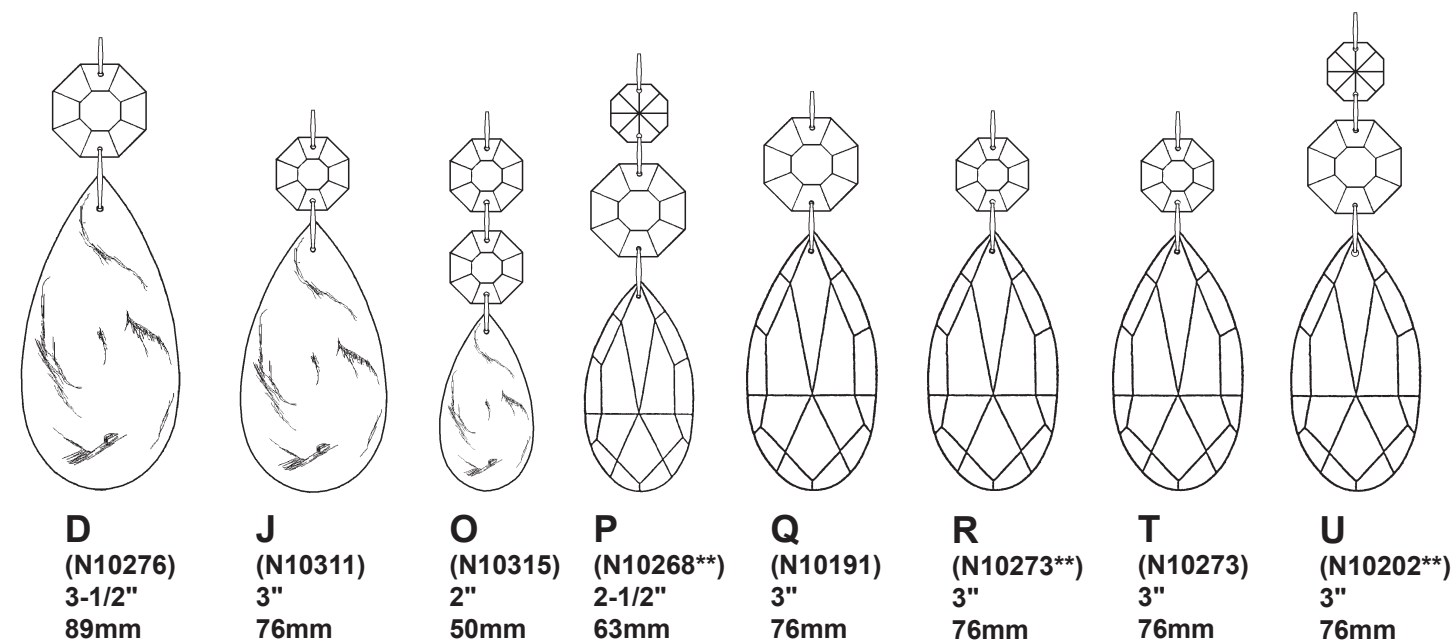

**SET 3**

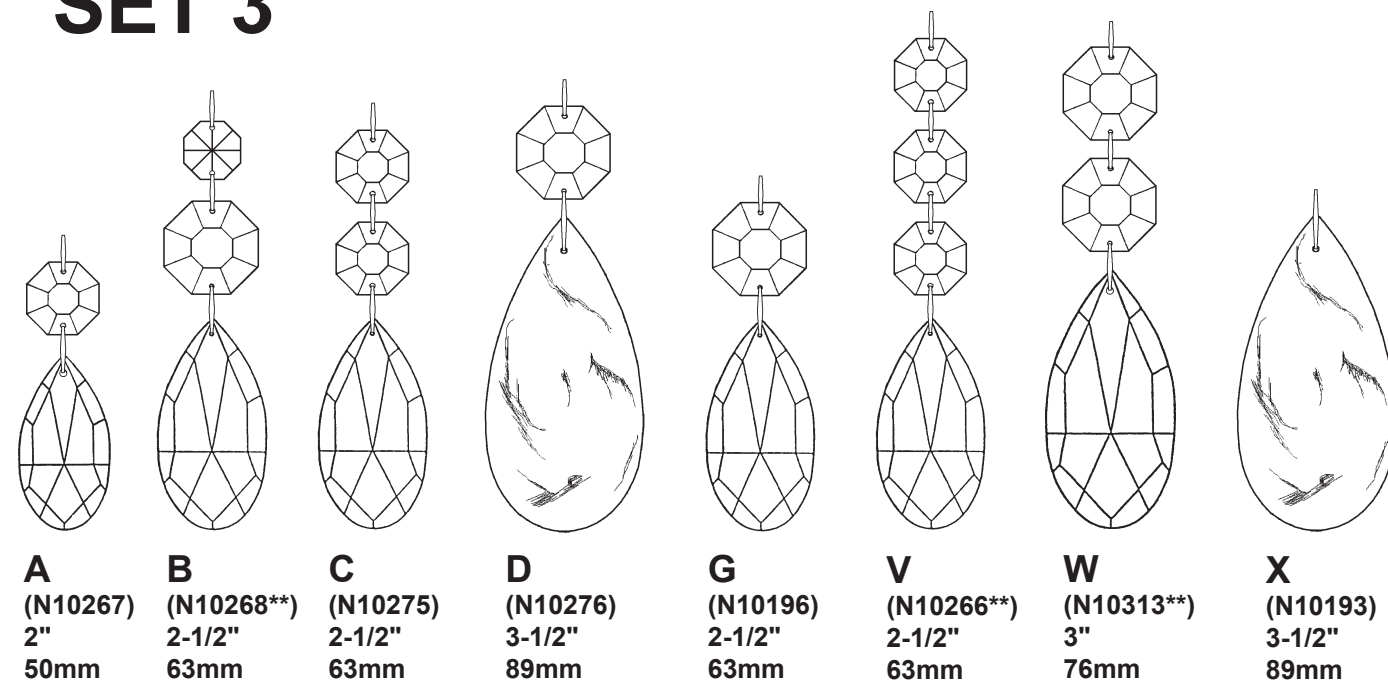

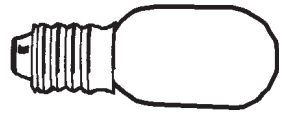

You will need 1 - T7  
15 Watts Max  
(Center Light)

20

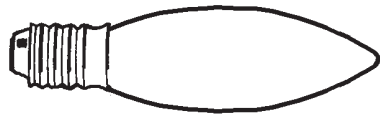

You will need 12 - B10  
25 Watts Recommended  
60 Watts Max

Install bulbs and be  
sure to test fixture  
BEFORE trimming.

### Crystal Set 1 in Black

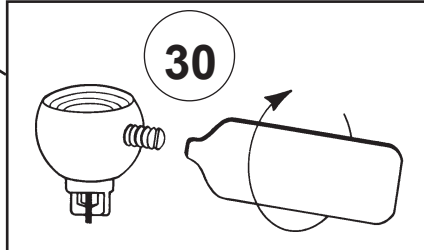
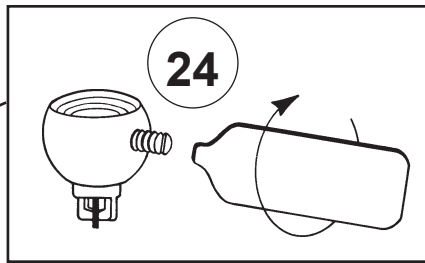
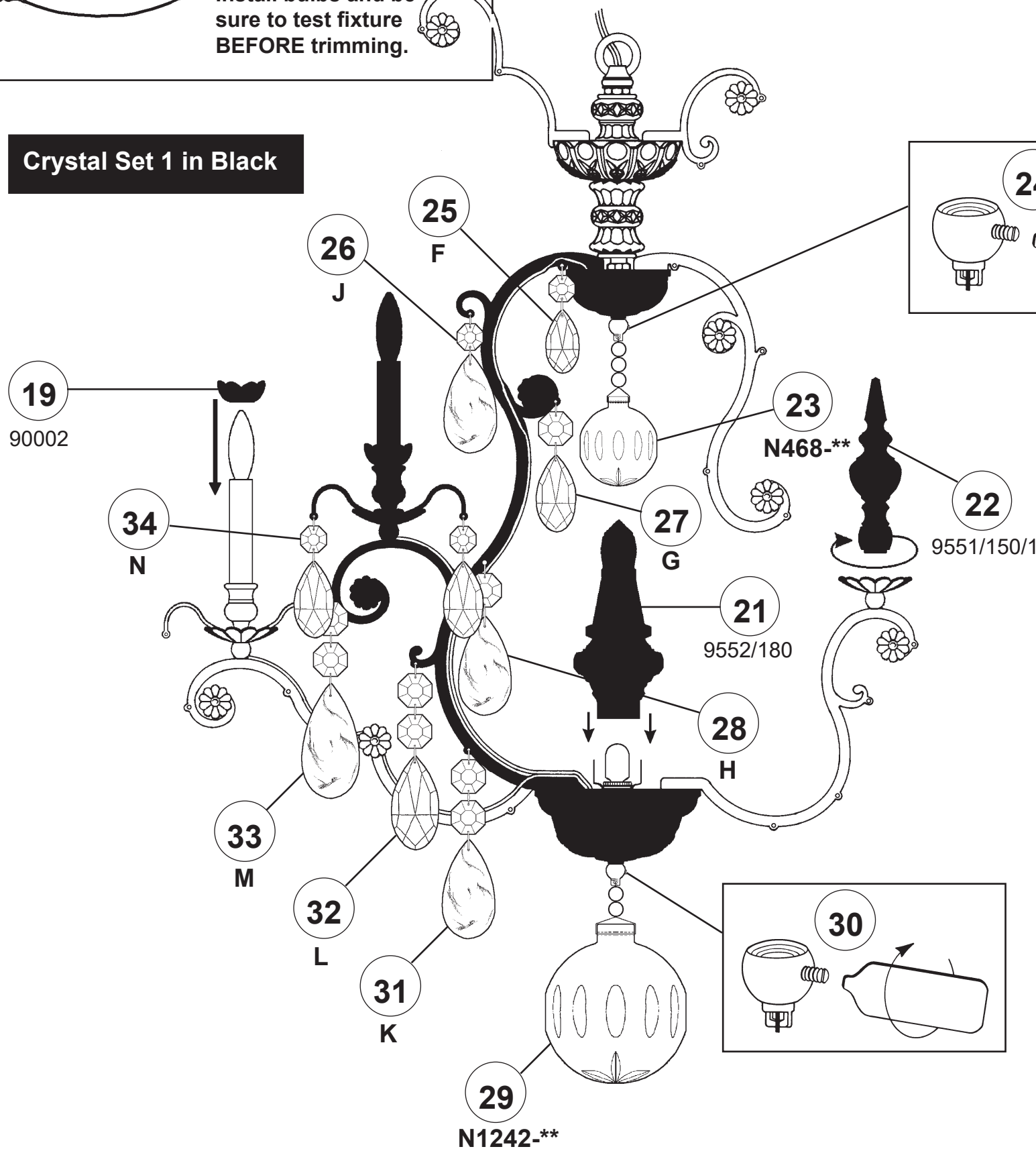

### Crystal Set 2 in Black

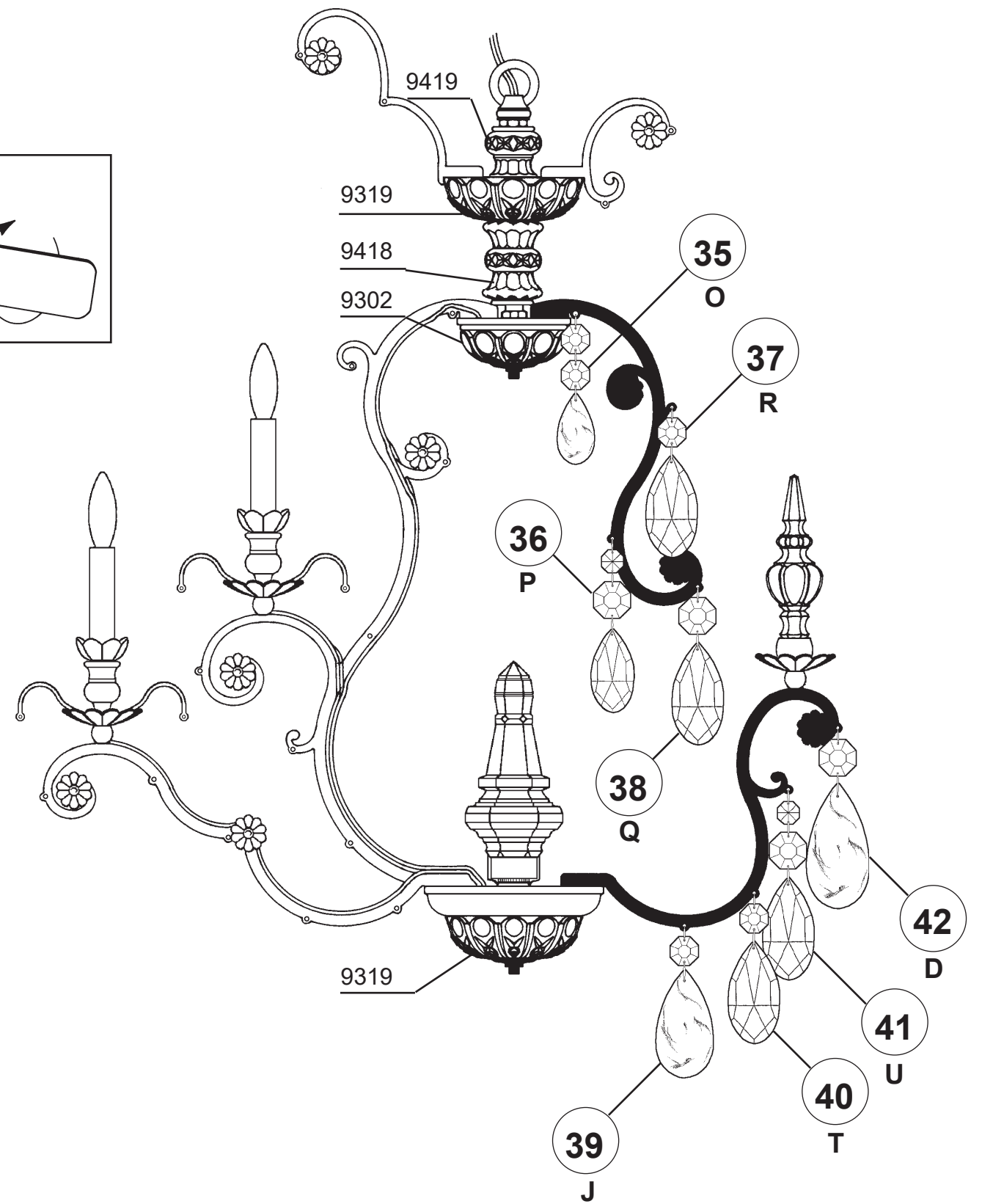



# RENAISSANCE 3572- \_\_\_\_\_

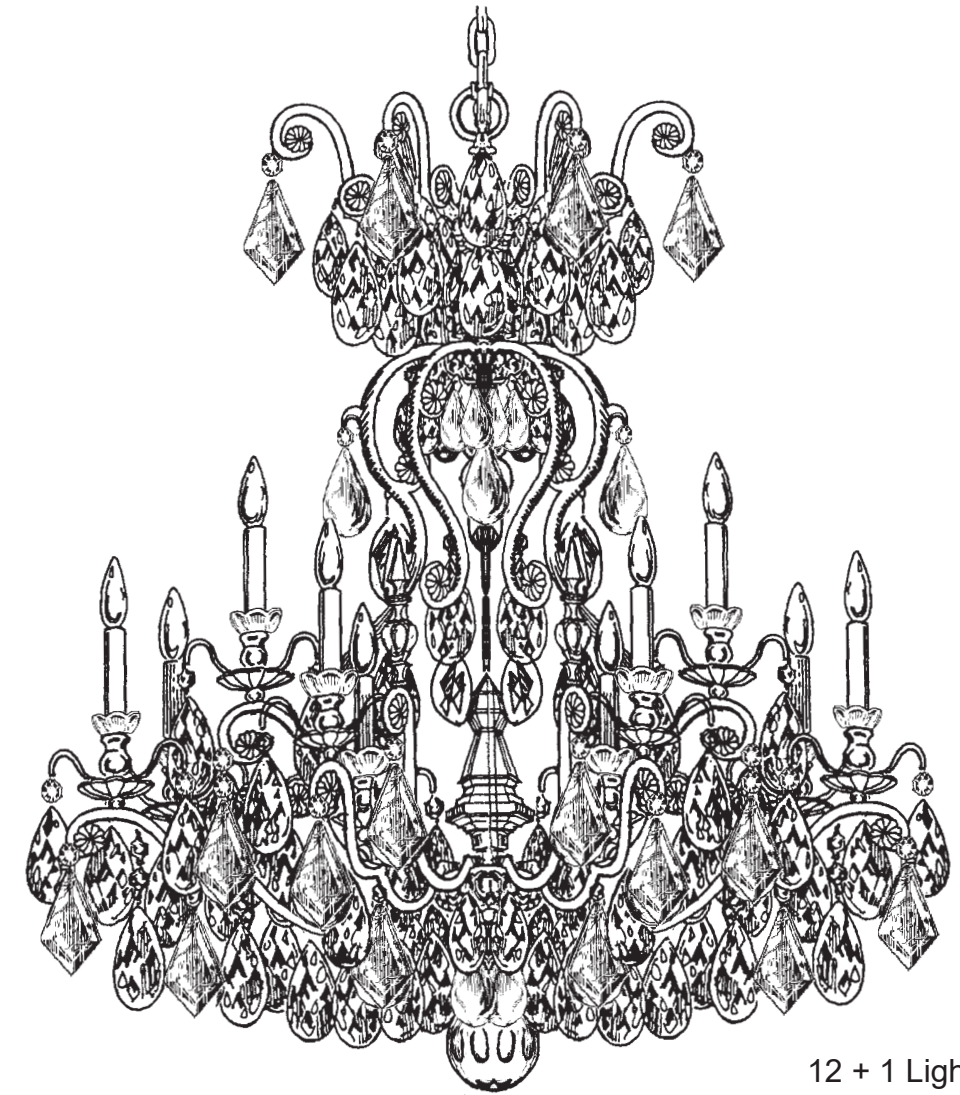











12 + 1 Lights  
Diameter: 32"  
Body Length: 40"  
Hanging Weight: 60 lbs.

**T**HIS DESIGN IS THE PROPRIETARY  
TRADE DRESS/TRADEMARK OF  
W SCHONBEK LLC.

 **SCHONBEK** | 1870

 **SCHONBEK** | 1870

								
MAX 60 W	MAX 15 W	110-120 V						

All electrical components must be installed by a licensed electrician in accordance with the National Electric Code and the appropriate local electrical codes.

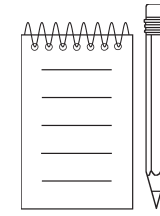
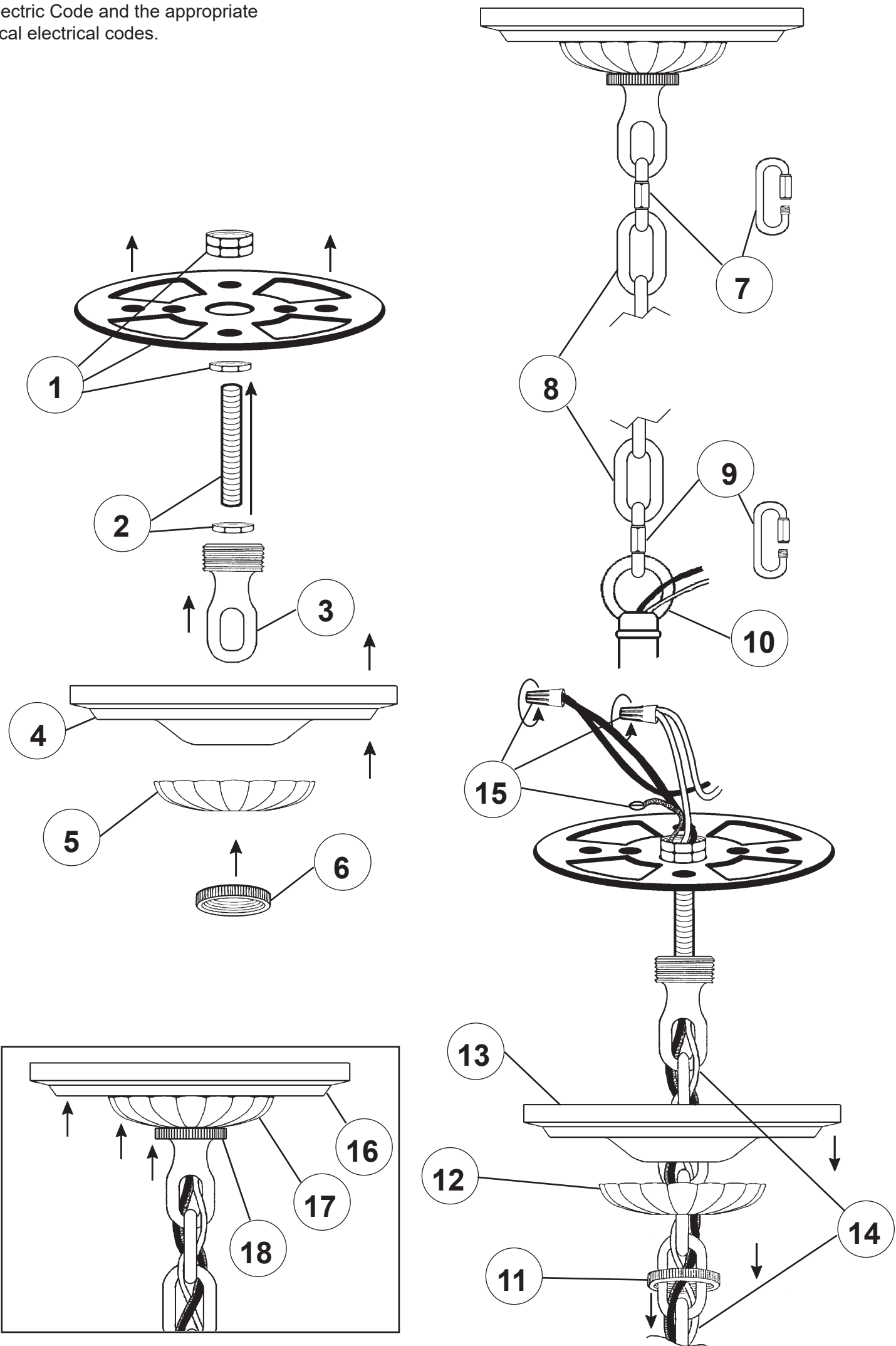

**Crystal Set 3 in Black**

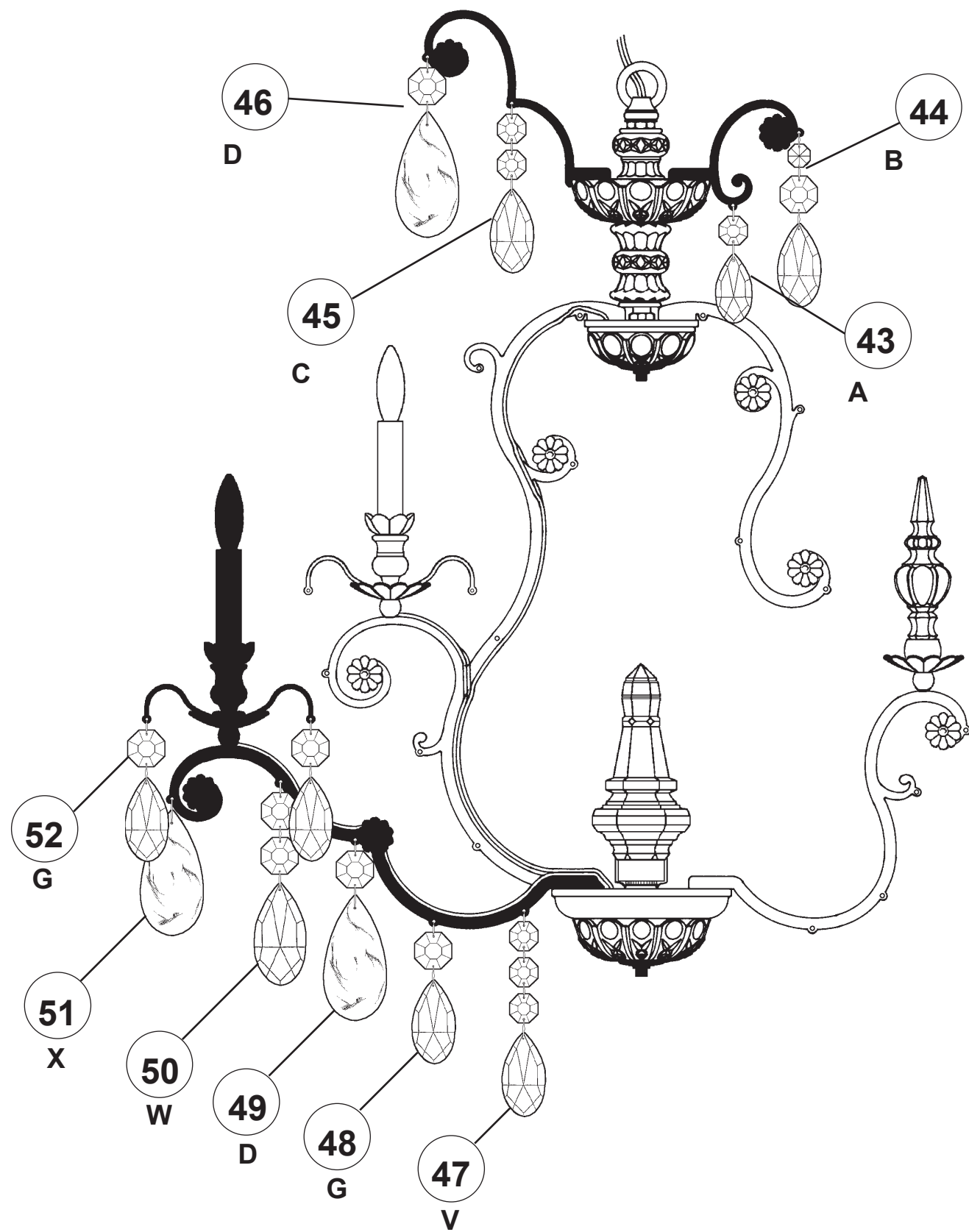

**SET 1**

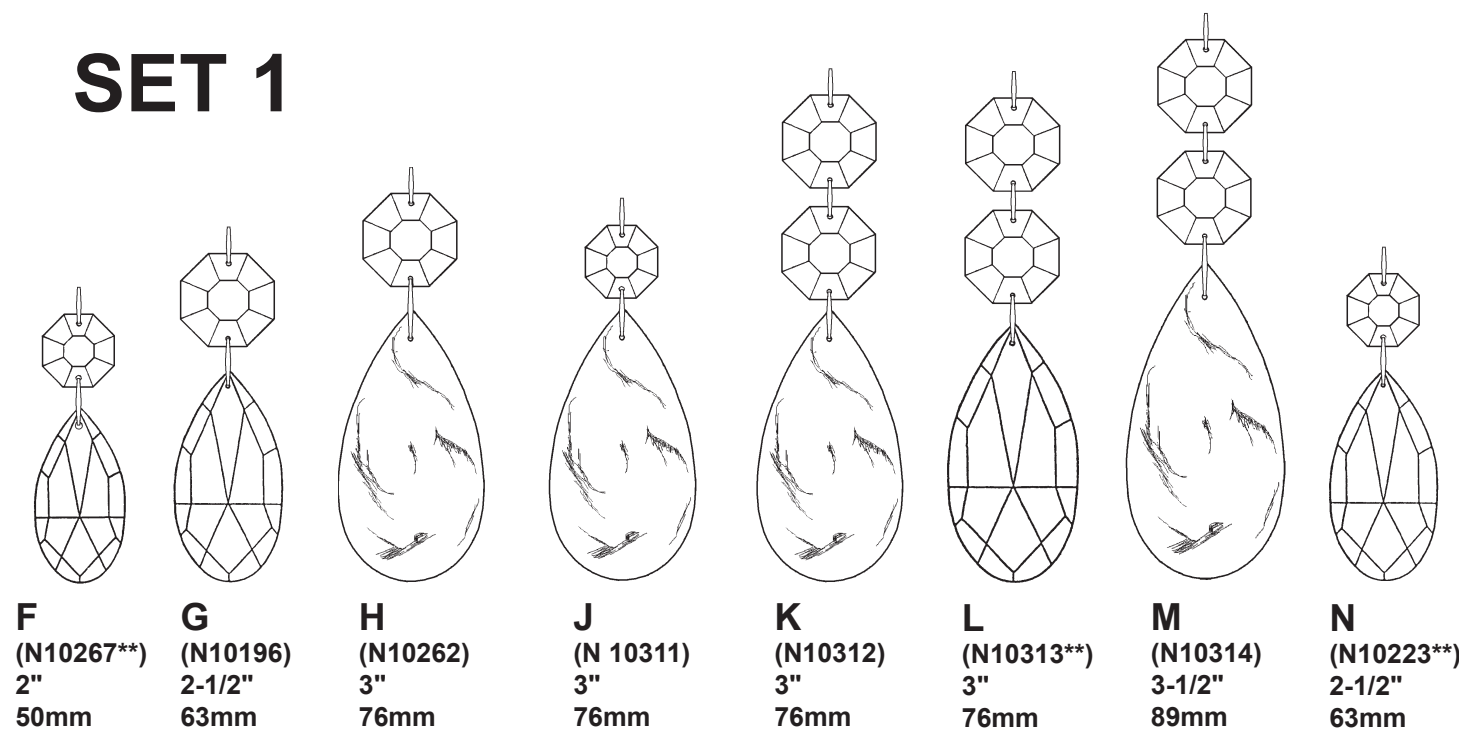

**SET 2**

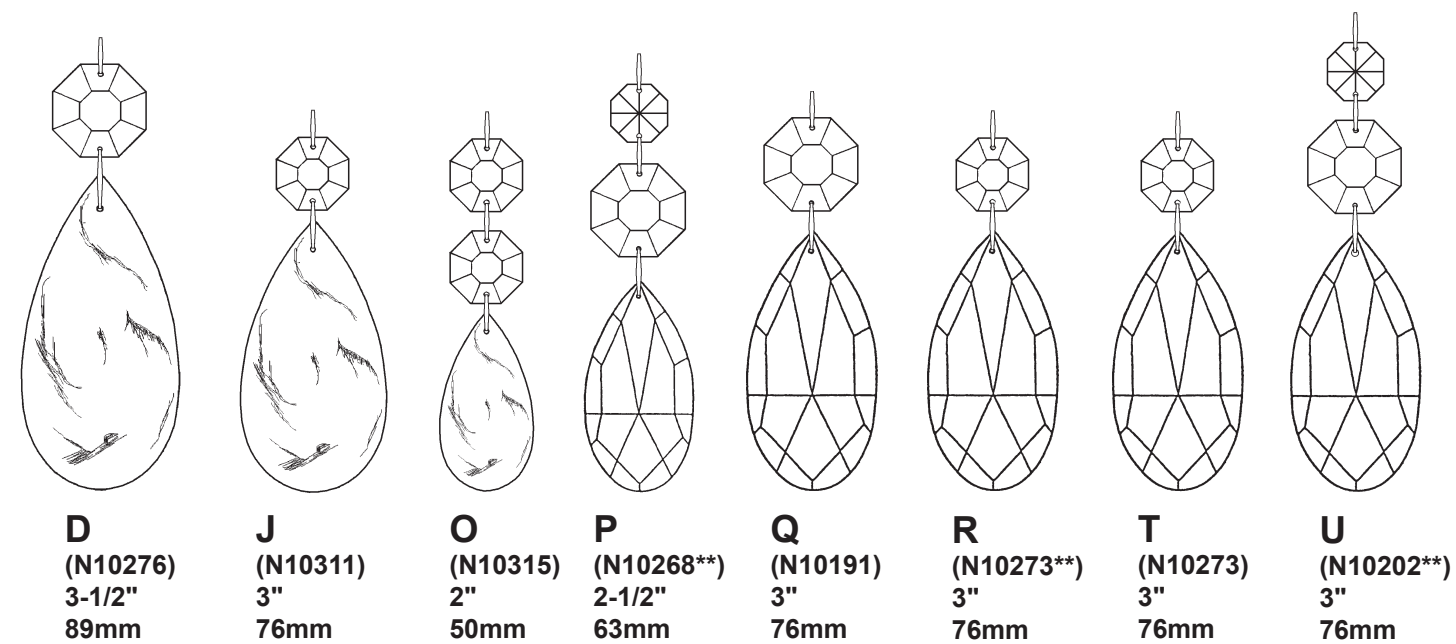

**SET 3**

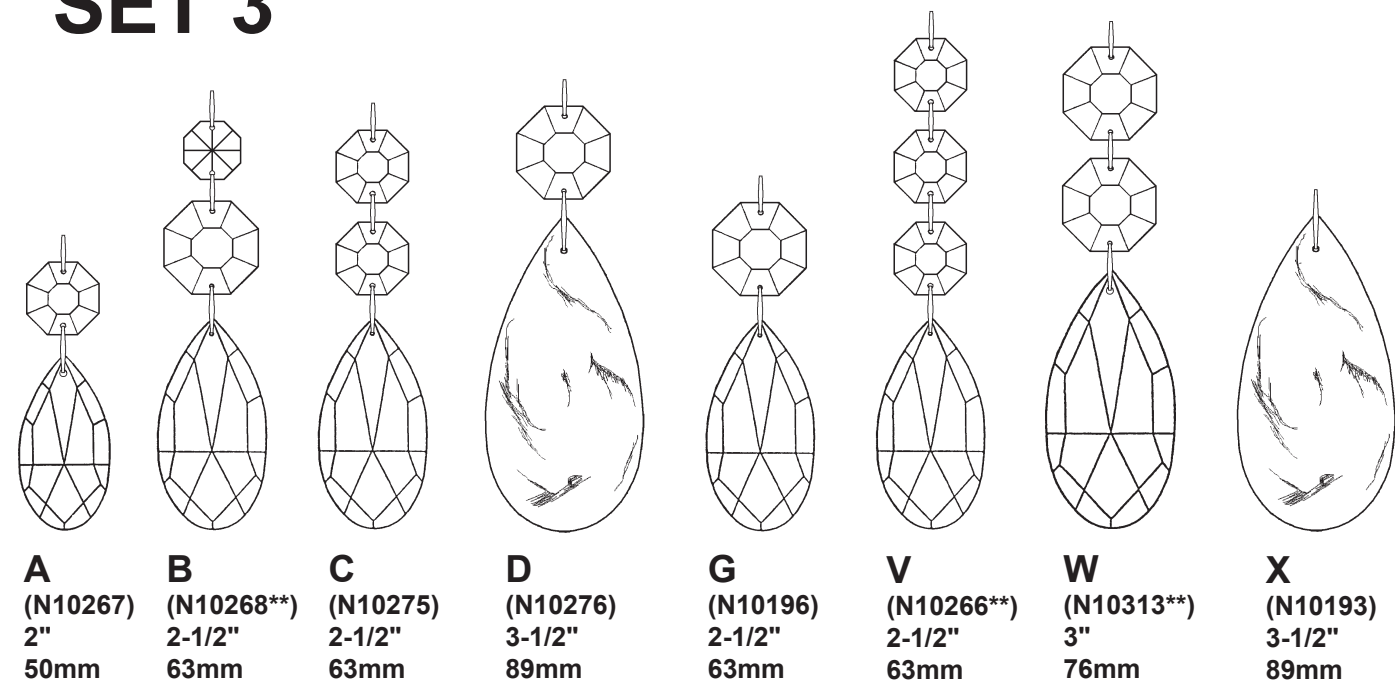

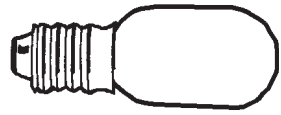

You will need 1 - T7  
15 Watts Max  
(Center Light)

20

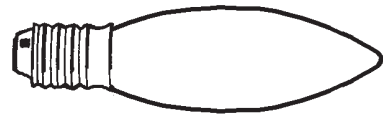

You will need 12 - B10  
25 Watts Recommended  
60 Watts Max

Install bulbs and be  
sure to test fixture  
BEFORE trimming.

**Crystal Set 1 in Black**

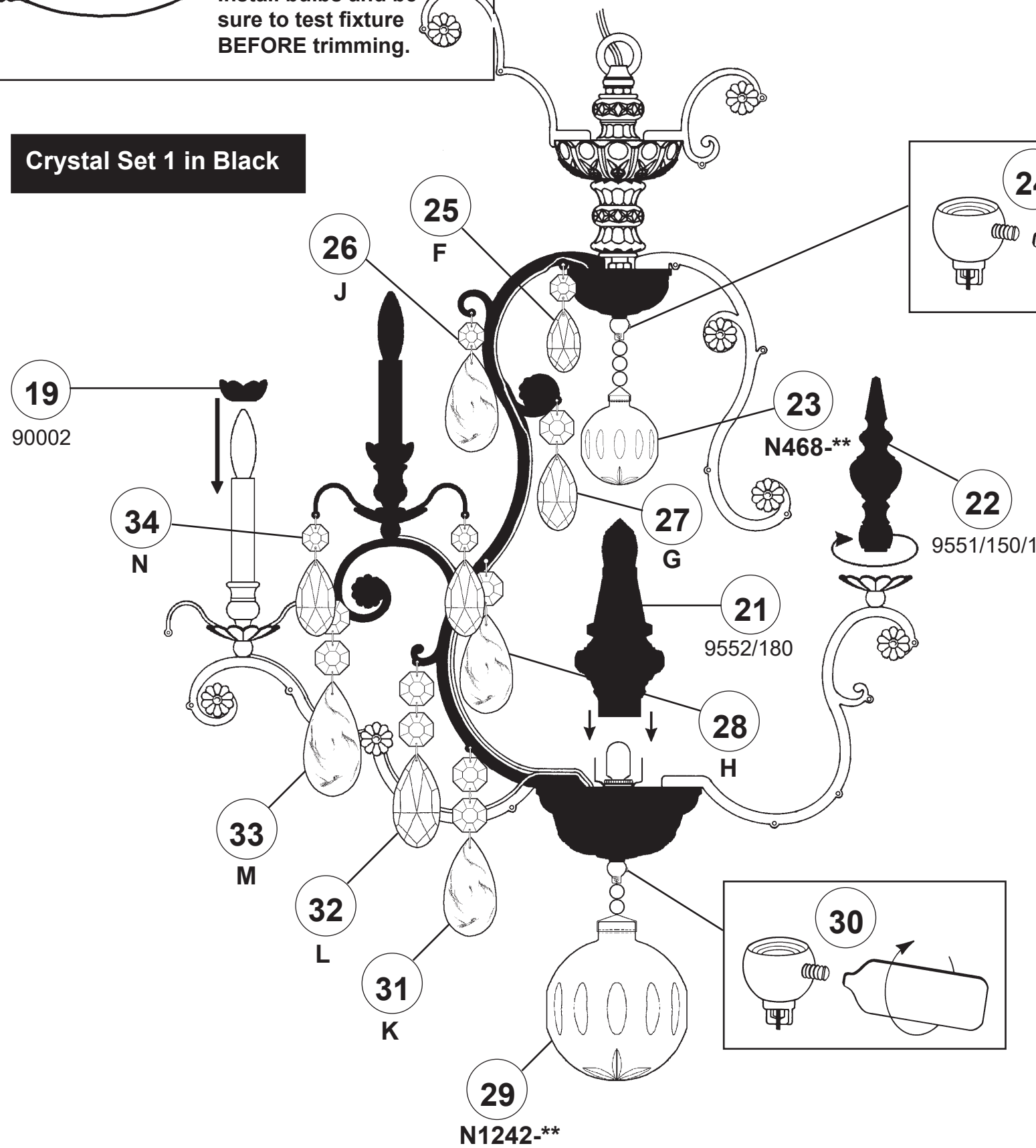

**Crystal Set 2 in Black**

