

RENAISSANCE 3584- _____

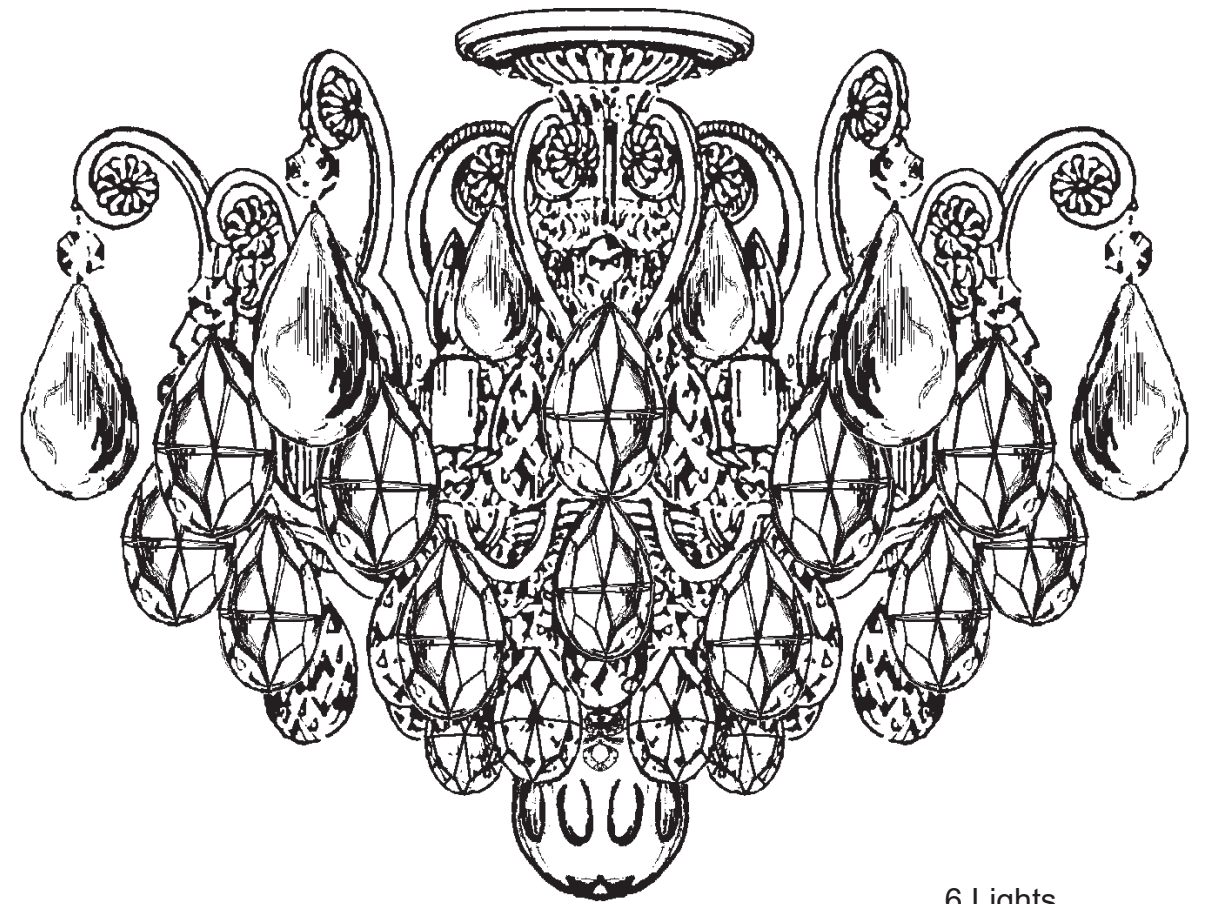











6 Lights
Diameter: 20"
Body Length: 15"
Hanging Weight: 18 lbs.

THIS DESIGN IS THE PROPRIETARY
TRADE DRESS/TRADEMARK OF
W SCHONBEK LLC.

 **SCHONBEK** | 1870

 **SCHONBEK** | 1870

								
MAX 40 W		110-120 V						

All electrical components must be installed by a licensed electrician in accordance with the National Electric Code and the appropriate local electrical codes.

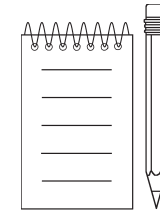
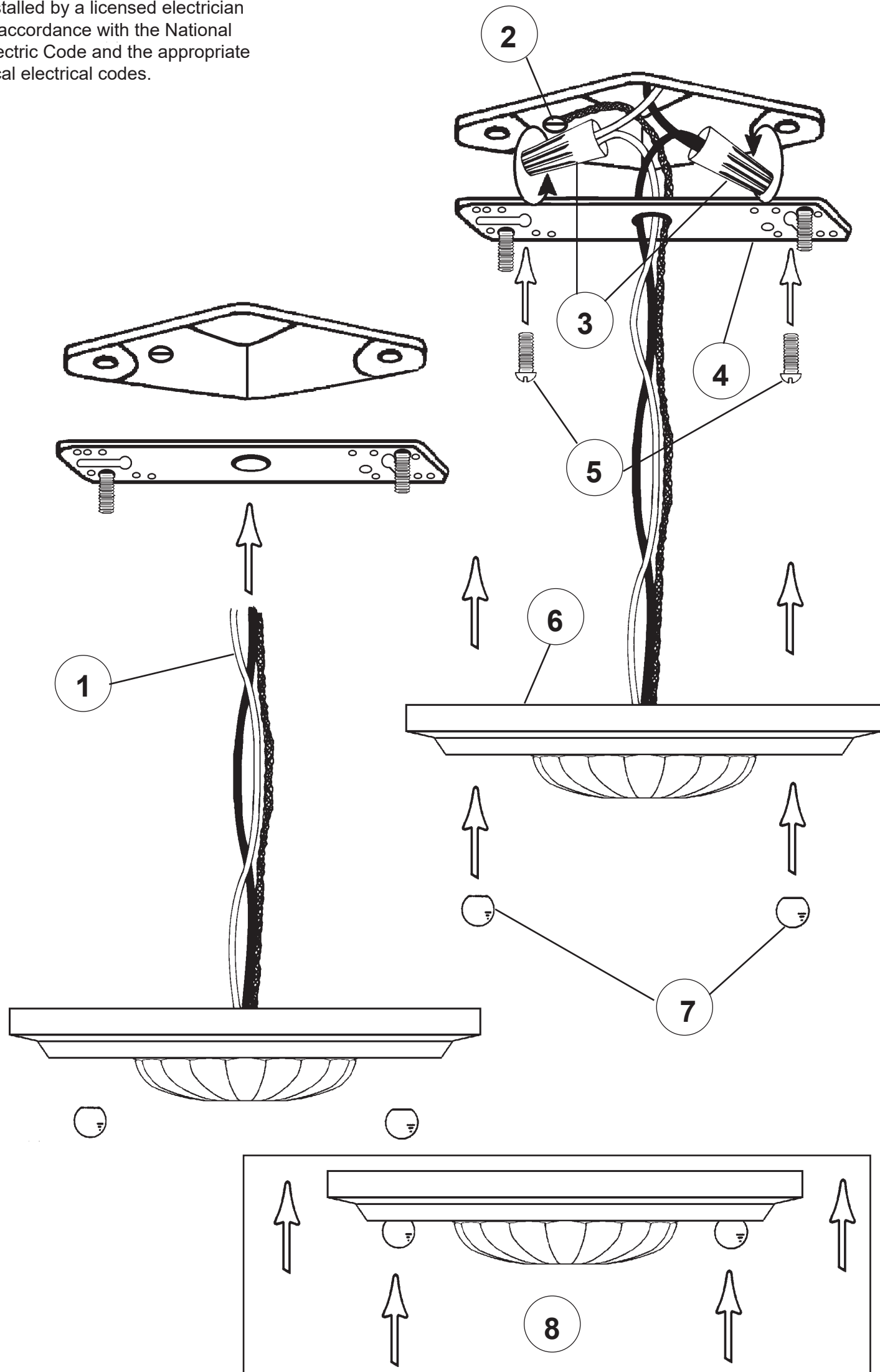



SET 1



A
(N3719**)
2"
50mm



B
(N3719)
2"
50mm

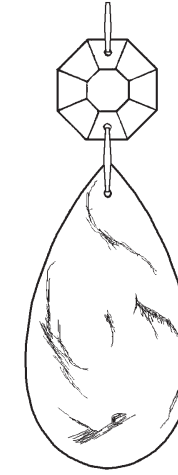

C
(N10272)
2-1/2"
63mm

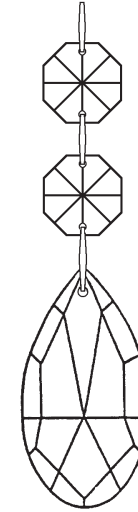

E
(N10277**)
2"
50mm

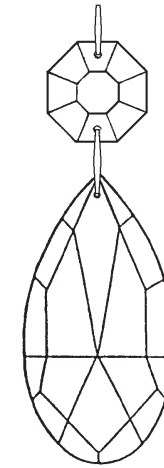

F
(N10223)
2-1/2"
63mm

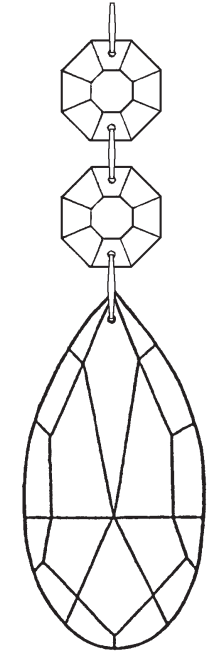

G
(N0000**)
3"
76mm

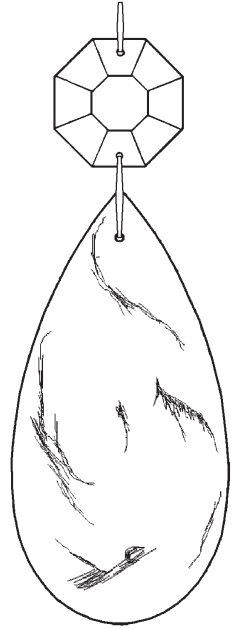

H
(N10276)
3-1/2"
89mm

SET 2

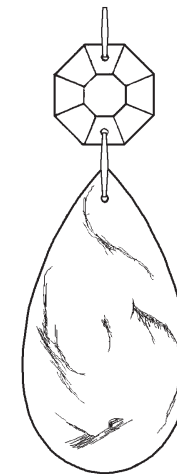

C
(N10272)
2-1/2"
63mm

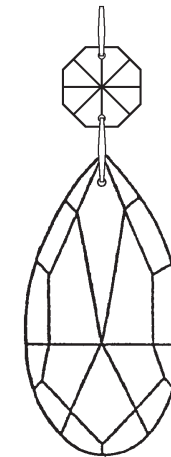

J
(N10221)
2-1/2"
63mm

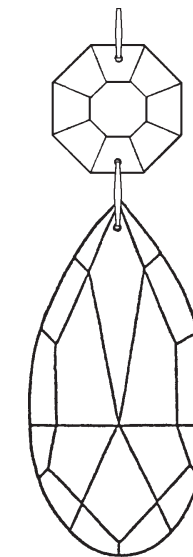

K
(N10191**)
3"
76mm

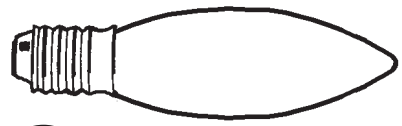

9 6 - B10
40 Watts Max
25 Watts Recommend

Crystal Set 1 in Black

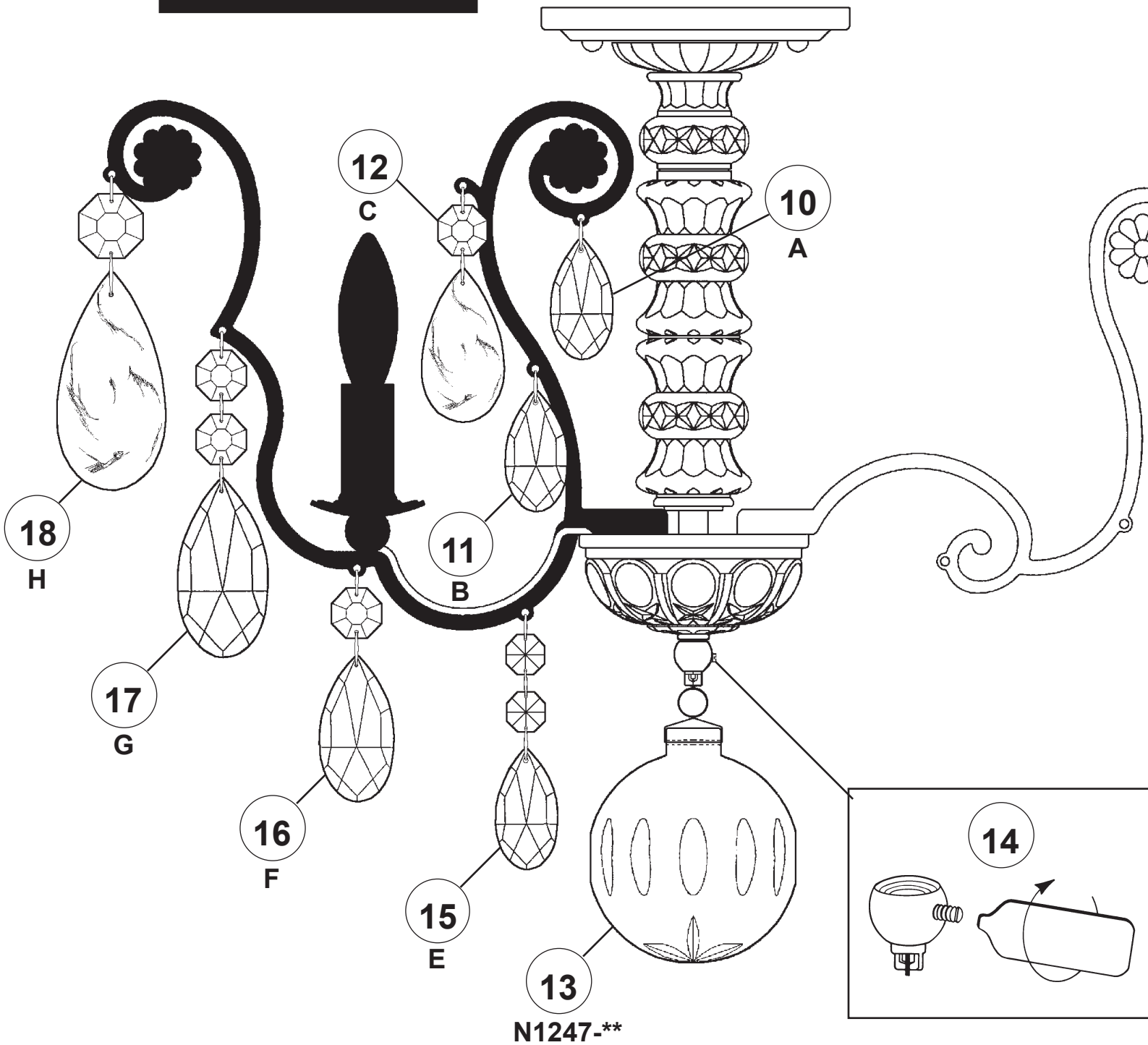

Crystal Set 2 in Black

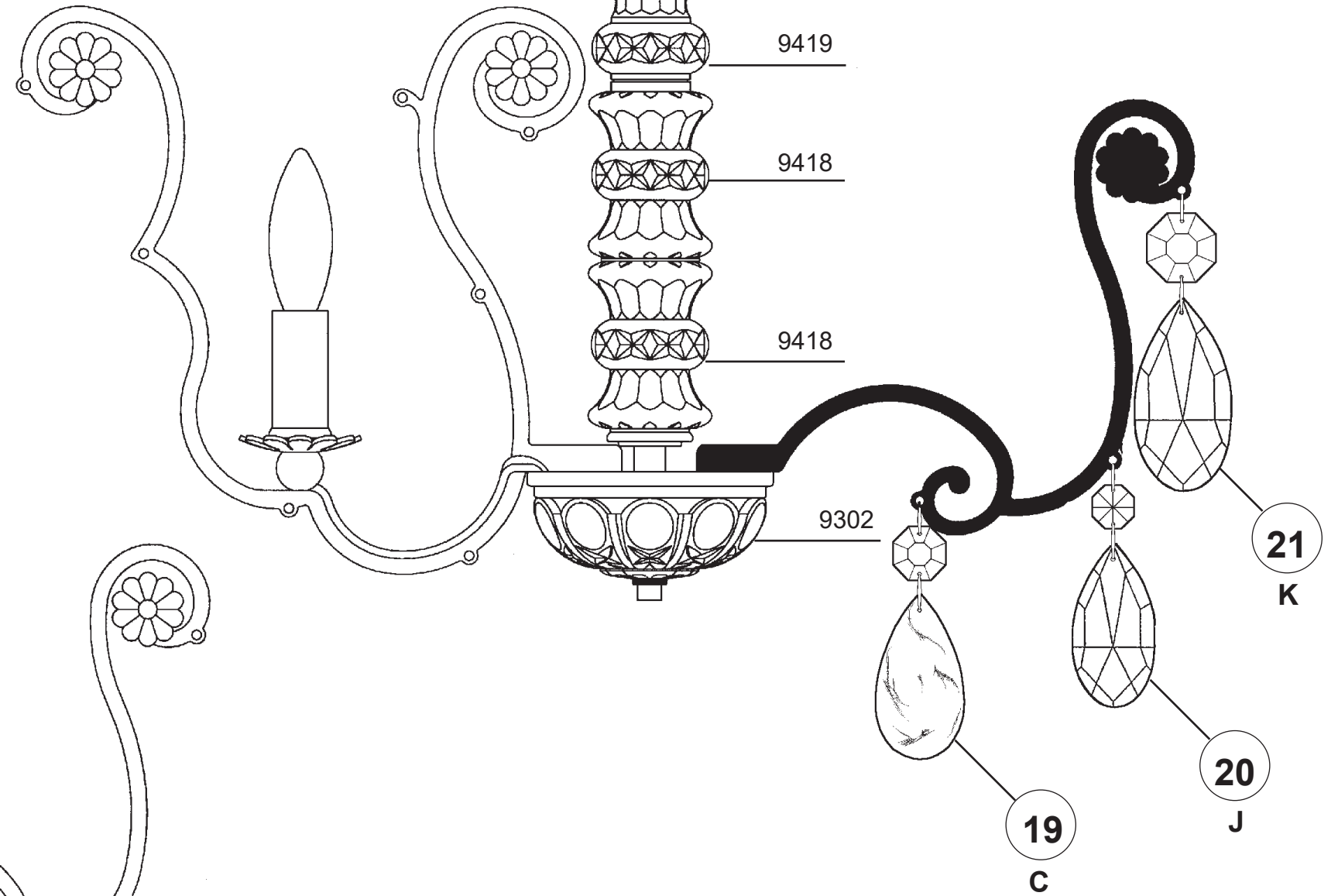

RENAISSANCE 3584- _____

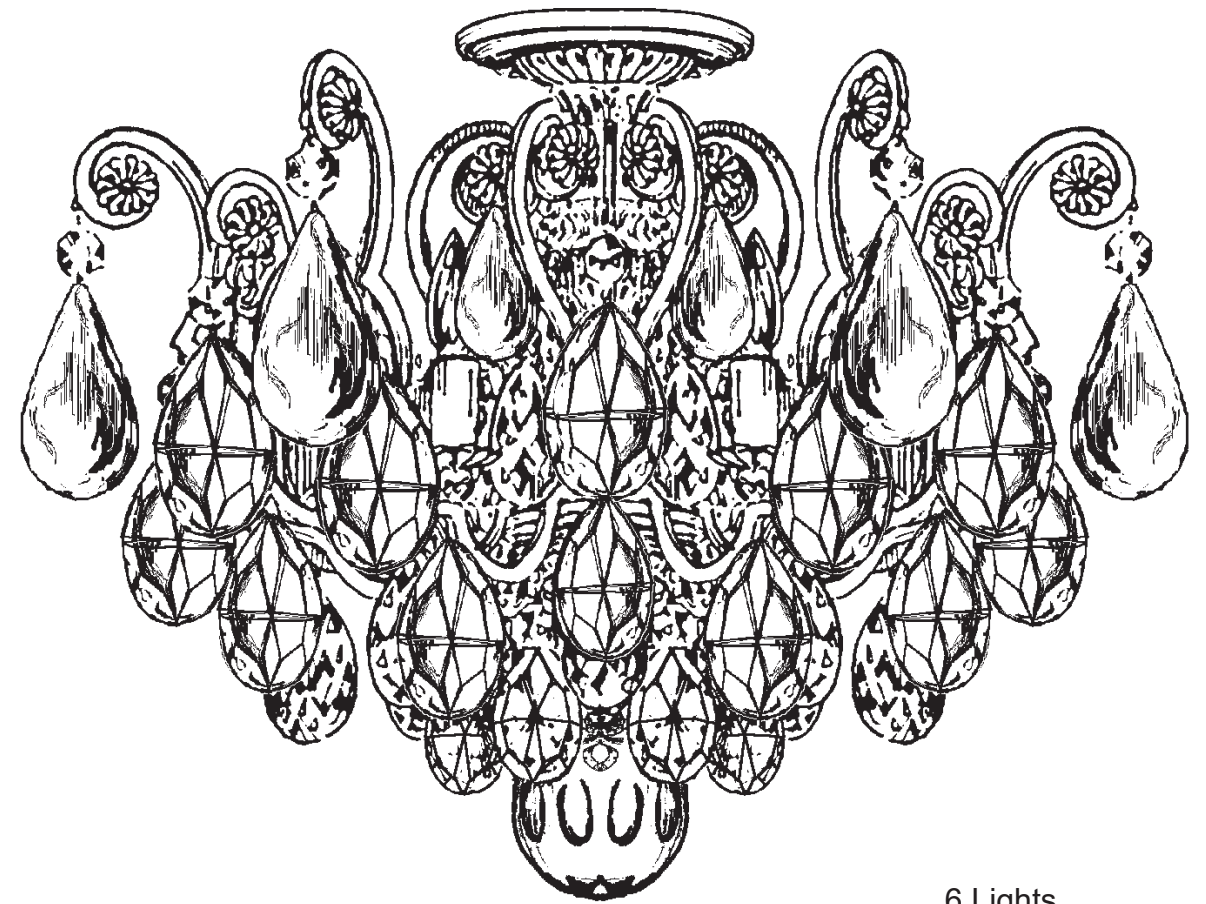











6 Lights
Diameter: 20"
Body Length: 15"
Hanging Weight: 18 lbs.

THIS DESIGN IS THE PROPRIETARY
TRADE DRESS/TRADEMARK OF
W SCHONBEK LLC.

 **SCHONBEK** | 1870

 **SCHONBEK** | 1870

								
MAX 40 W		110-120 V						

All electrical components must be installed by a licensed electrician in accordance with the National Electric Code and the appropriate local electrical codes.

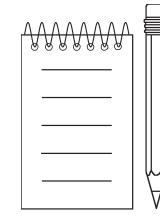
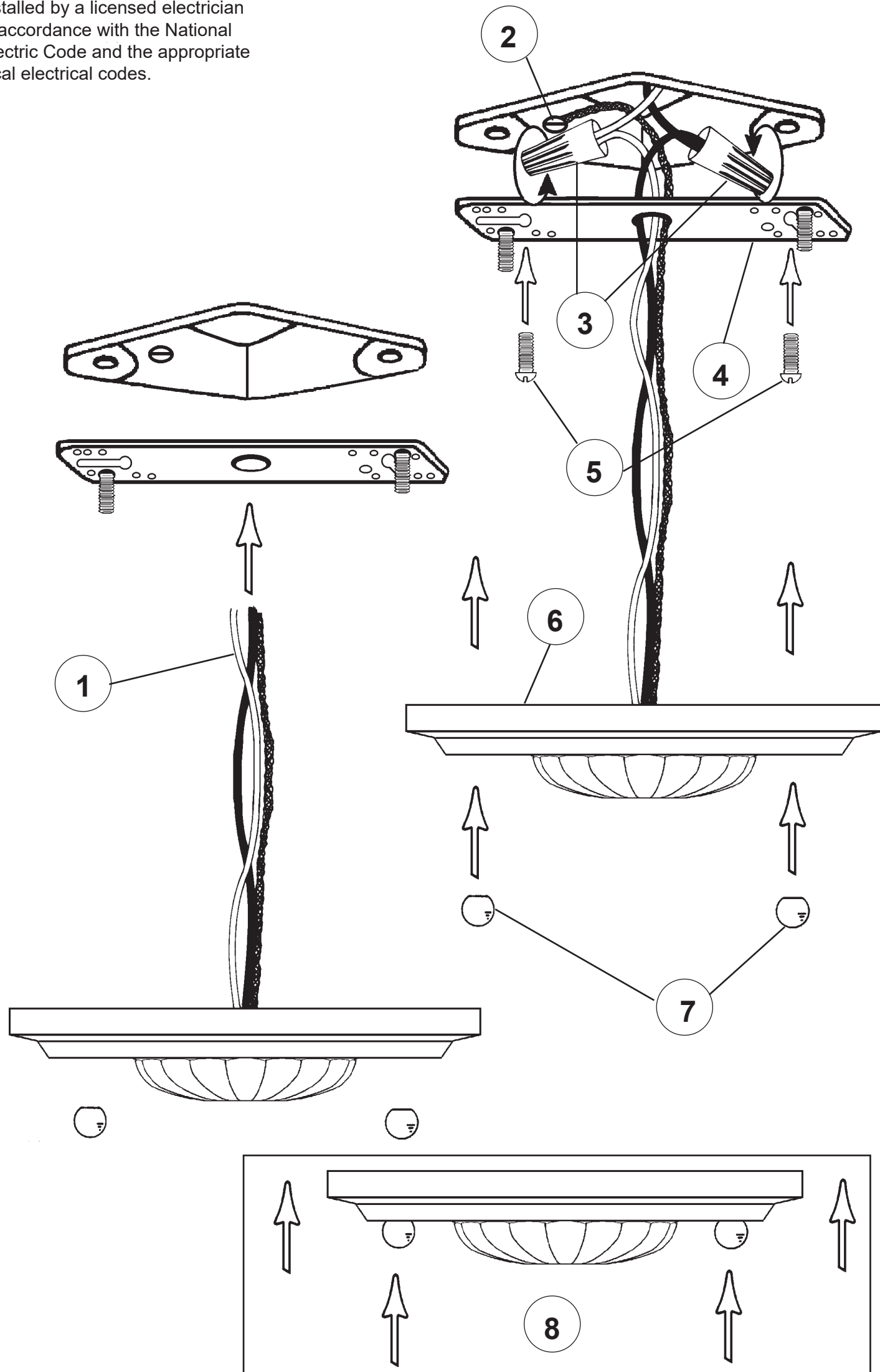

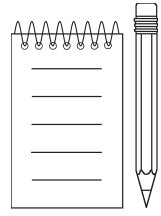

SET 1



A
(N3719**)
2"
50mm



B
(N3719)
2"
50mm

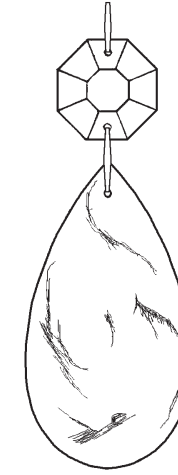

C
(N10272)
2-1/2"
63mm

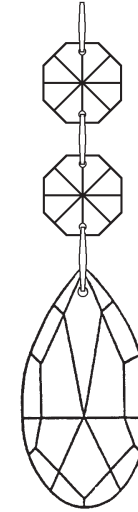

E
(N10277**)
2"
50mm



F
(N10223)
2-1/2"
63mm

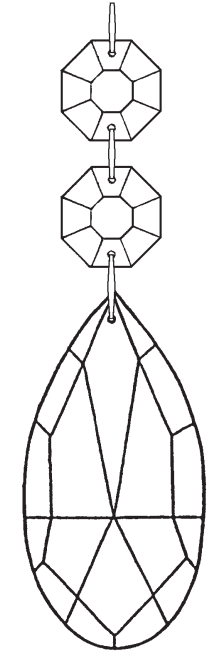

G
(N0000**)
3"
76mm

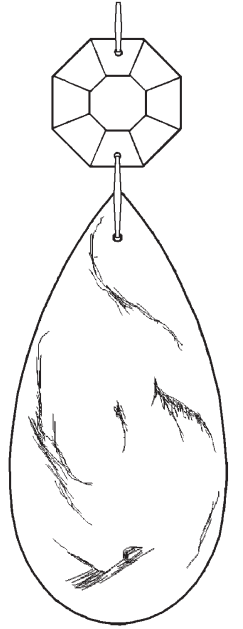

H
(N10276)
3-1/2"
89mm

SET 2

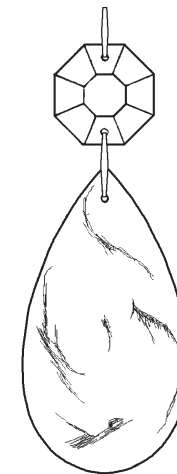

C
(N10272)
2-1/2"
63mm

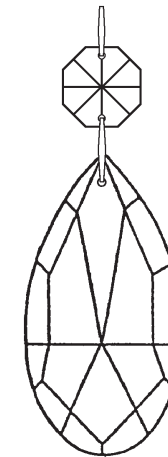

J
(N10221)
2-1/2"
63mm

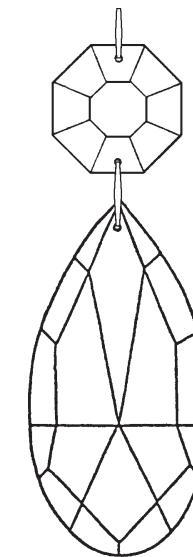

K
(N10191**)
3"
76mm

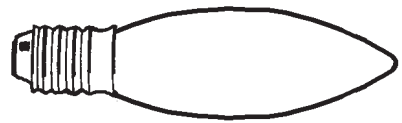

9 6 - B10
40 Watts Max
25 Watts Recommend

Crystal Set 1 in Black

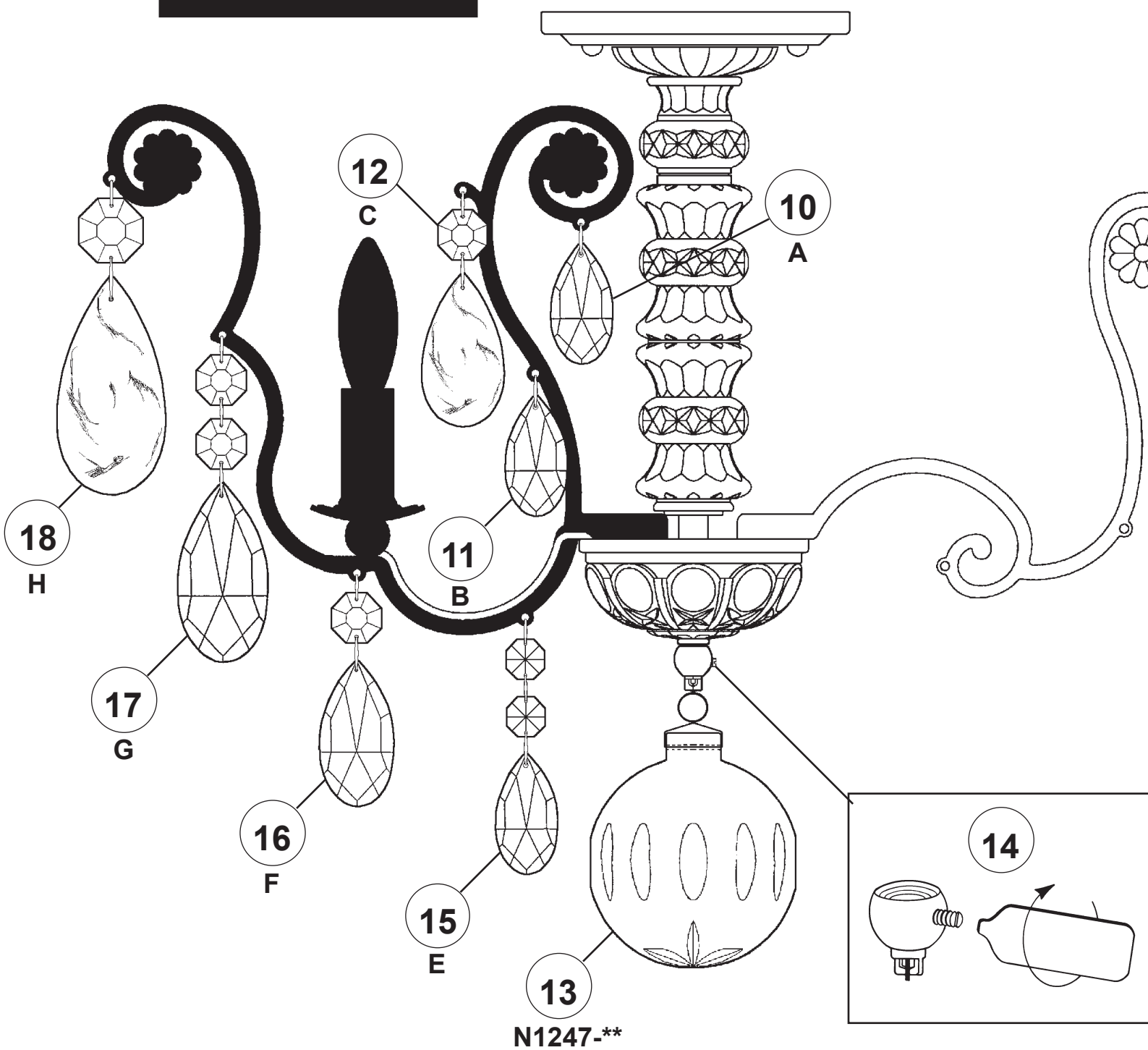

Crystal Set 2 in Black

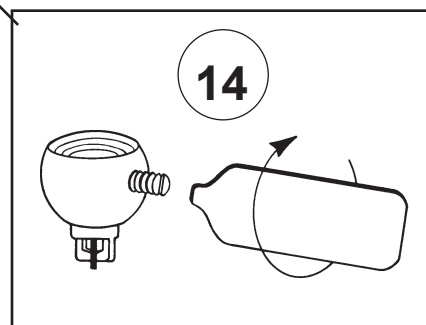
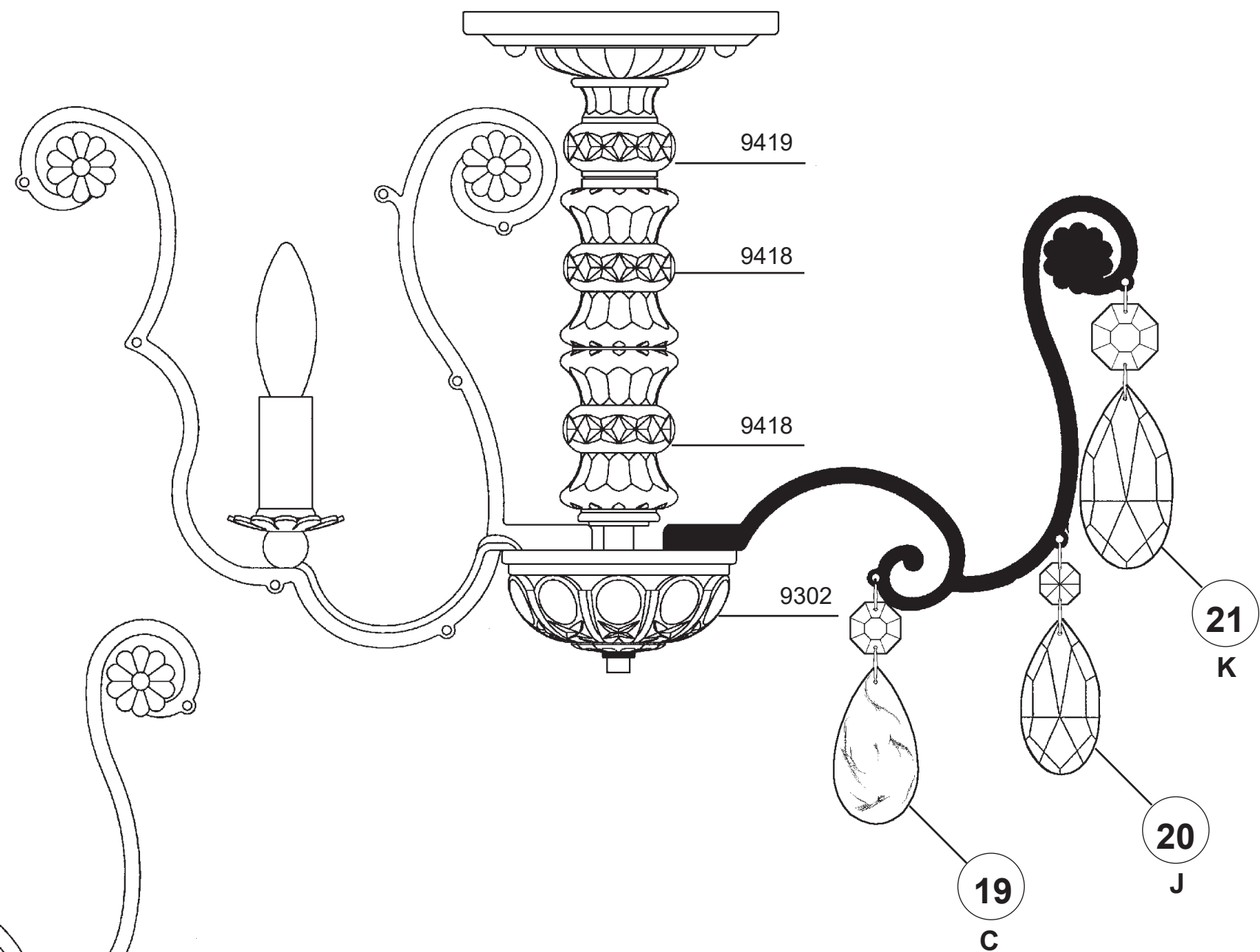

RENAISSANCE 3584- _____

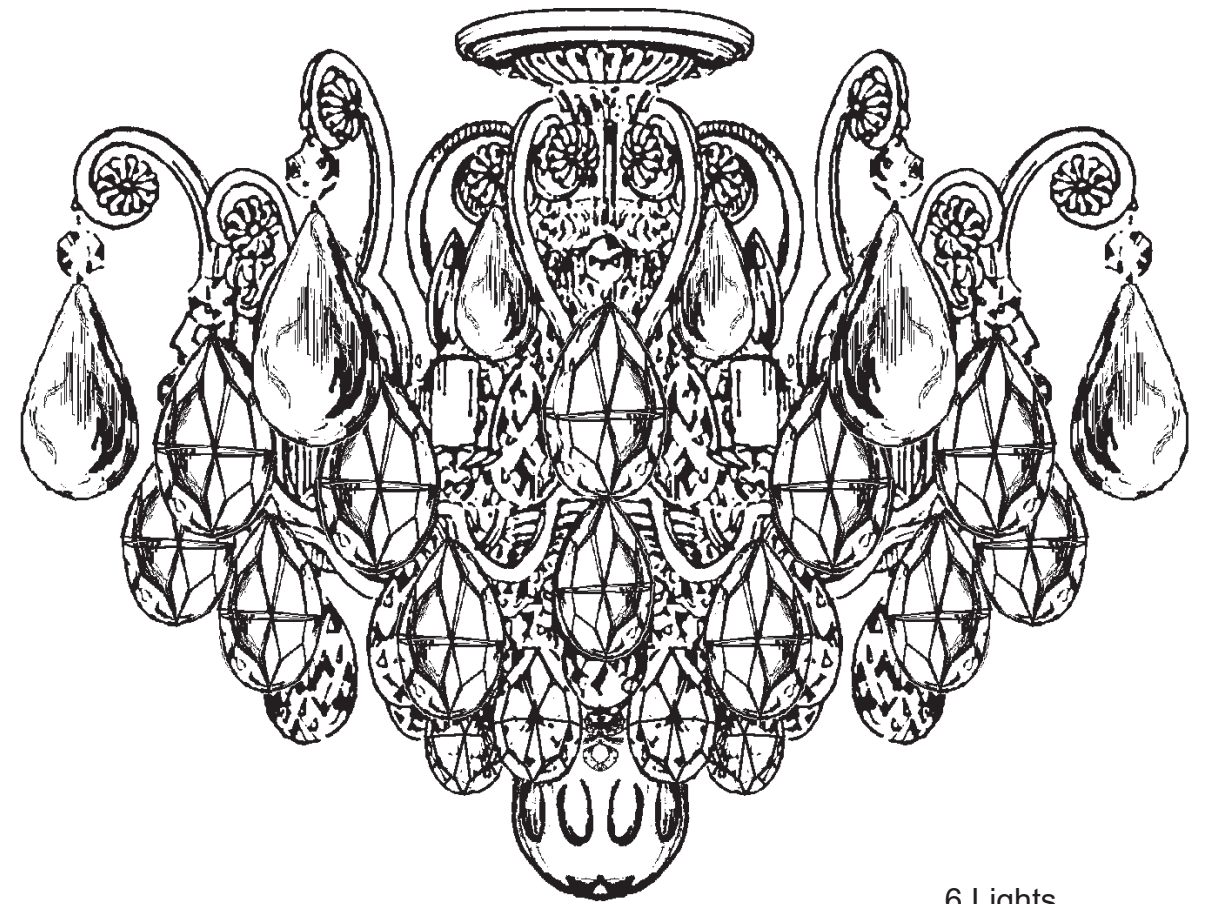











6 Lights
Diameter: 20"
Body Length: 15"
Hanging Weight: 18 lbs.

THIS DESIGN IS THE PROPRIETARY
TRADE DRESS/TRADEMARK OF
W SCHONBEK LLC.

 **SCHONBEK** | 1870

 **SCHONBEK** | 1870

								
MAX 40 W		110-120 V						

All electrical components must be installed by a licensed electrician in accordance with the National Electric Code and the appropriate local electrical codes.

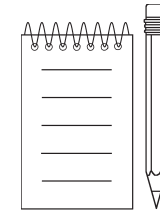
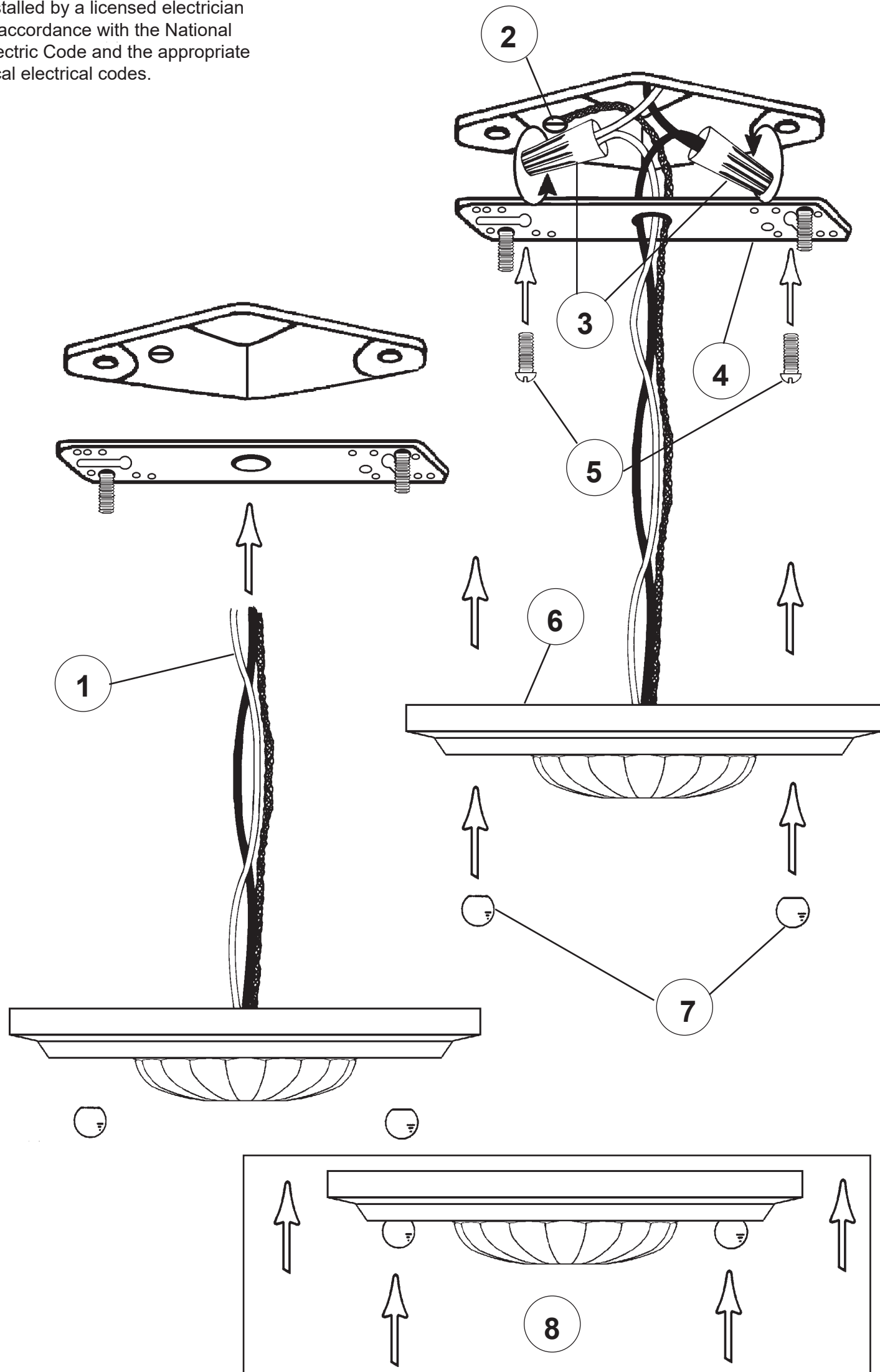



SET 1



A
(N3719**)
2"
50mm



B
(N3719)
2"
50mm

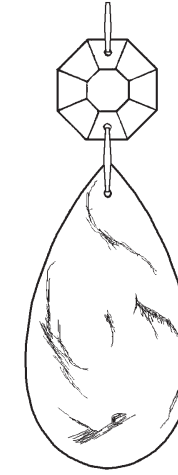

C
(N10272)
2-1/2"
63mm

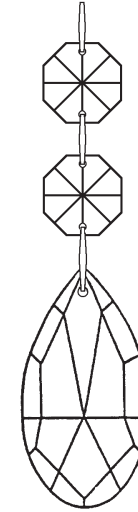

E
(N10277**)
2"
50mm



F
(N10223)
2-1/2"
63mm

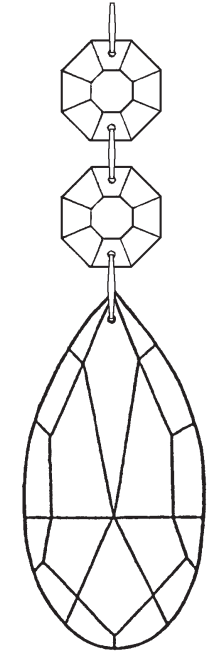

G
(N0000**)
3"
76mm

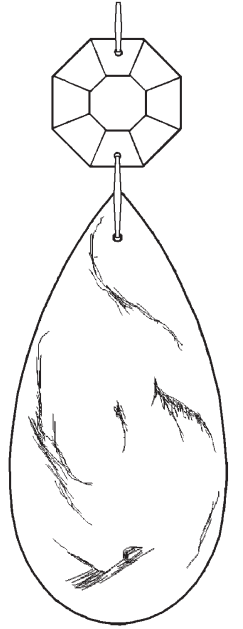

H
(N10276)
3-1/2"
89mm

SET 2

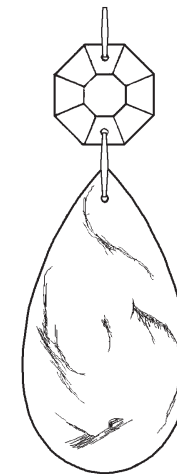

C
(N10272)
2-1/2"
63mm

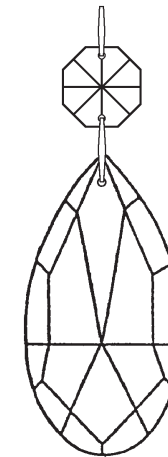

J
(N10221)
2-1/2"
63mm

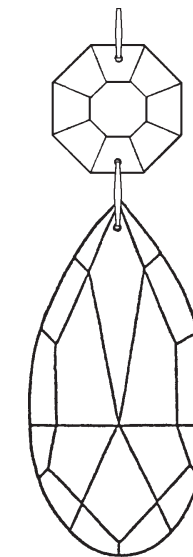

K
(N10191**)
3"
76mm

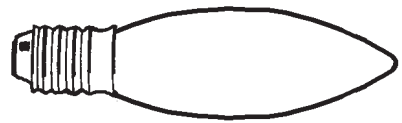

9 6 - B10
40 Watts Max
25 Watts Recommend

Crystal Set 1 in Black

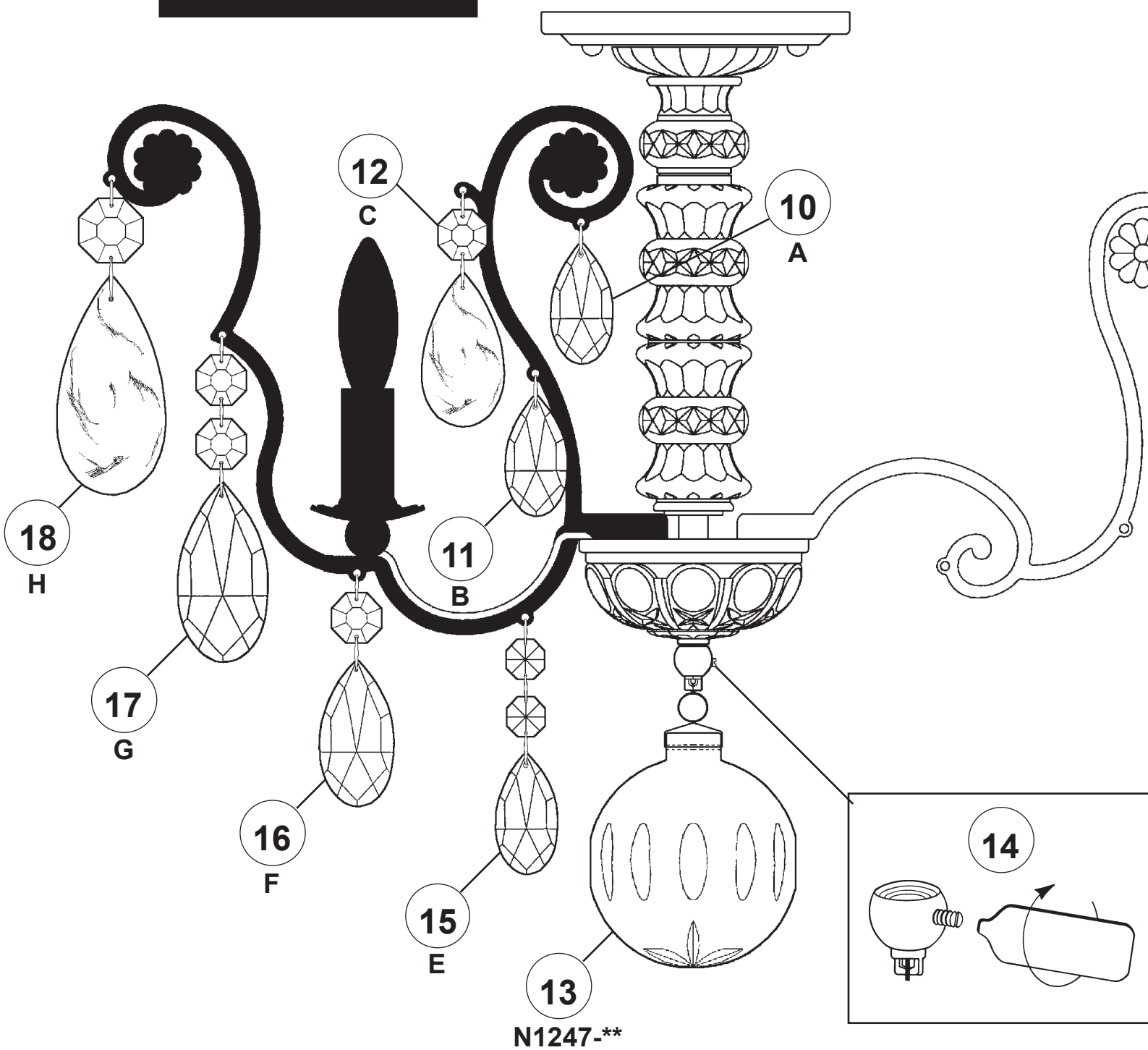

Crystal Set 2 in Black

