

NEW ORLEANS 3650- ___ __H

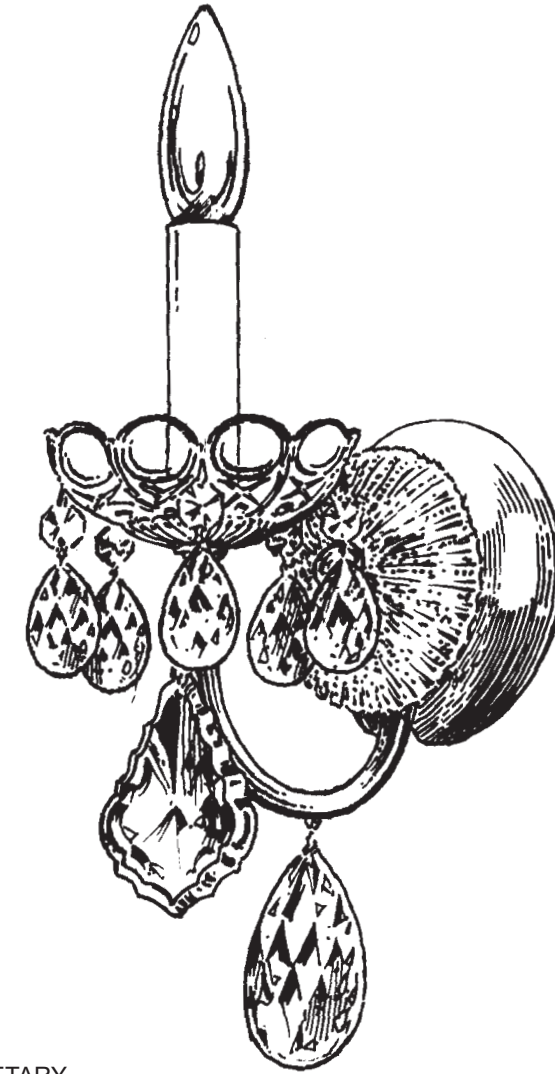

1 Light
Diameter: 4-1/2"
Body Length: 13"
Extension: 6"
Hanging Weight: 2 lbs.

THIS DESIGN IS THE PROPRIETARY
TRADE DRESS/TRADEMARK OF
W SCHONBEK LLC.

 **SCHONBEK** | 1870

 **SCHONBEK** | 1870

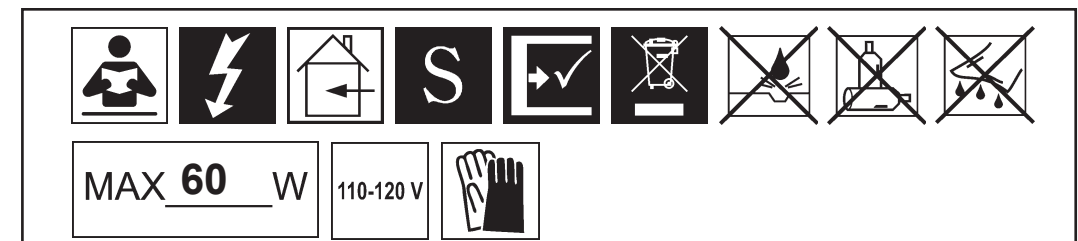

All electrical components must be installed by a licensed electrician in accordance with the National Electric Code and the appropriate local electrical codes.

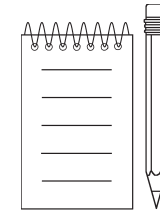
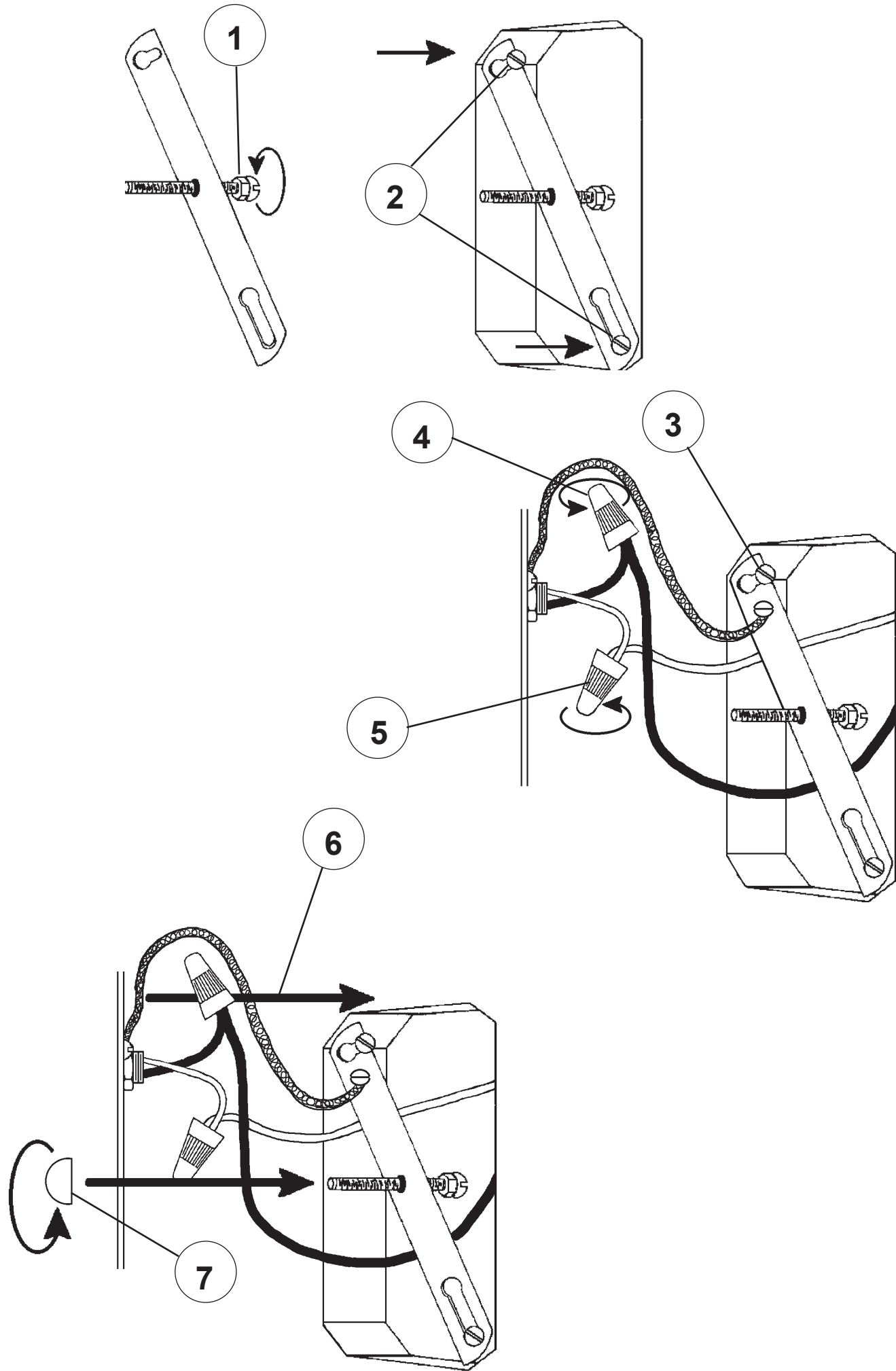



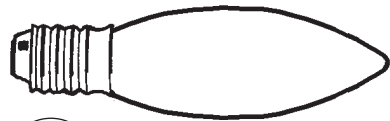

8

You will need 1 - B10
25 Watts Recommended
60 Watts Max

**Install bulb and be sure
to test fixture BEFORE
trimming.**

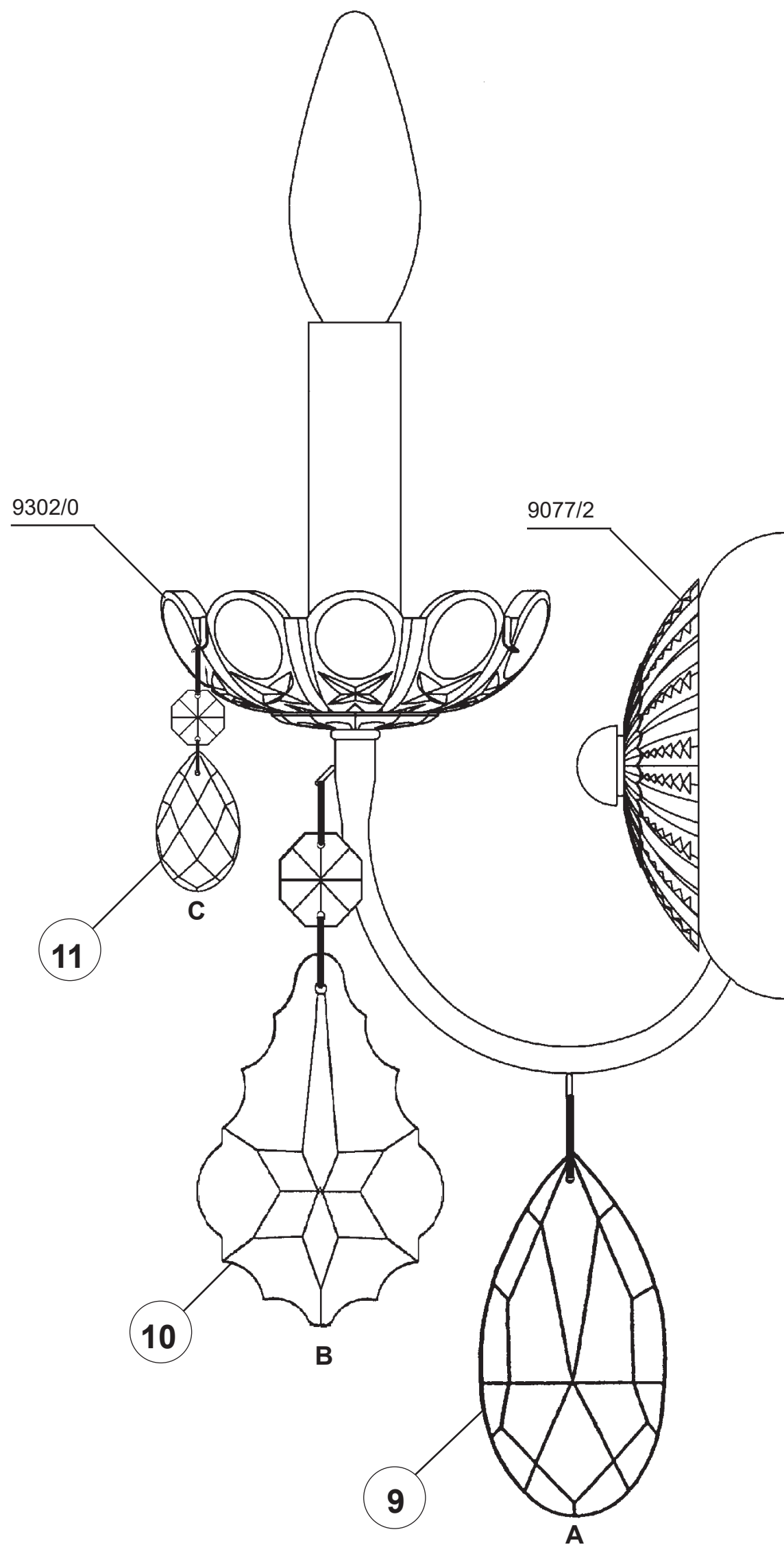

NEW ORLEANS 3650-__ __R

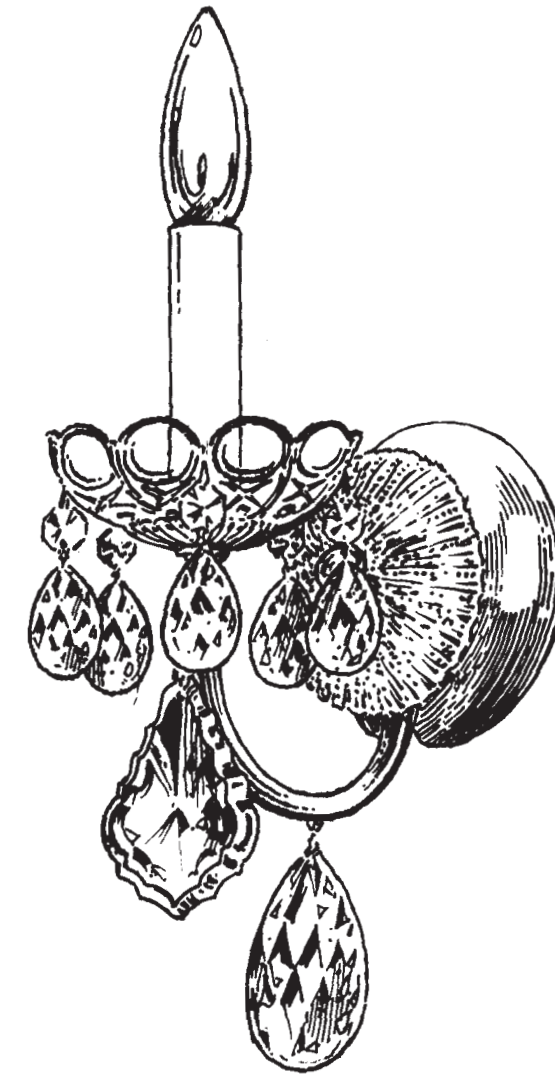











1 Light
Diameter: 4-1/2"
Body Length: 13"
Extension: 6"
Hanging Weight: 2 lbs.

THIS DESIGN IS THE PROPRIETARY
TRADE DRESS/TRADEMARK OF
W SCHONBEK LLC.

 **SCHONBEK** | 1870

 **SCHONBEK** | 1870

								
MAX 60 W		110-120 V						

All electrical components must be installed by a licensed electrician in accordance with the National Electric Code and the appropriate local electrical codes.

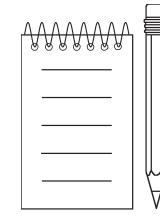
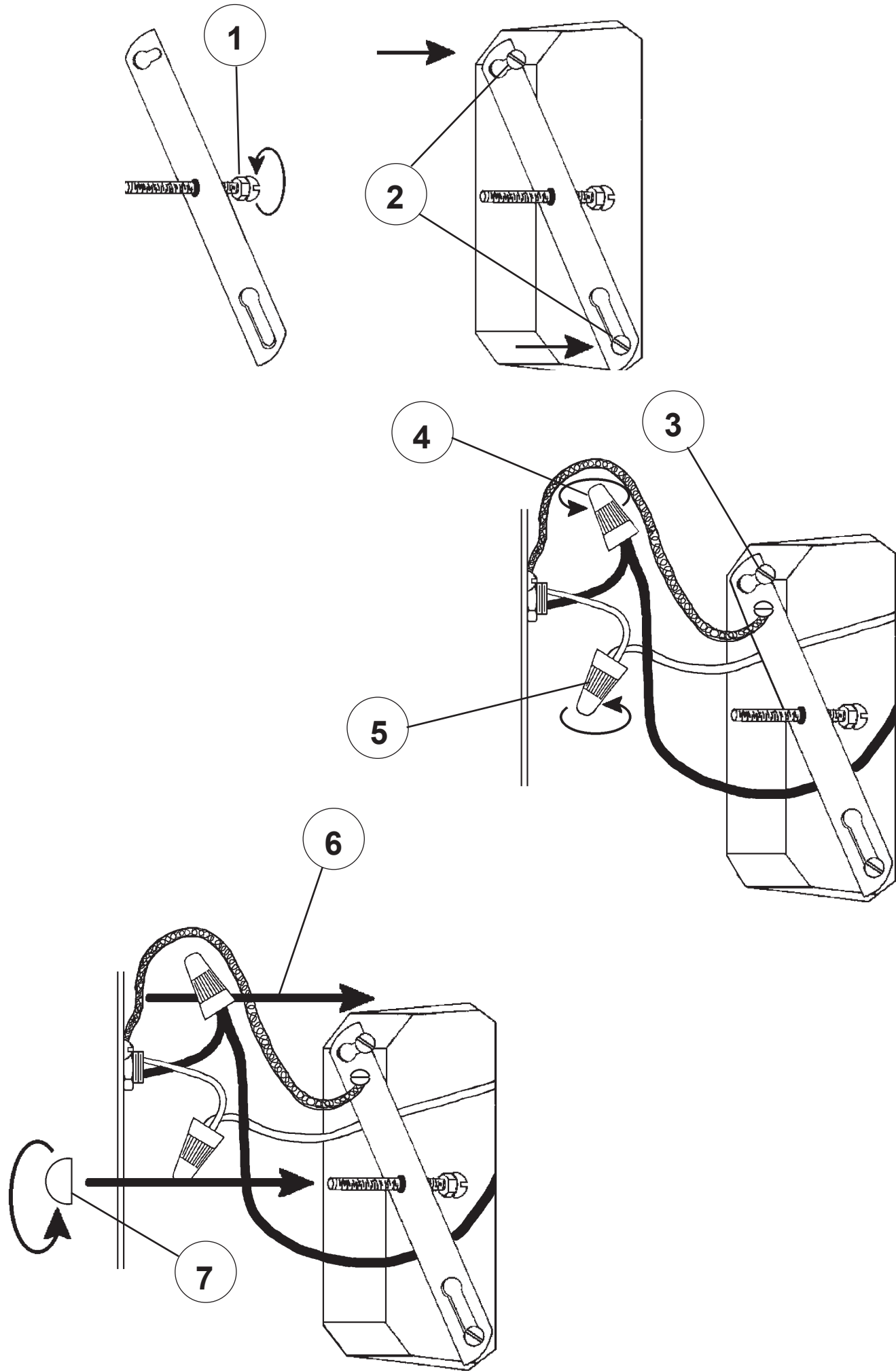

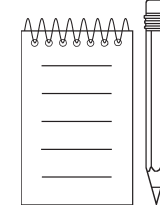
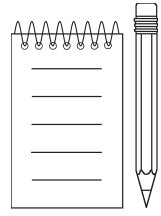

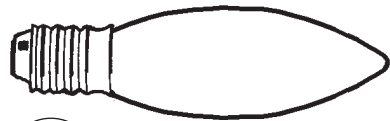

8

You will need 1 - B10
25 Watts Recommended
60 Watts Max

Install bulb and be sure
to test fixture **BEFORE**
trimming.

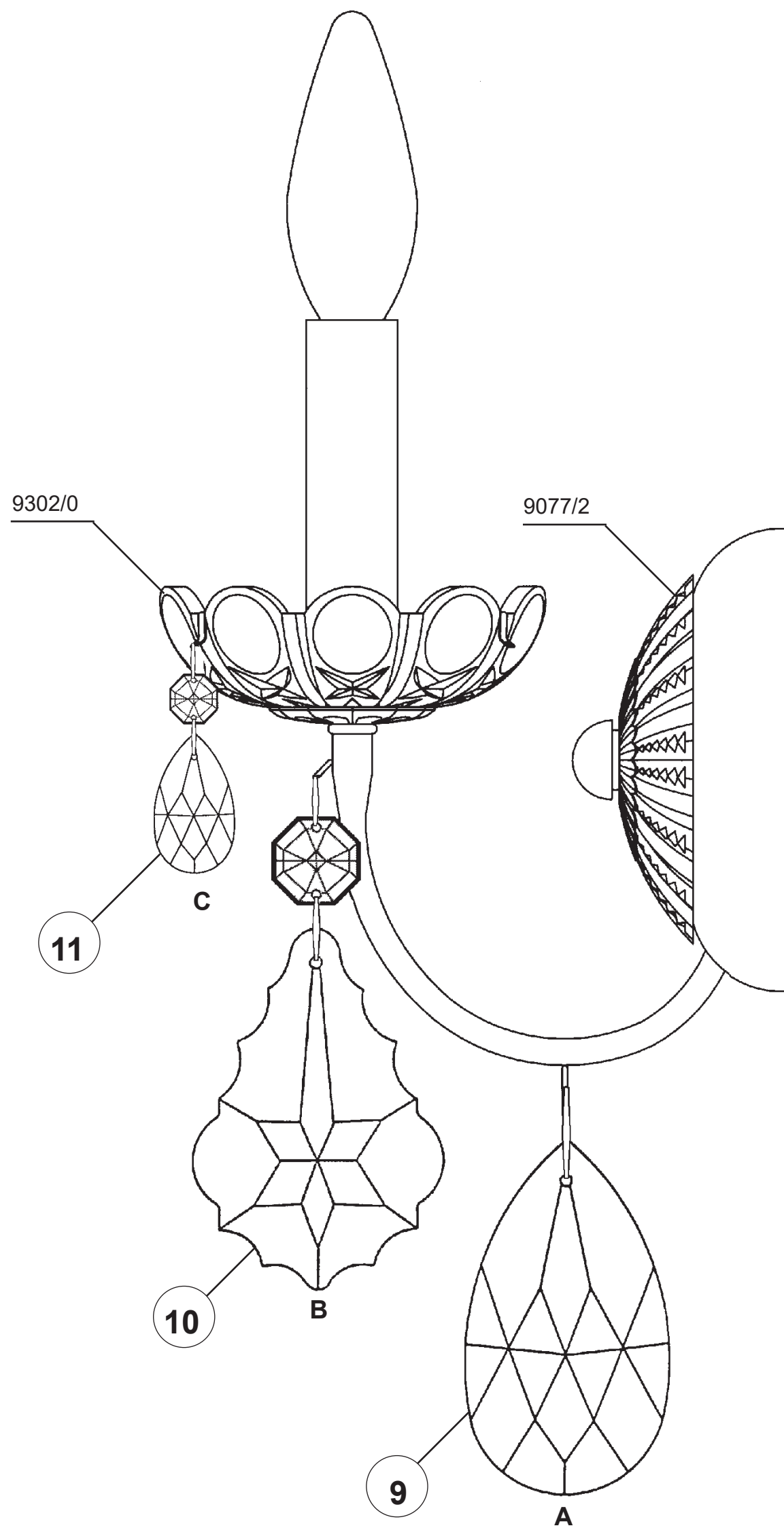

NEW ORLEANS 3650- ___ _S

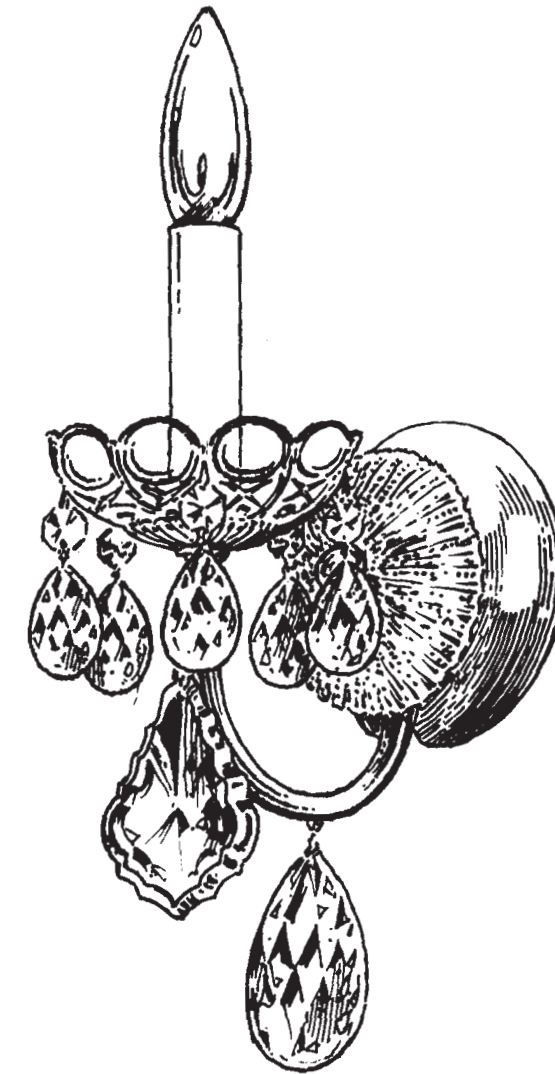











1 Light
Diameter: 4-1/2"
Body Length: 13"
Extension: 6"
Hanging Weight: 2 lbs.

THIS DESIGN IS THE PROPRIETARY
TRADE DRESS/TRADEMARK OF
W SCHONBEK LLC.

 **SCHONBEK** | 1870

 **SCHONBEK** | 1870

								
MAX 60 W	110-120 V							

All electrical components must be installed by a licensed electrician in accordance with the National Electric Code and the appropriate local electrical codes.

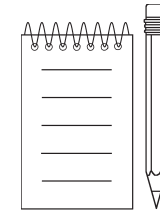
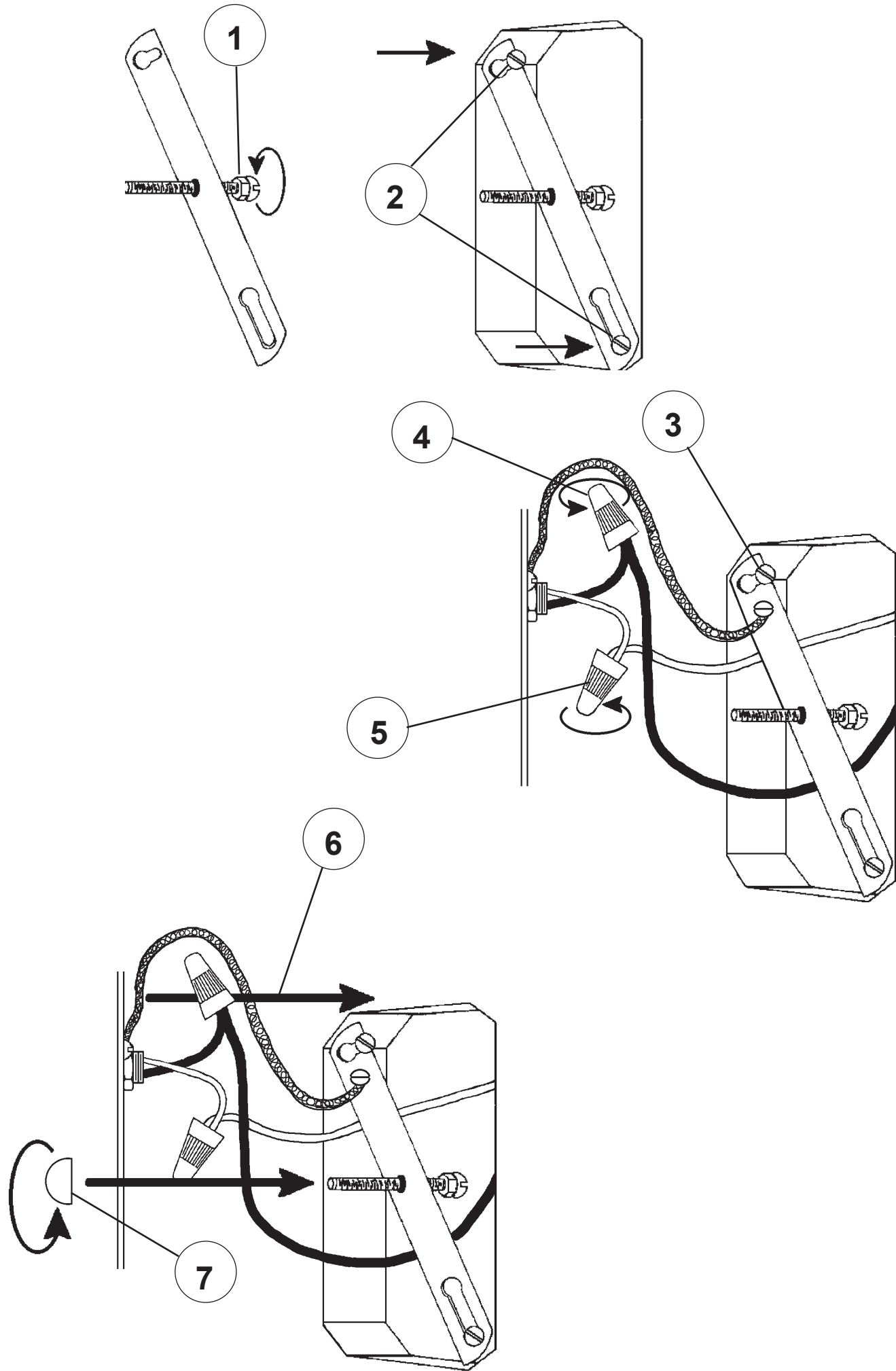



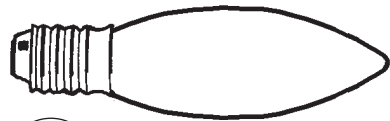

8

You will need 1 - B10
25 Watts Recommended
60 Watts Max

Install bulb and be sure
to test fixture **BEFORE**
trimming.

