

NEW ORLEANS 3657- ___ _H













10 Lights
Diameter: 28"
Body Length: 31"
Hanging Weight: 24 lbs.

THIS DESIGN IS THE PROPRIETARY
TRADE DRESS/TRADEMARK OF
W SCHONBEK LLC.

 **SCHONBEK** | 1870

 **SCHONBEK** | 1870

								
MAX 60 W		110-120 V						

All electrical components must be installed by a licensed electrician in accordance with the National Electric Code and the appropriate local electrical codes.

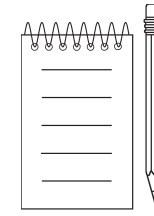
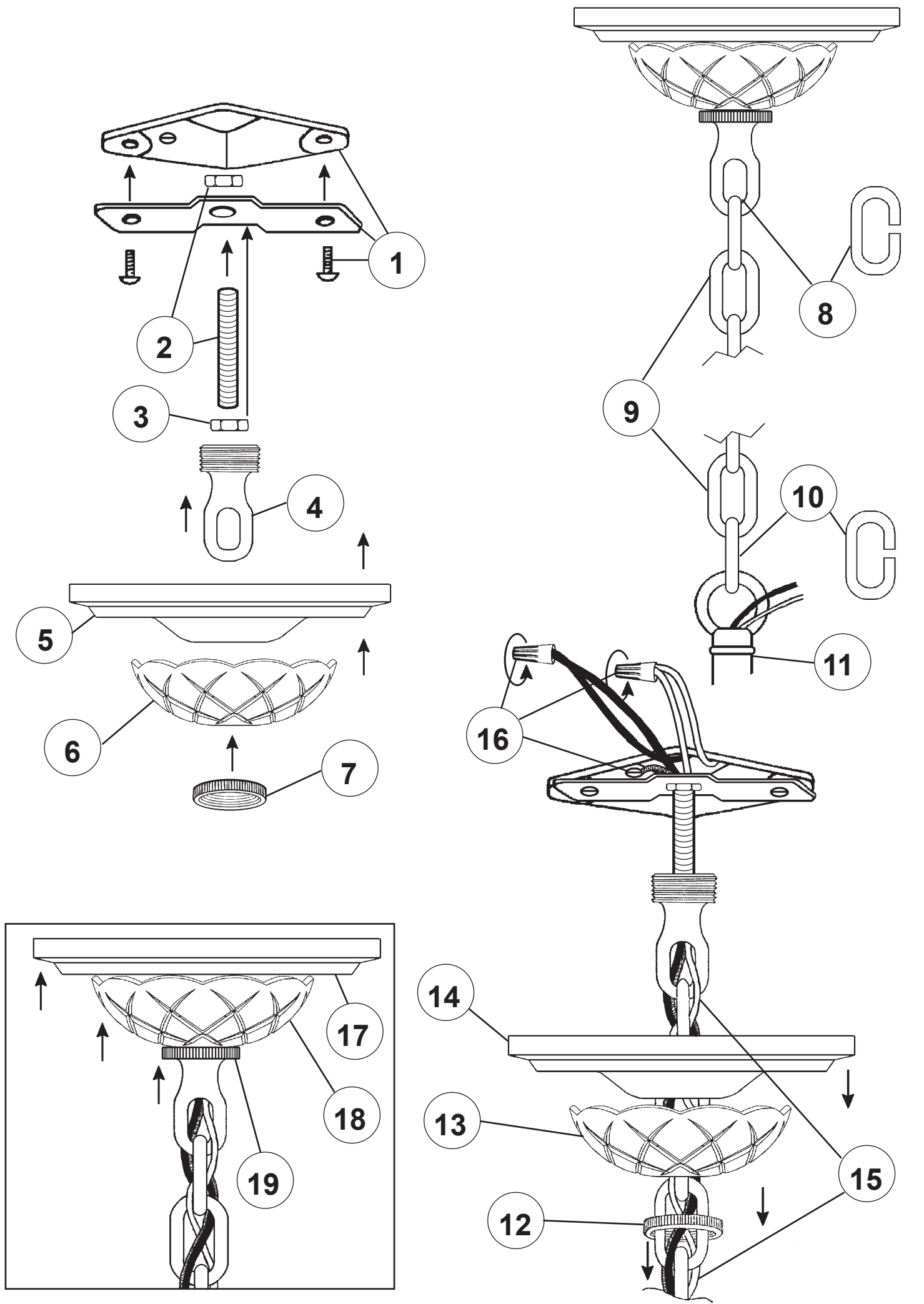



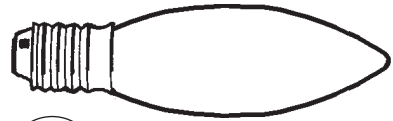

20

You will need 10 - B10
25 Watts Recommended
60 Watts Max

Install bulb and be sure
to test fixture **BEFORE**
trimming.

To protect against breakage and loss during shipping, the beads are supplied in a plastic bag, packed with the trim.

21

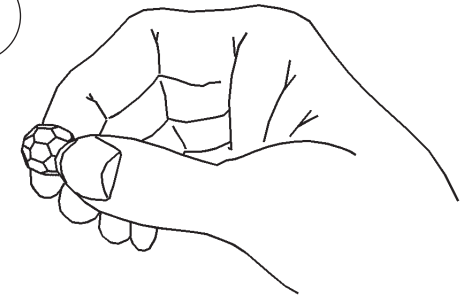

Hold bead at an angle to the arm as shown, insert one leg of the holder into the arm and, with a rolling motion across the end of the arm, push the other leg of the connector into the arm. Position so that the bead is in the center of the arm.

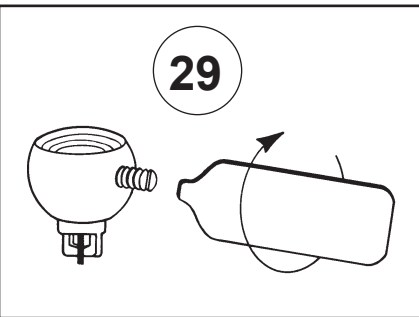
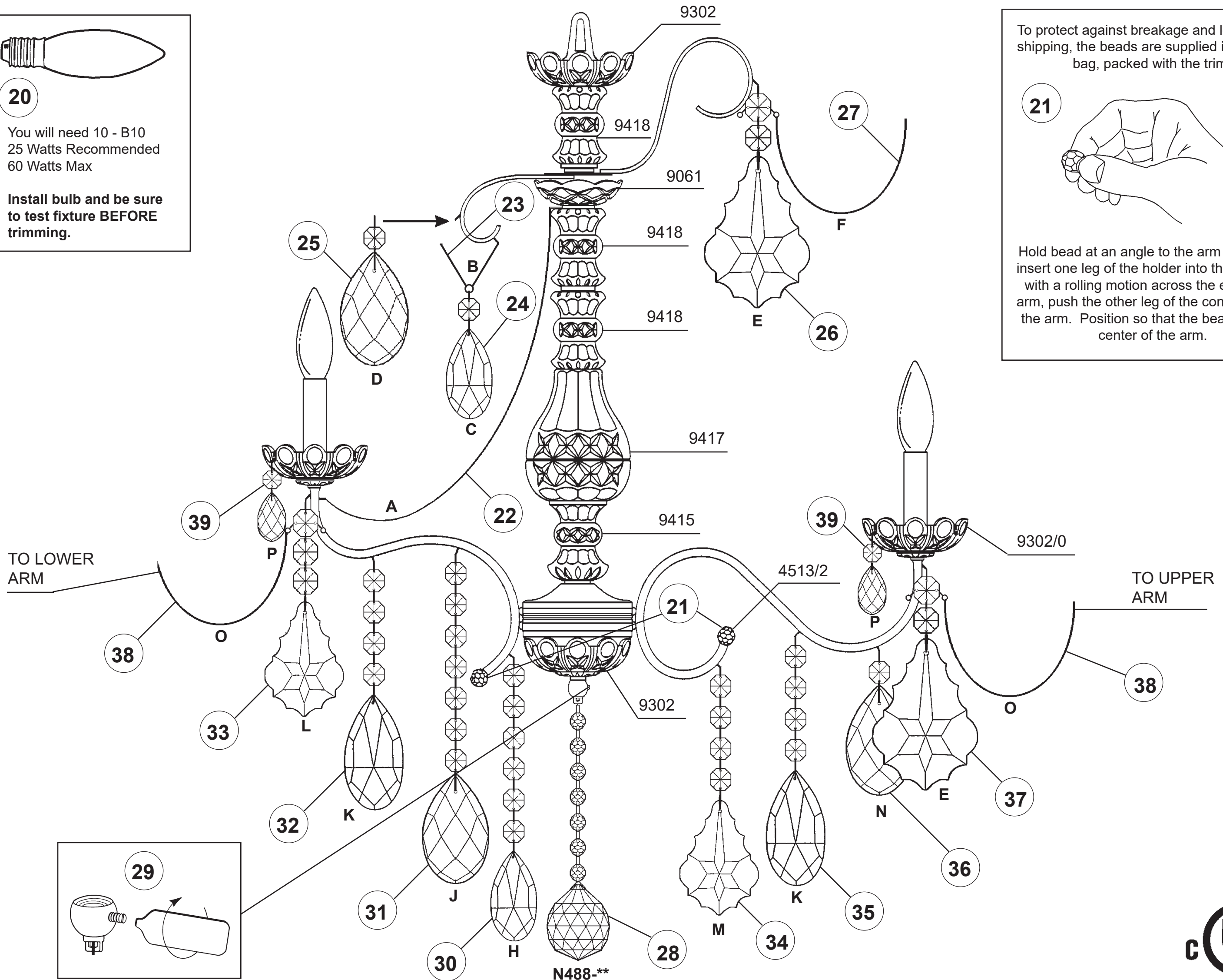

29



NEW ORLEANS 3657- __ __ R













10 Lights
Diameter: 28"
Body Length: 31"
Hanging Weight: 24 lbs.

THIS DESIGN IS THE PROPRIETARY
TRADE DRESS/TRADEMARK OF
W SCHONBEK LLC.

 **SCHONBEK** | 1870

 **SCHONBEK** | 1870

								
MAX 60 W		110-120 V						

All electrical components must be installed by a licensed electrician in accordance with the National Electric Code and the appropriate local electrical codes.

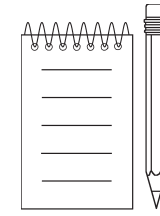
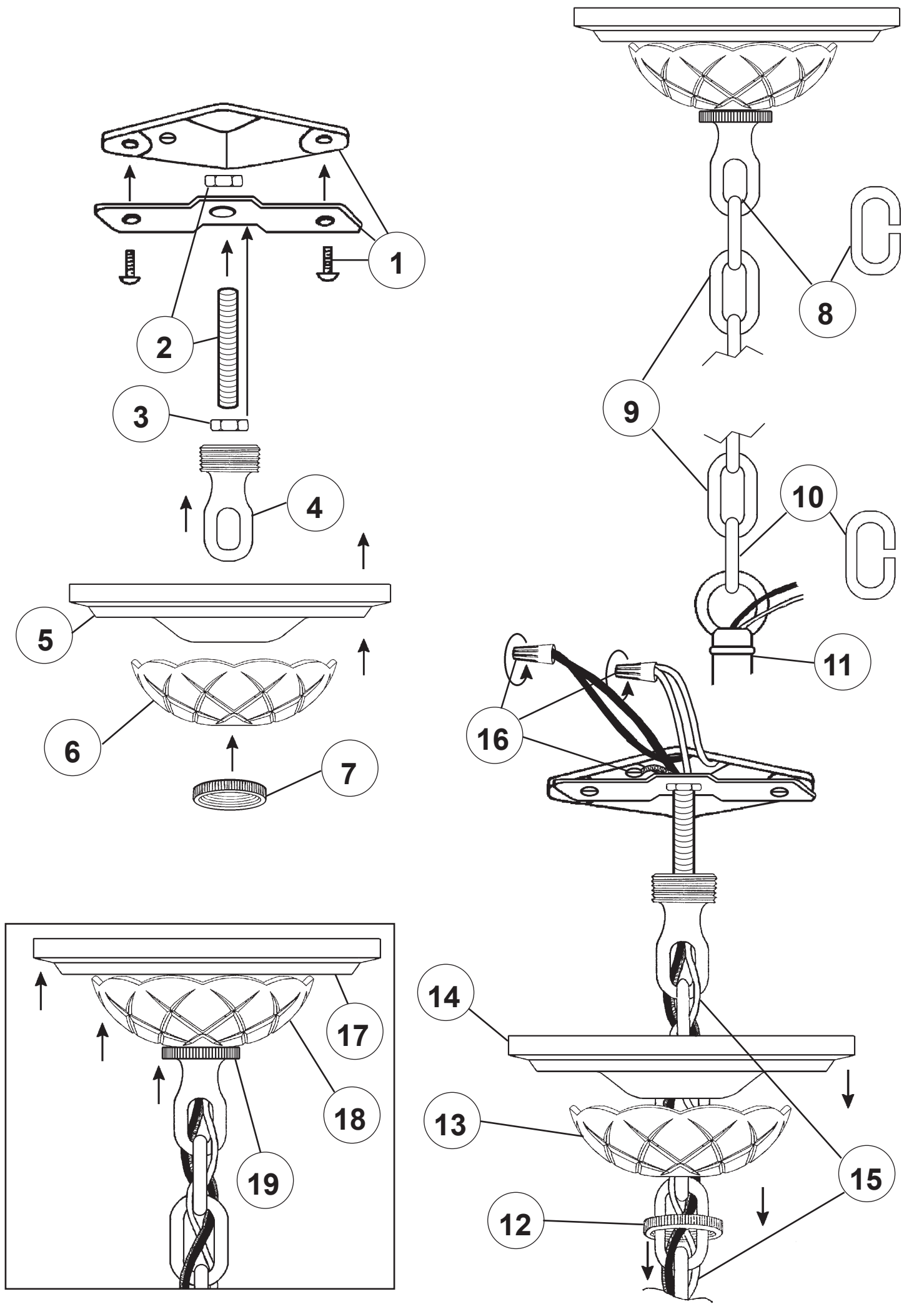

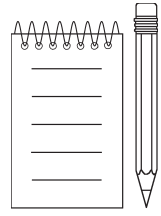

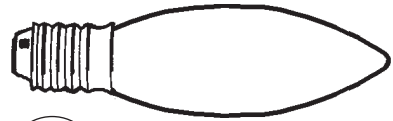

20

You will need 10 - B10
25 Watts Recommended
60 Watts Max

Install bulb and be sure
to test fixture **BEFORE**
trimming.

To protect against breakage and loss during shipping, the beads are supplied in a plastic bag, packed with the trim.

21

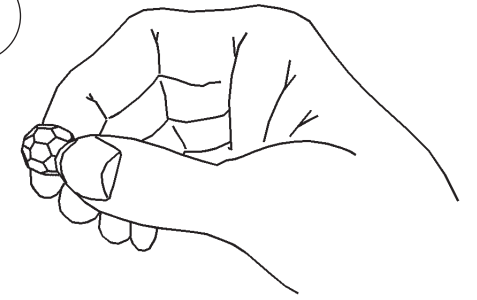

Hold bead at an angle to the arm as shown, insert one leg of the holder into the arm and, with a rolling motion across the end of the arm, push the other leg of the connector into the arm. Position so that the bead is in the center of the arm.

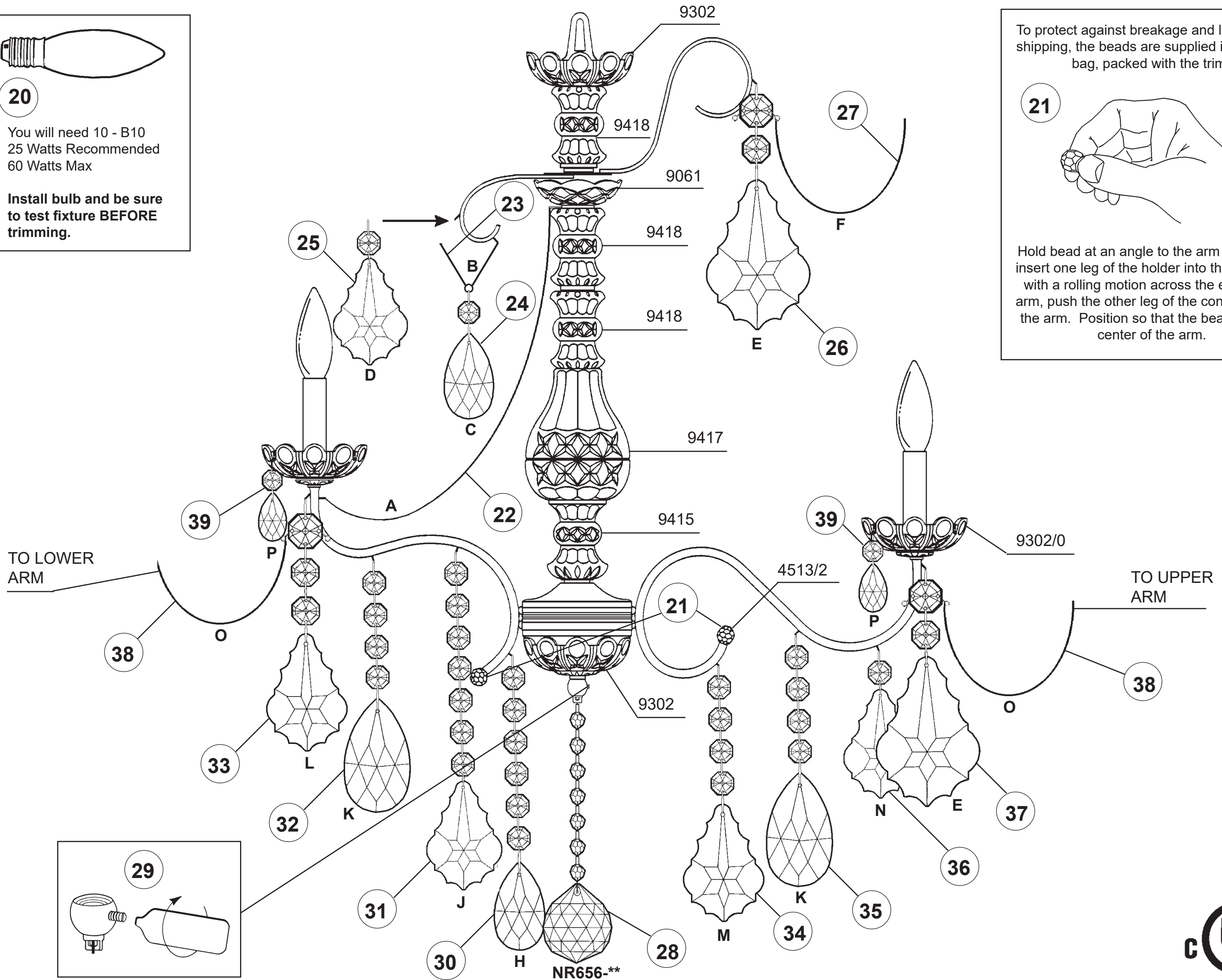

NR656-**



NEW ORLEANS 3657- __ __ S



10 Lights
Diameter: 28"
Body Length: 31"
Hanging Weight: 24 lbs.

THIS DESIGN IS THE PROPRIETARY
TRADE DRESS/TRADEMARK OF
W SCHONBEK LLC.

 **SCHONBEK** | 1870

 **SCHONBEK** | 1870

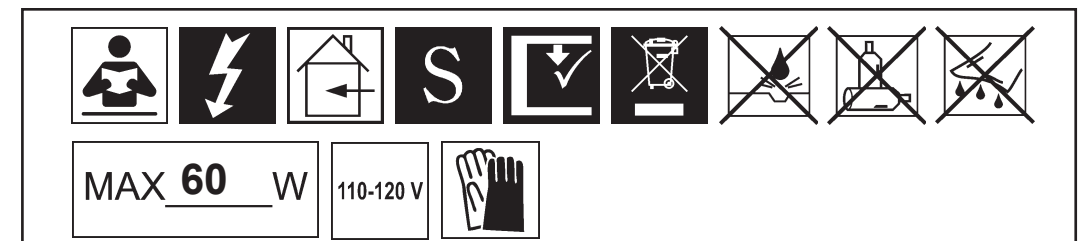

All electrical components must be installed by a licensed electrician in accordance with the National Electric Code and the appropriate local electrical codes.

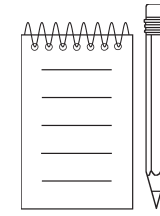
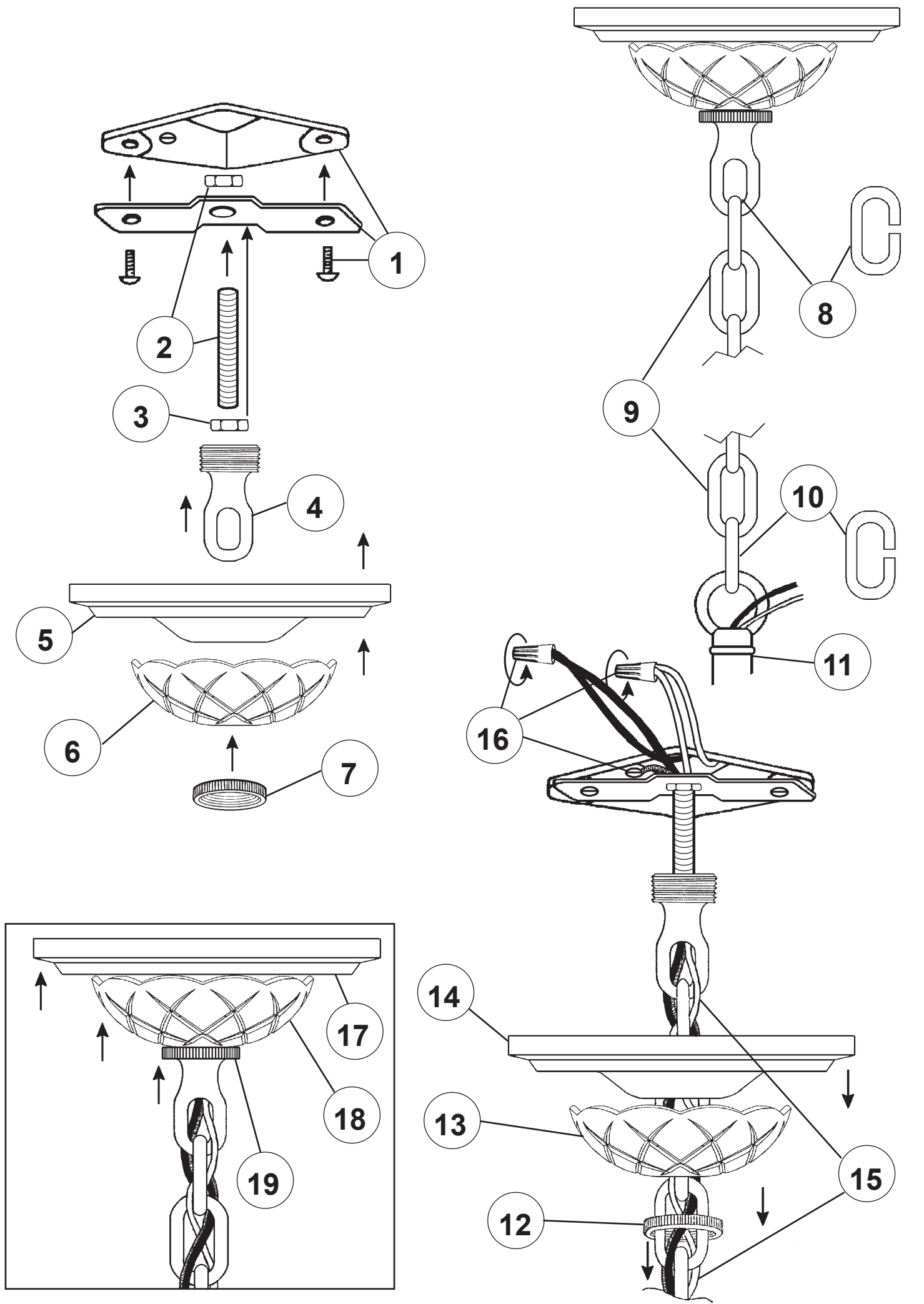



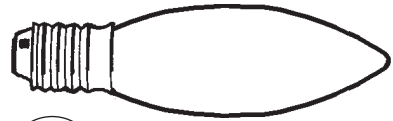

20

You will need 10 - B10
25 Watts Recommended
60 Watts Max

Install bulb and be sure
to test fixture **BEFORE**
trimming.

To protect against breakage and loss during shipping, the beads are supplied in a plastic bag, packed with the trim.

21

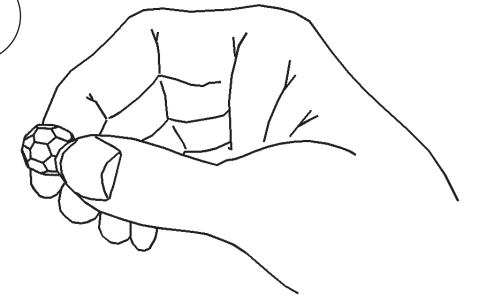

Hold bead at an angle to the arm as shown, insert one leg of the holder into the arm and, with a rolling motion across the end of the arm, push the other leg of the connector into the arm. Position so that the bead is in the center of the arm.

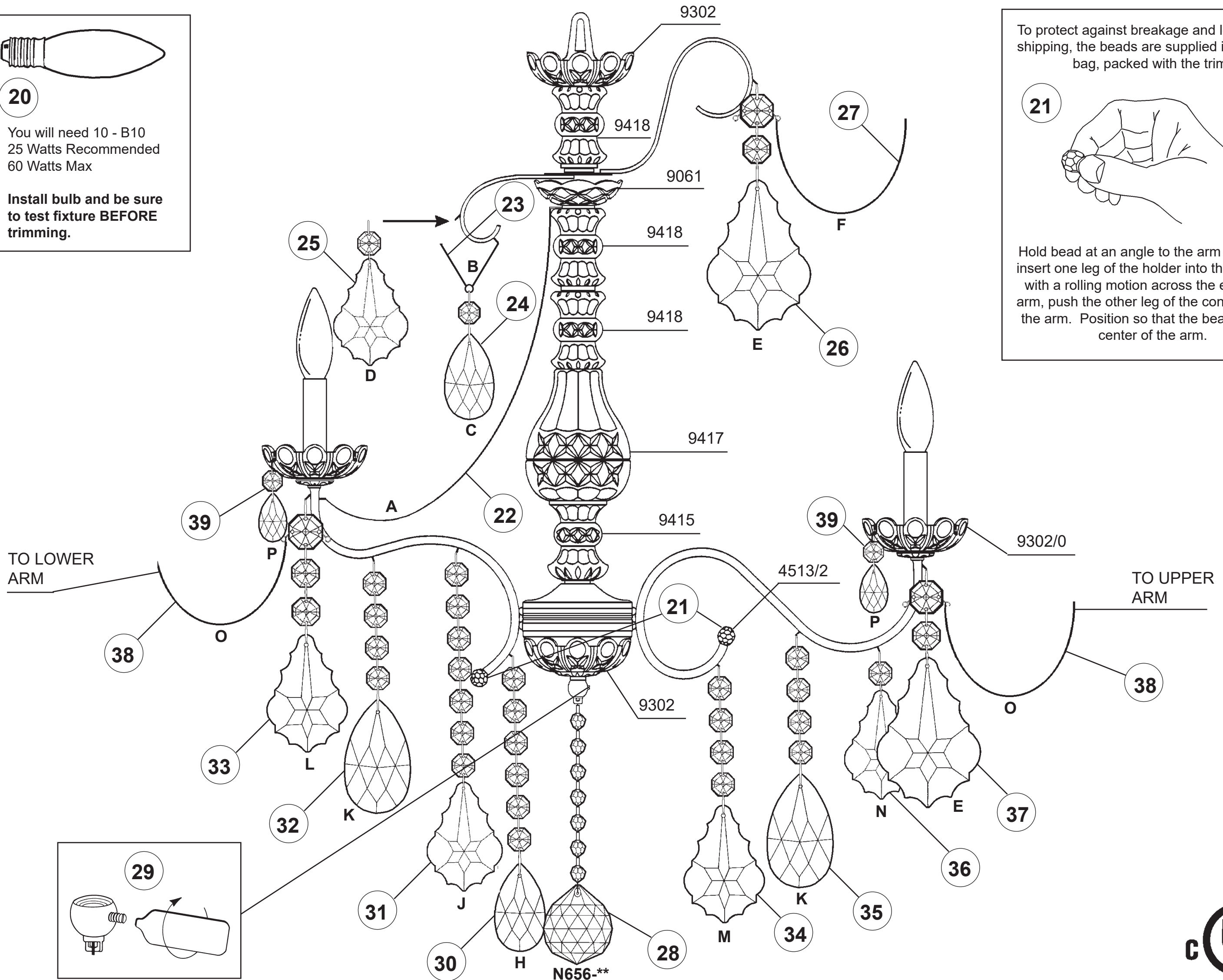

TO LOWER
ARM

TO UPPER
ARM

N656-**

