

 **SCHONBEK** | 1870

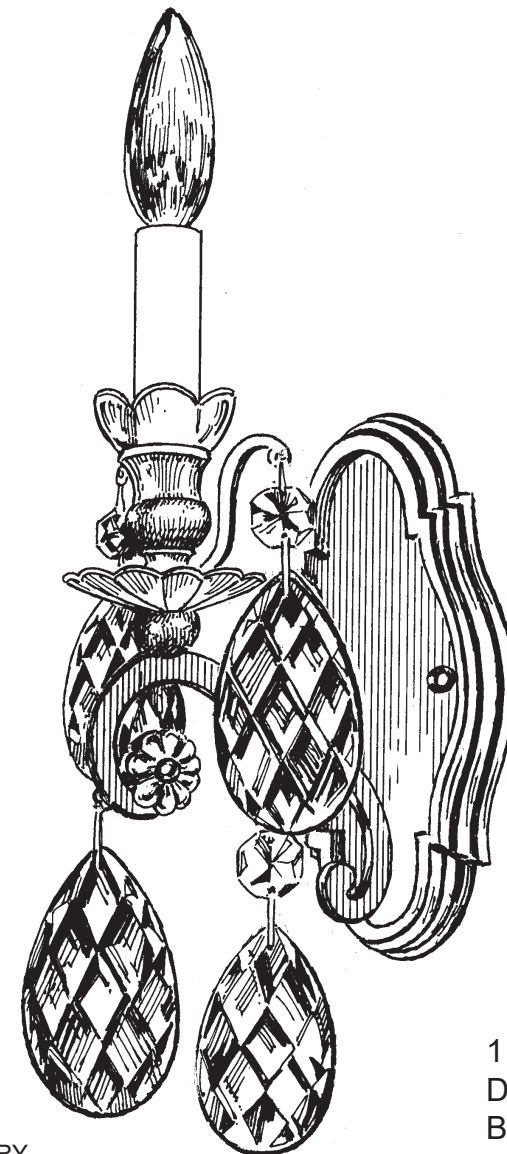









RENAISSANCE 3756- _ _ _



THIS DESIGN IS THE PROPRIETARY TRADE DRESS/TRADEMARK OF W SCHONBEK LLC.

1 Light
Diameter: 6"
Body Length: 15-1/2"
Extension: 5-1/2"
Hanging Weight: 3-1/2 lbs.

 **SCHONBEK** | 1870

								
MAX 60 W	110-120 V							

All electrical components must be installed by a licensed electrician in accordance with the National Electric Code and the appropriate local electrical codes.

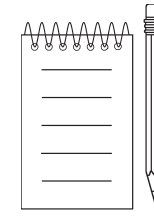
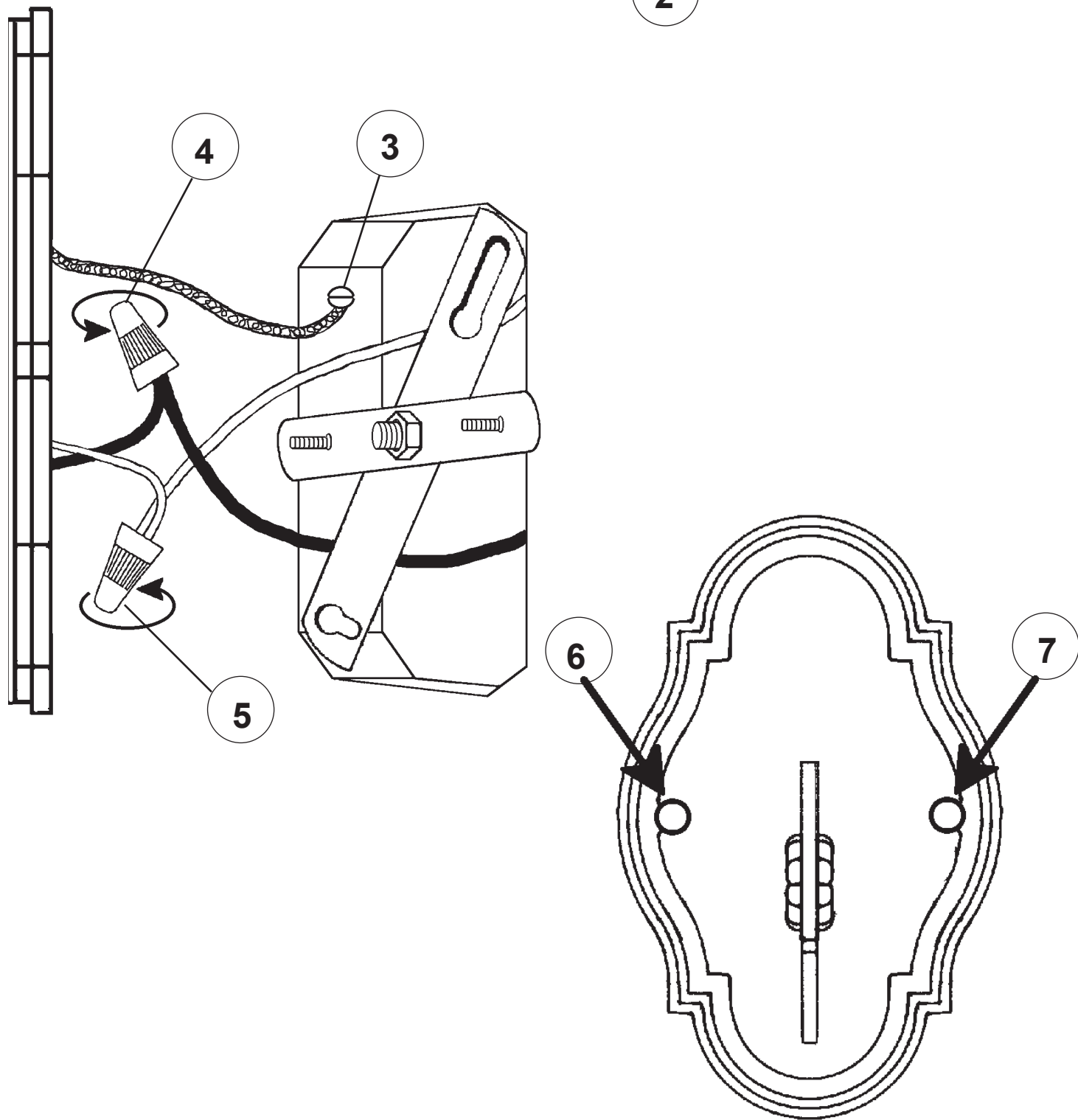
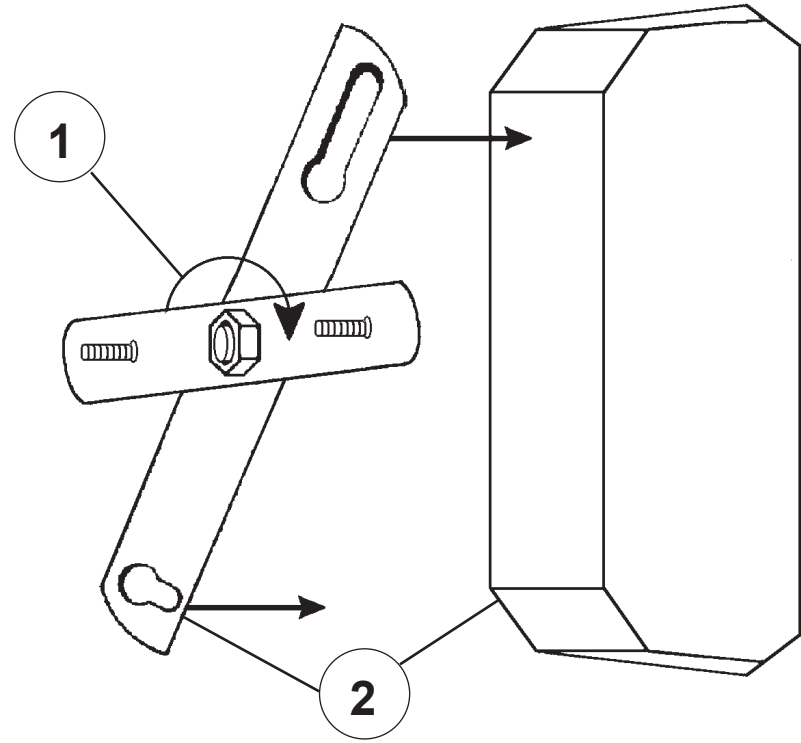

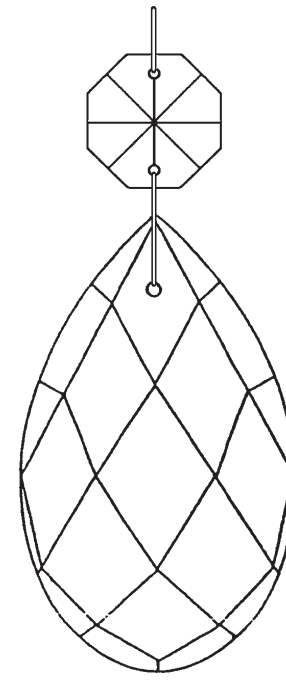

N4000
3"
76mm

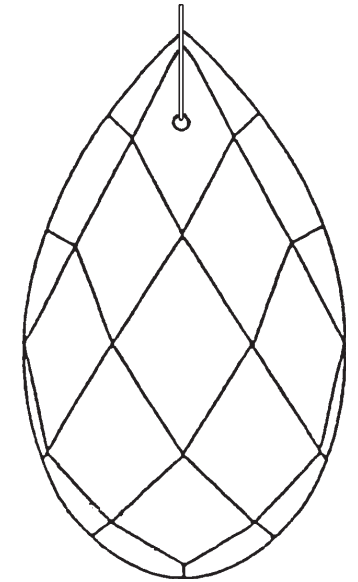

N4001
3-1/2"
89mm

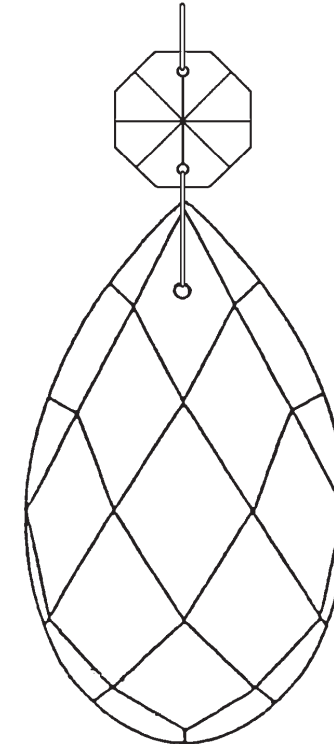

N4007
3-1/2"
89mm



9

You will need 1 - B10
25 Watts Recommended
60 Watts Max

Install bulb and be sure
to test fixture **BEFORE**
trimming.

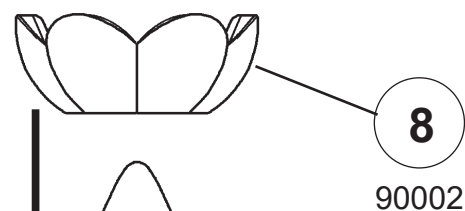

8

90002

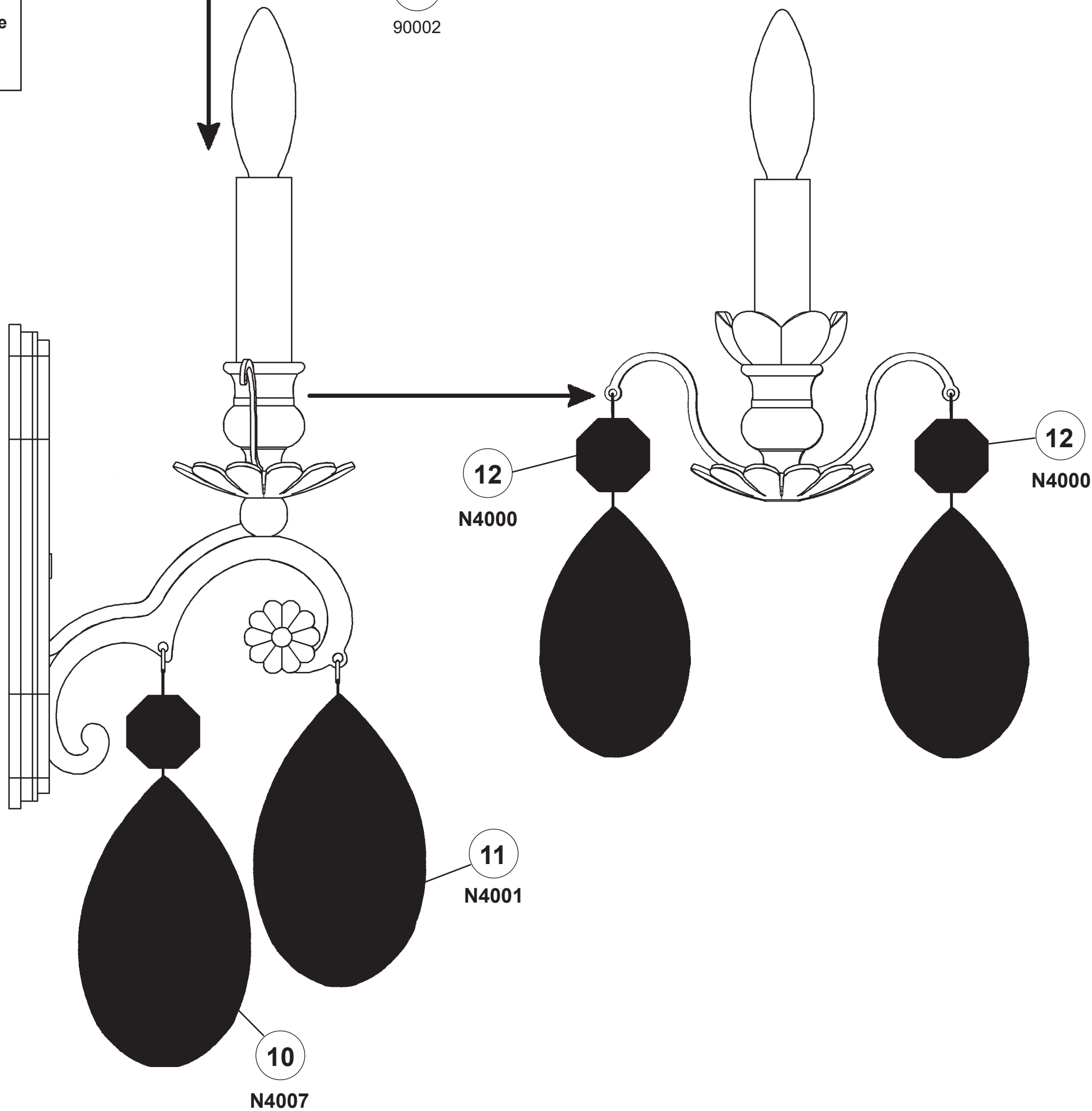

12
N4000

12
N4000

11
N4001

10
N4007



RENAISSANCE 3756- _____

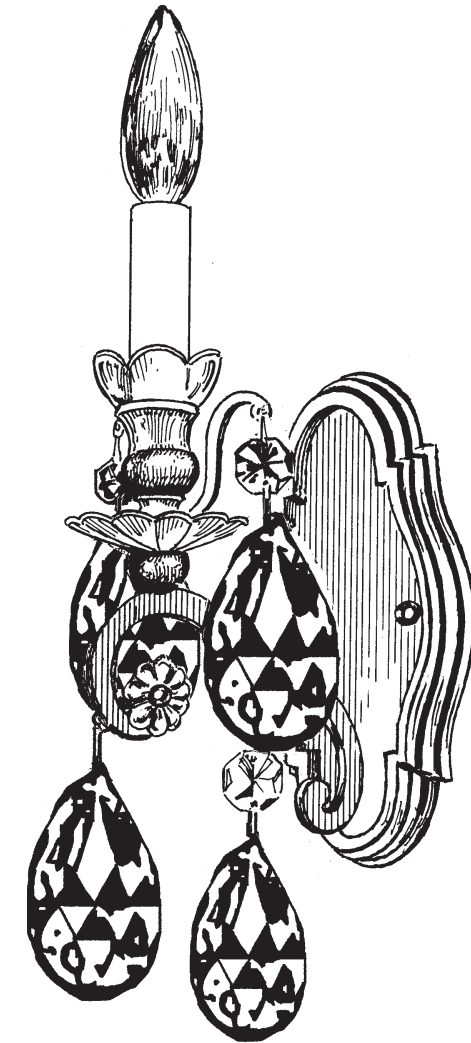











1 Light
Diameter: 6"
Body Length: 15-1/2"
Extension: 5-1/2"
Hanging Weight: 3-1/2 lbs.

THIS DESIGN IS THE PROPRIETARY
TRADE DRESS/TRADEMARK OF
W SCHONBEK LLC.

 **SCHONBEK** | 1870

 **SCHONBEK** | 1870

								
MAX 60 W	110-120 V							

All electrical components must be installed by a licensed electrician in accordance with the National Electric Code and the appropriate local electrical codes.

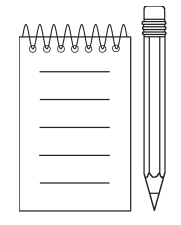
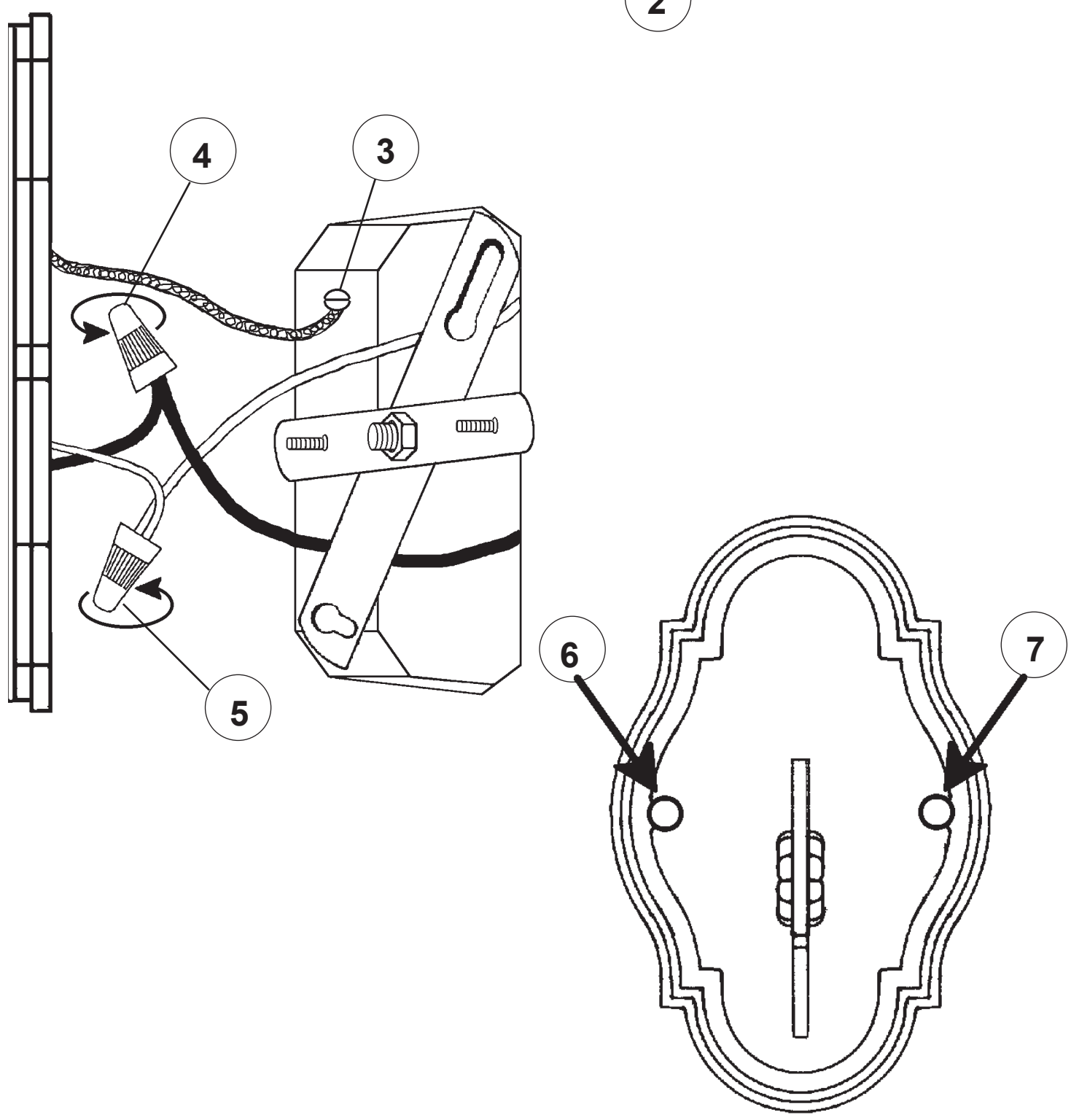
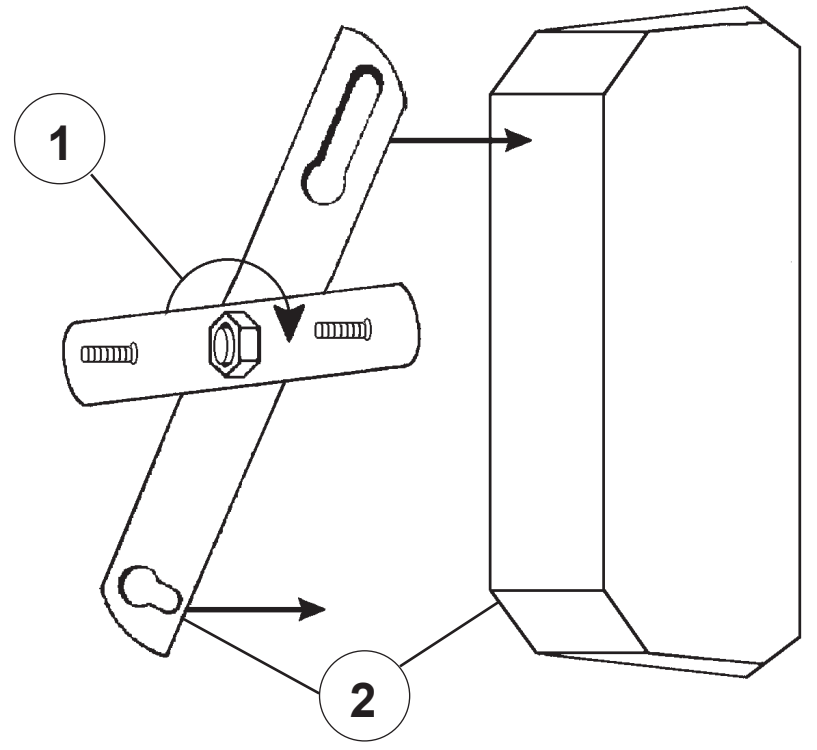

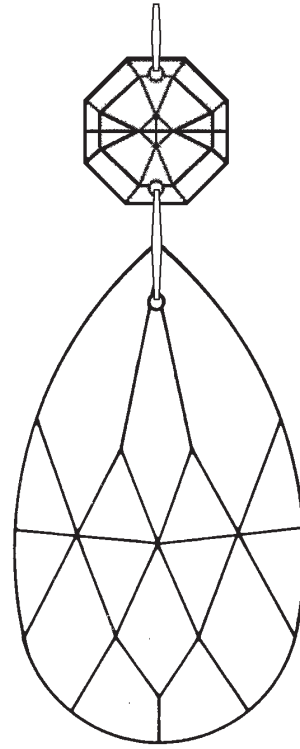
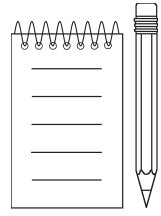

N4000-**
3"
76mm

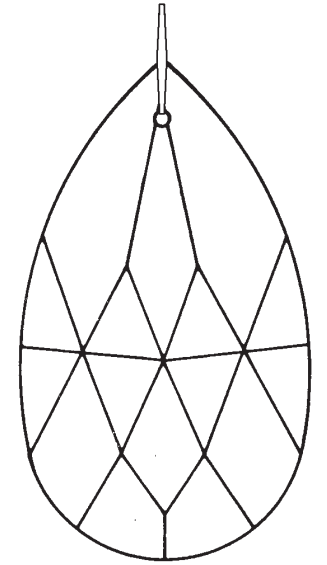

N4004-**
3"
76mm

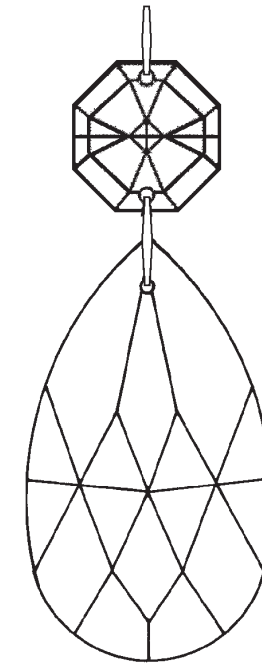

N4003-**
2-1/2"
63mm

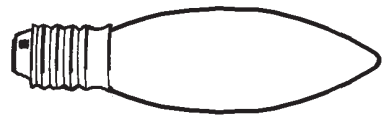

9

You will need 1 - B10
25 Watts Recommended
60 Watts Max

Install bulb and be sure
to test fixture **BEFORE**
trimming.

