

 **SCHONBEK** | 1870

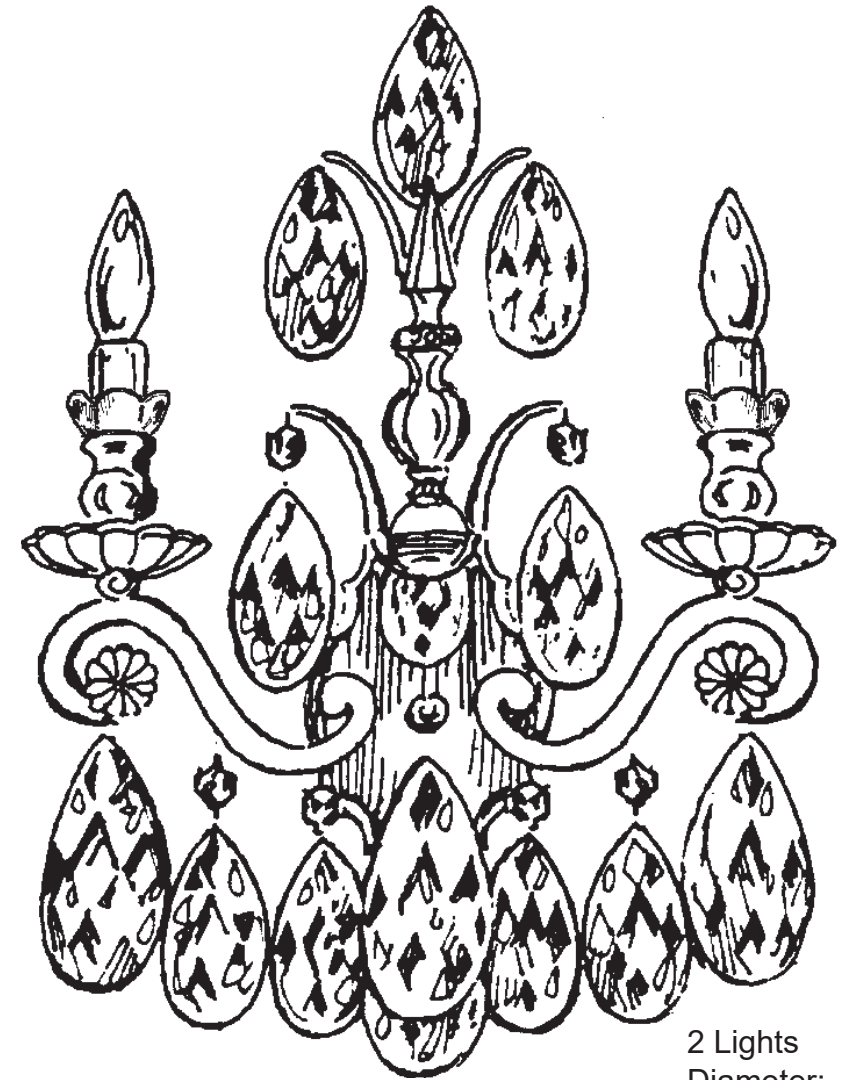









RENAISSANCE 3761- _ _ _



2 Lights
Diameter: 15"
Body Length: 22-1/2"
Extension: 8"
Hanging Weight: 8 lbs.

THIS DESIGN IS THE PROPRIETARY
TRADE DRESS/TRADEMARK OF
W SCHONBEK LLC.

 **SCHONBEK** | 1870

								
MAX 60 W	110-120 V							

All electrical components must be installed by a licensed electrician in accordance with the National Electric Code and the appropriate local electrical codes.

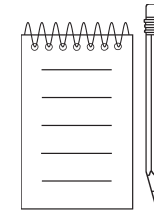
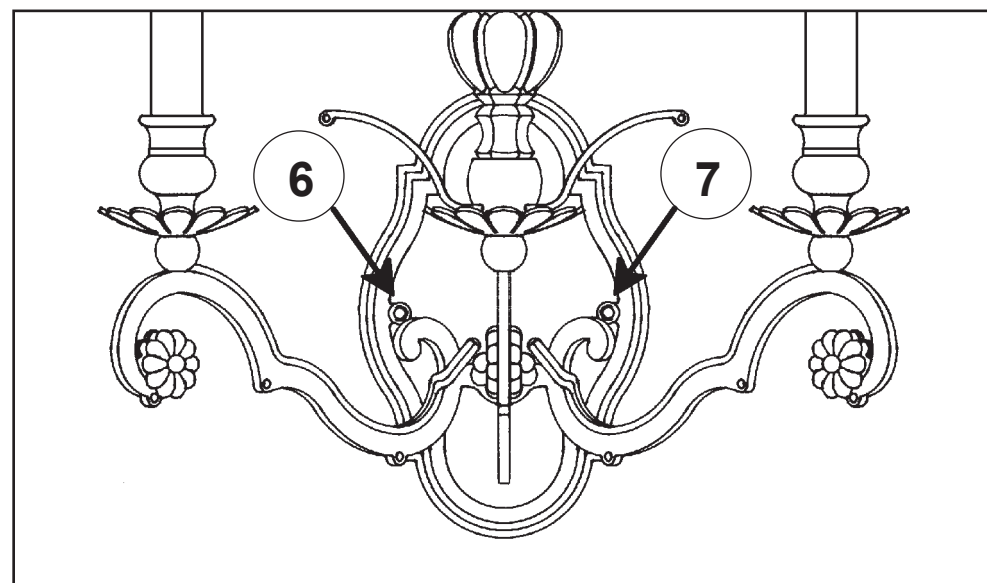
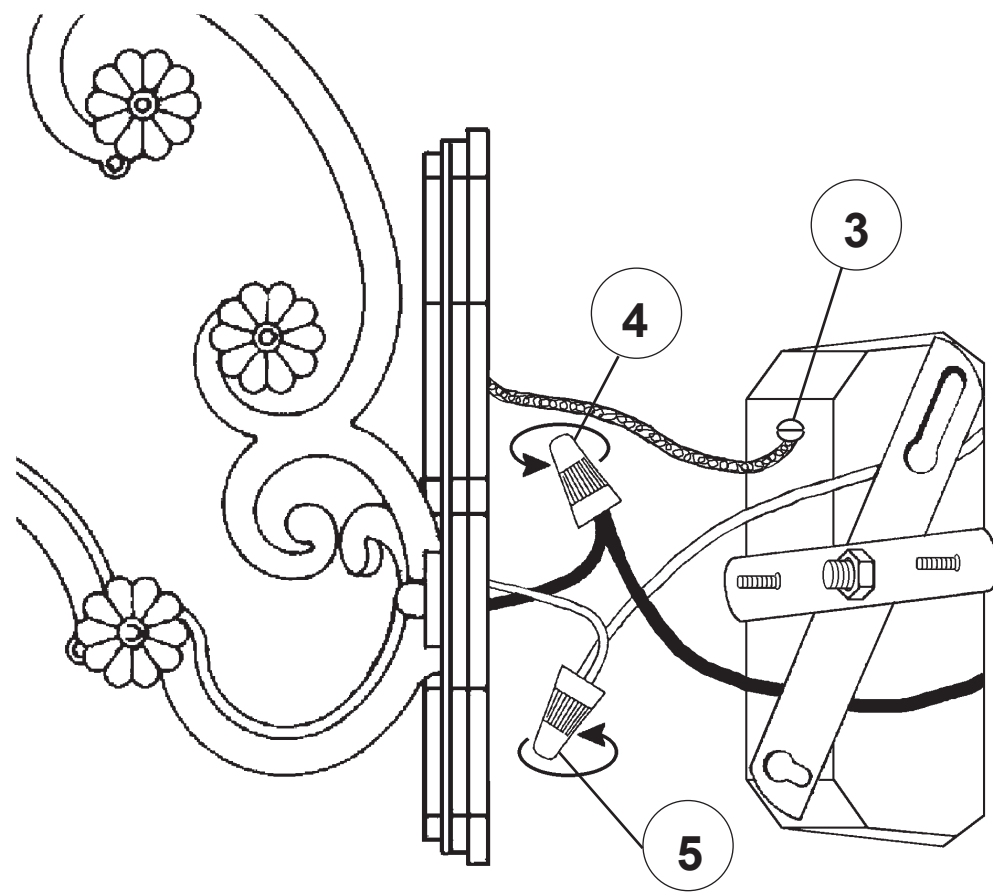
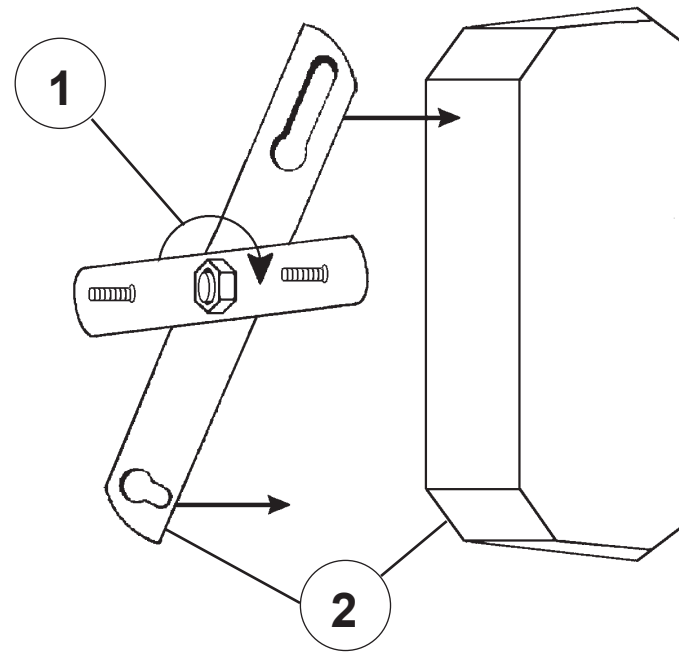



SET 1

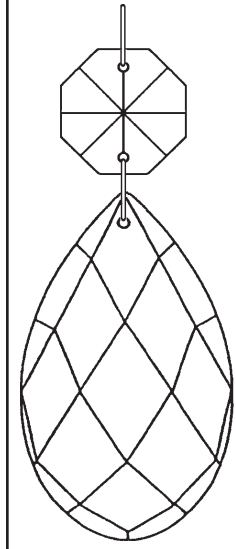

N4003
2-1/2"
63mm

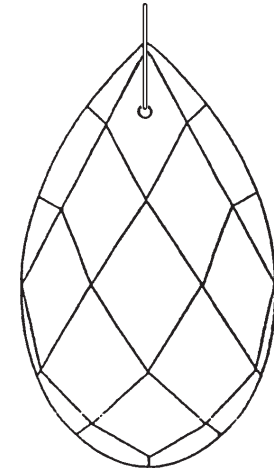

N4004
3"
76mm

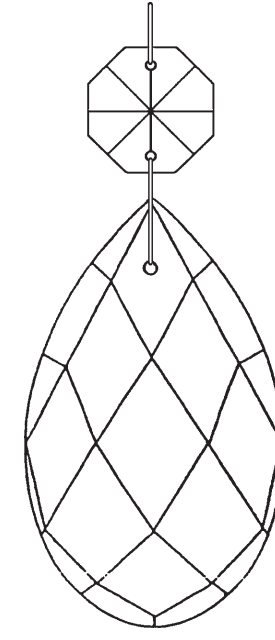

N4000
3"
76mm

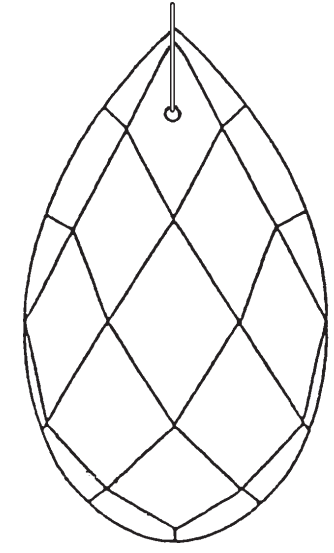

N4001
3-1/2"
89mm

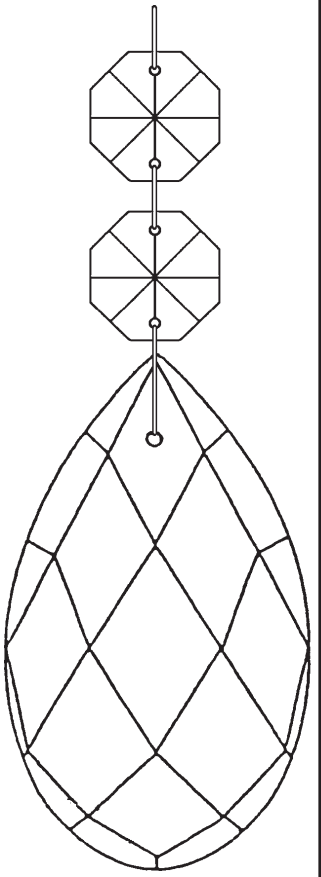

N4002
3-1/2"
89mm

SET 2

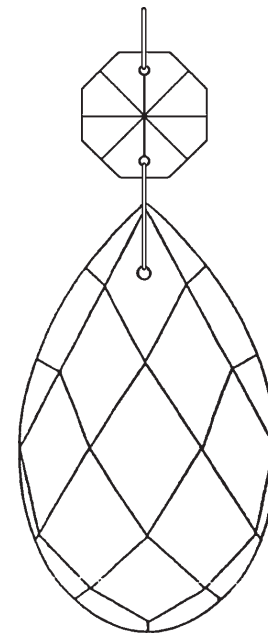

N4000
3"
76mm

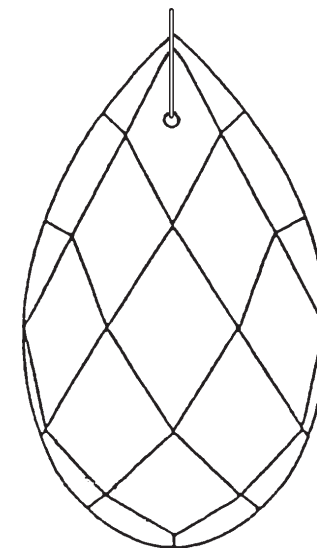

N4001
3-1/2"
89mm

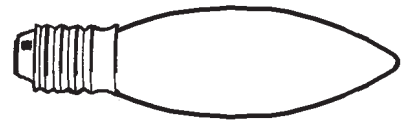

9 2 - B10
60 Watts Max
25 Watts Recommend

Crystal Set 1 in Black

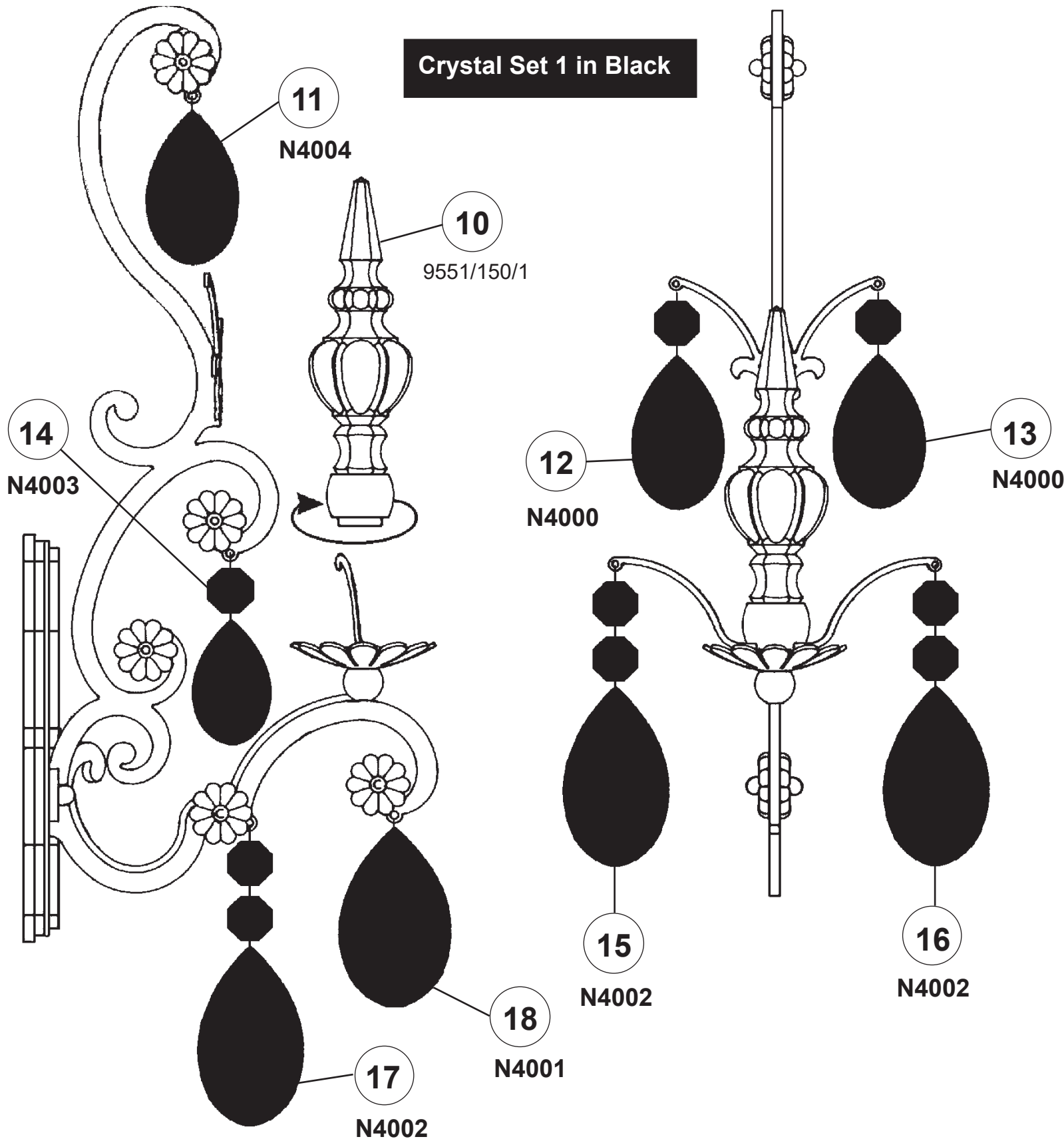

Crystal Set 2 in Black

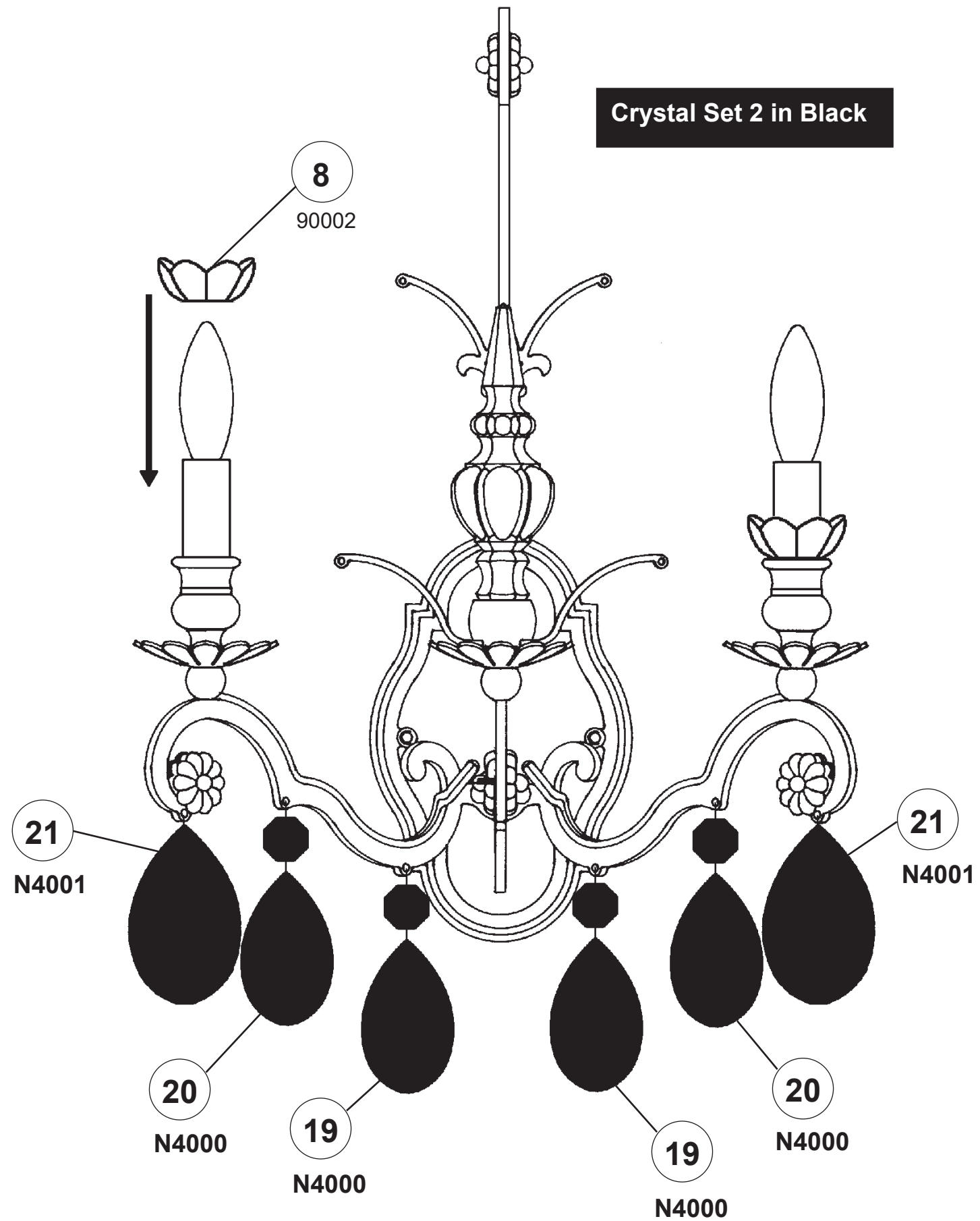

RENAISSANCE 3761- _____

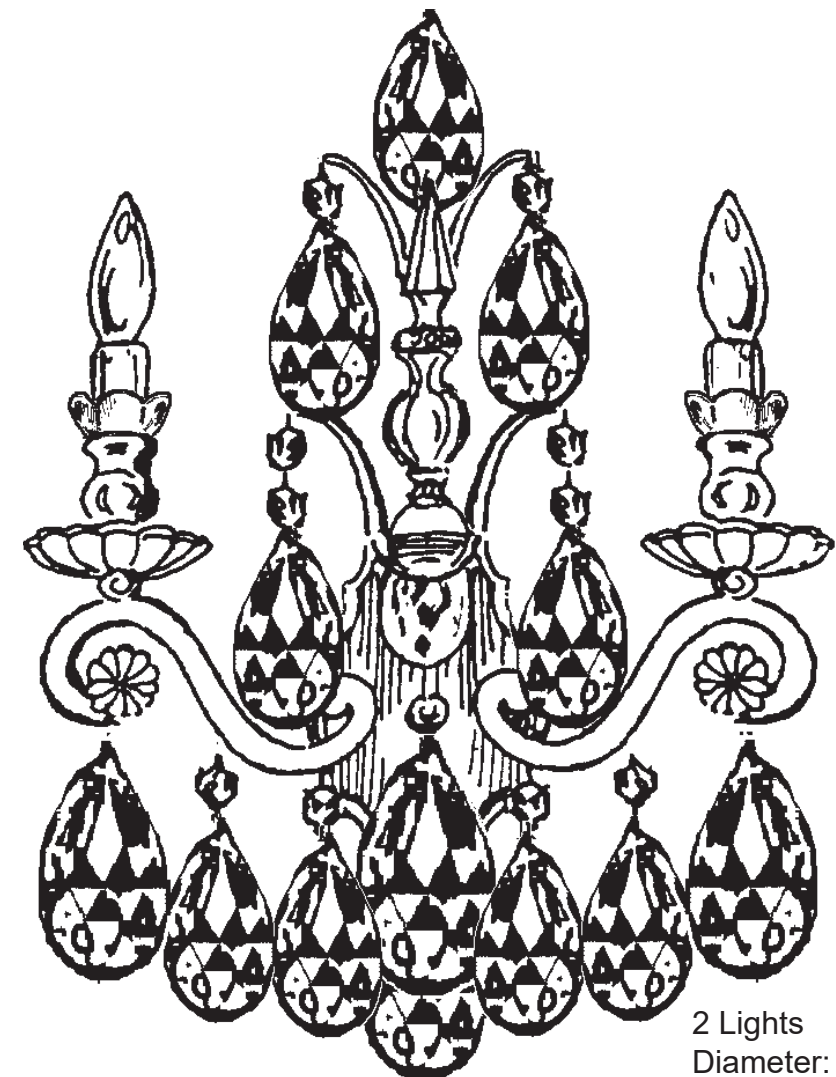











2 Lights
Diameter: 15"
Body Length: 22-1/2"
Extension: 8"
Hanging Weight: 8 lbs.

THIS DESIGN IS THE PROPRIETARY
TRADE DRESS/TRADEMARK OF
W SCHONBEK LLC.

 **SCHONBEK** | 1870

 **SCHONBEK** | 1870

								
MAX 60 W	110-120 V							

All electrical components must be installed by a licensed electrician in accordance with the National Electric Code and the appropriate local electrical codes.

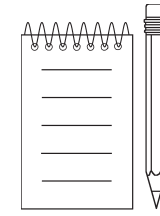
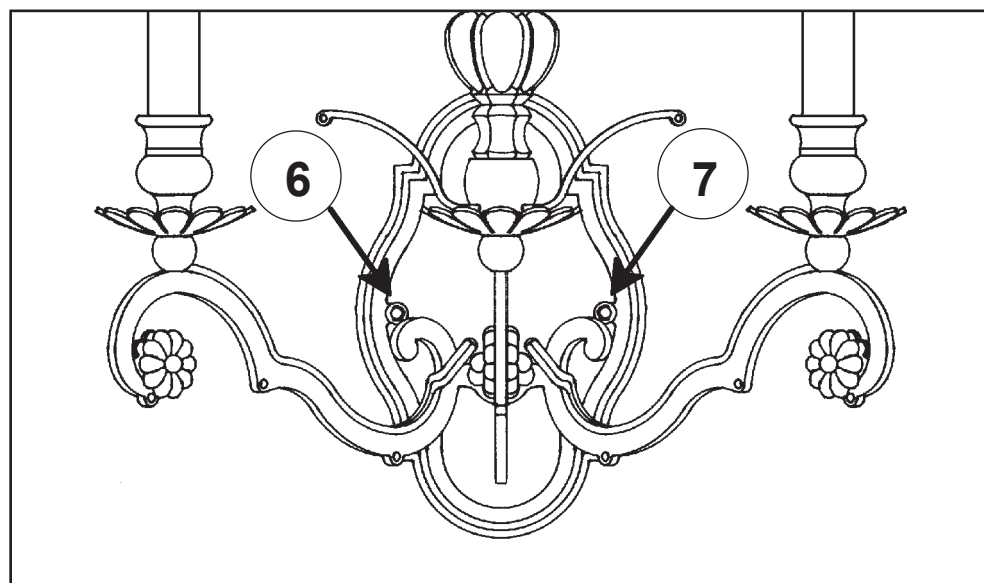
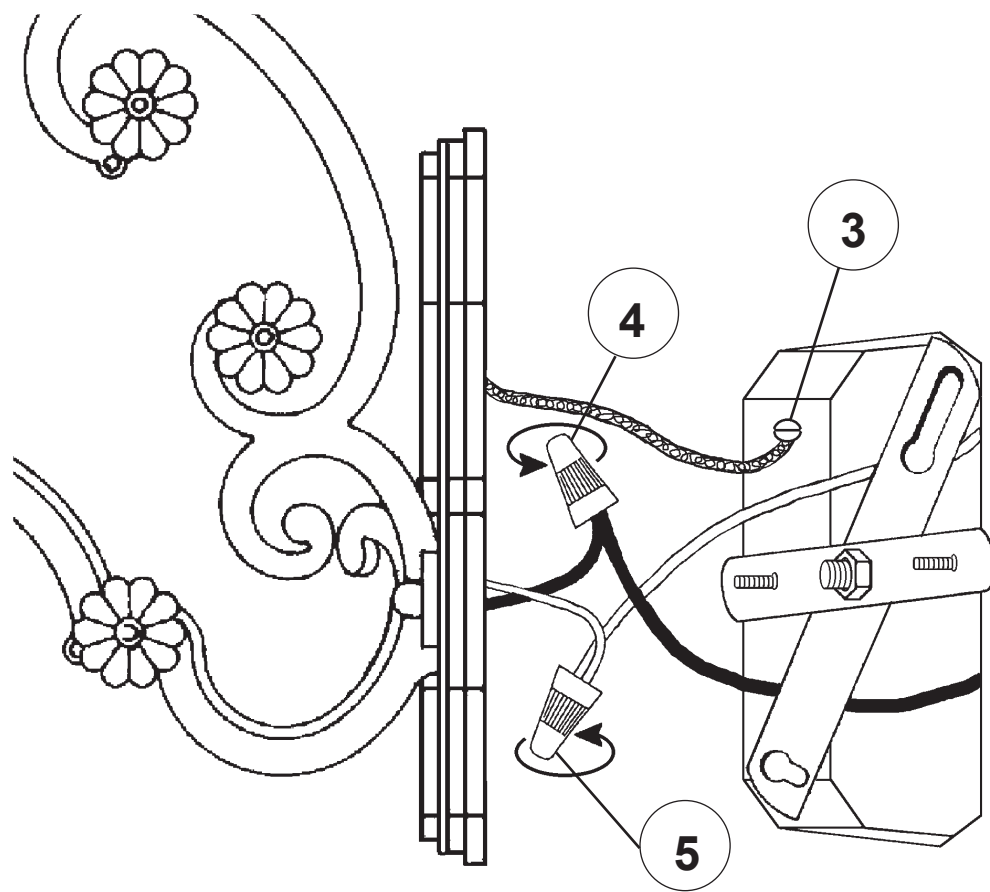
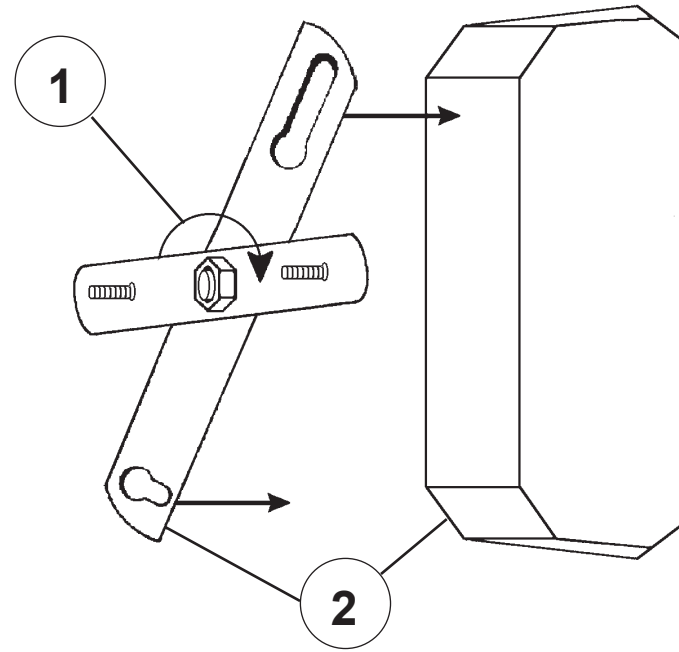

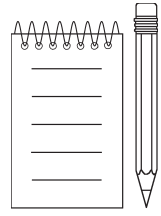

SET 1

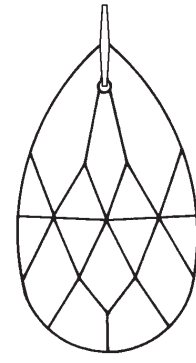

N2793-**
2"
50mm

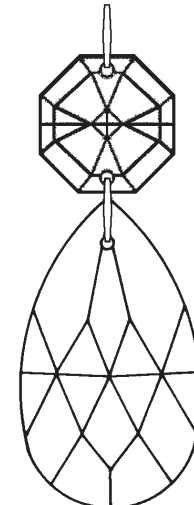

N4044-**
2"
50mm

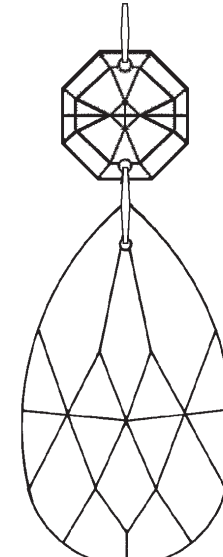

N4003-**
2-1/2"
63mm

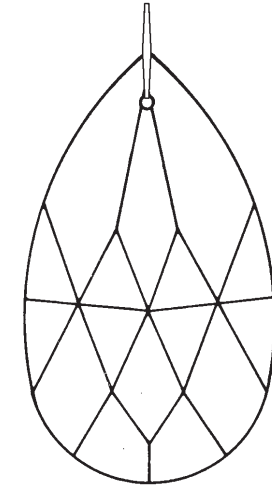

N4004-**
3"
76mm

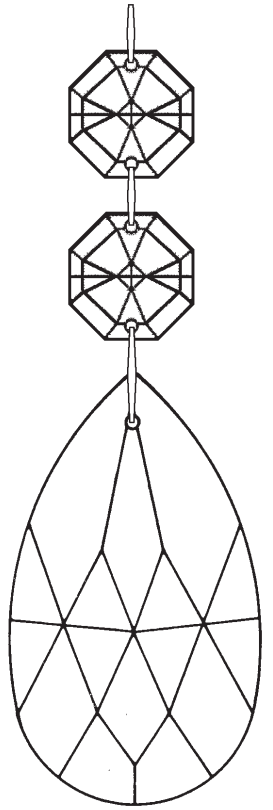

N4010-**
3"
76mm

SET 2

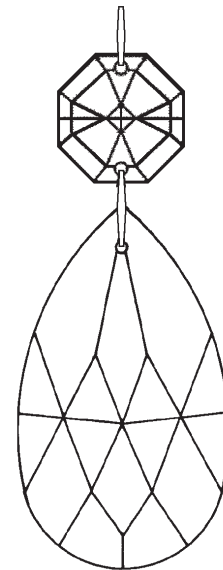

N4003-**
2-1/2"
63mm

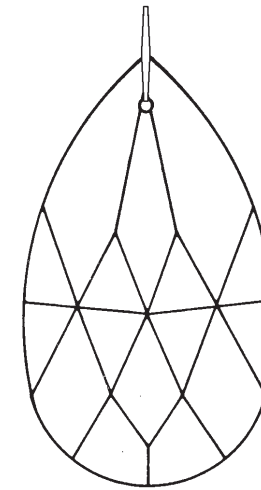

N4004-**
3"
76mm

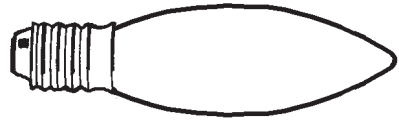

9 2 - B10
60 Watts Max
25 Watts Recommend

Crystal Set 1 in Black

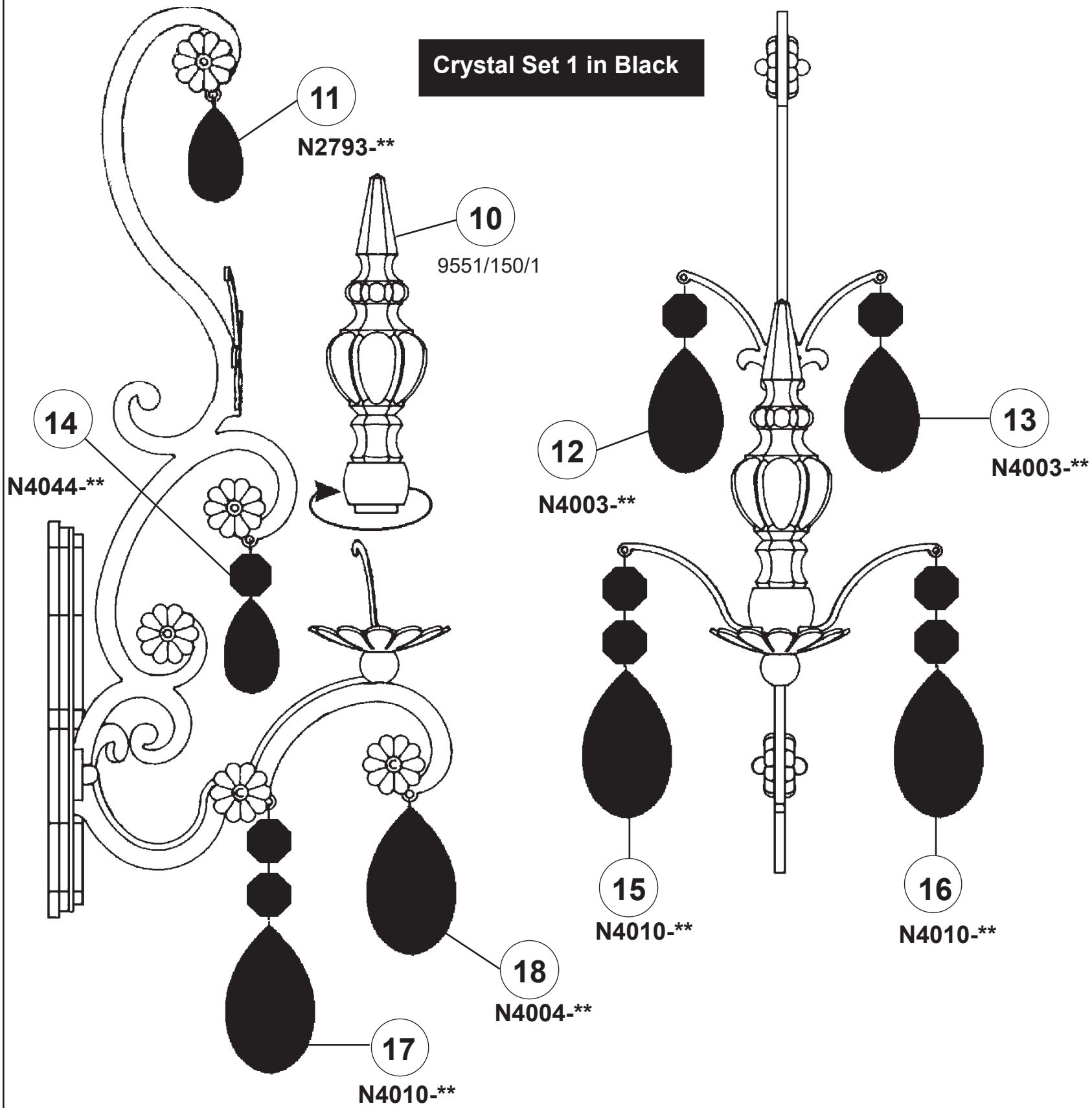

Crystal Set 2 in Black

