

RENAISSANCE 3780- ____

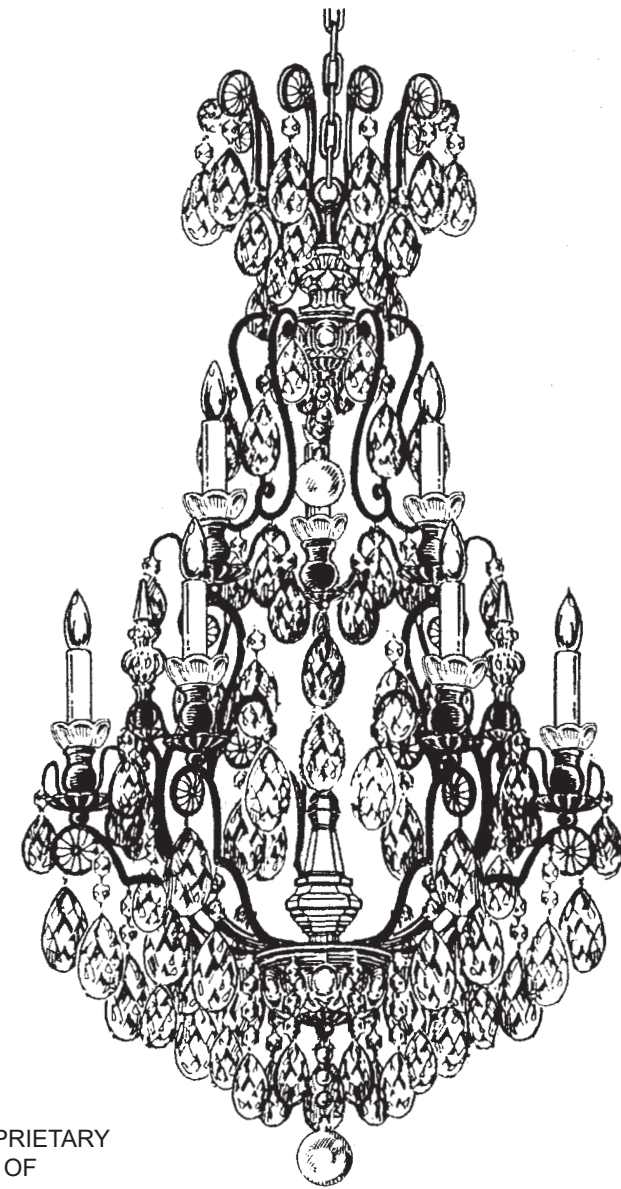











9 + 1 Lights
Diameter: 21"
Body Length: 40"
Hanging Weight: 38 lbs.

THIS DESIGN IS THE PROPRIETARY
TRADE DRESS/TRADEMARK OF
W SCHONBEK LLC.

 **SCHONBEK** | 1870

 **SCHONBEK** | 1870

								
MAX 60 W	MAX 15 W	110-120 V						

Crystal Set 3 in Black

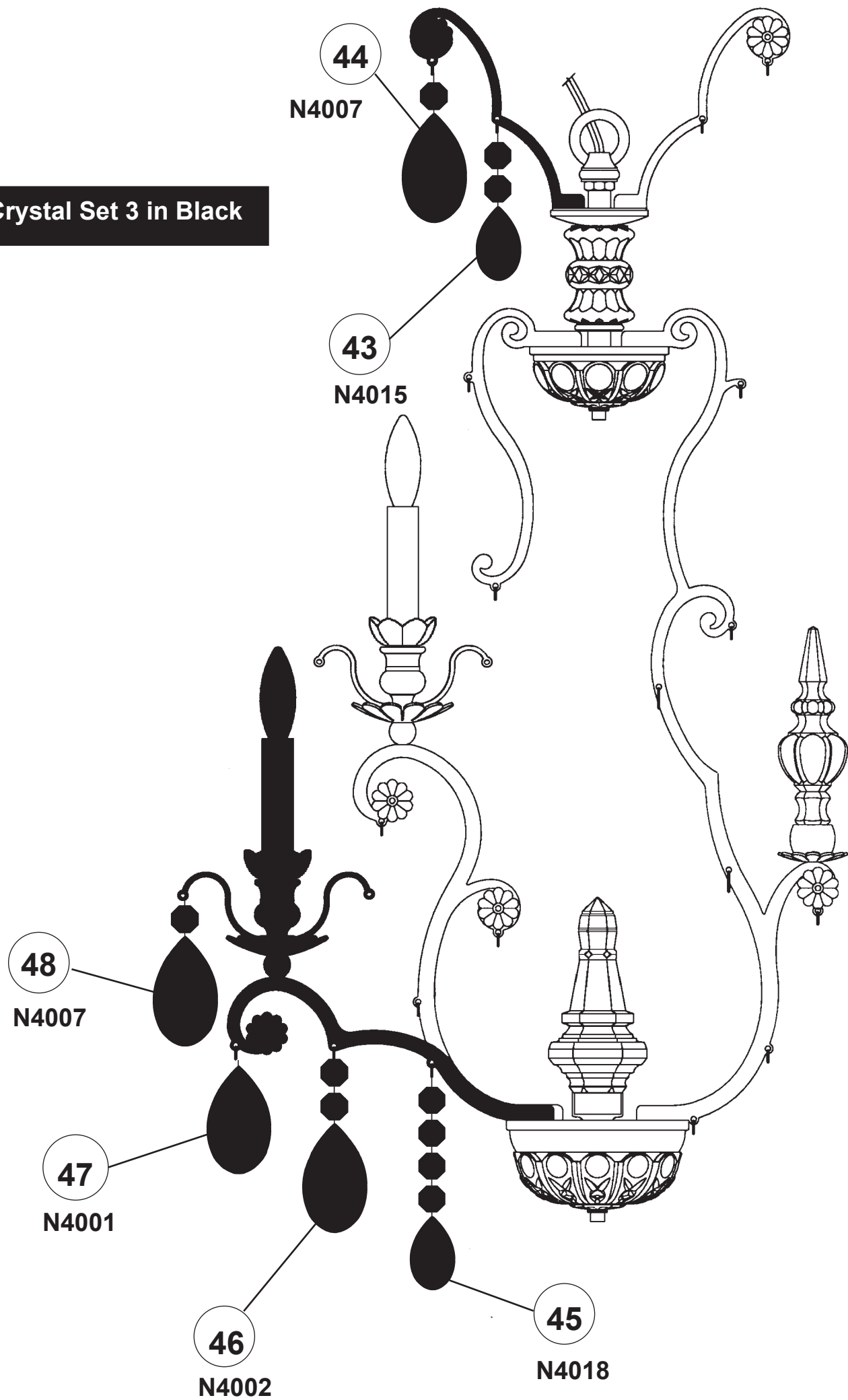

SET 1

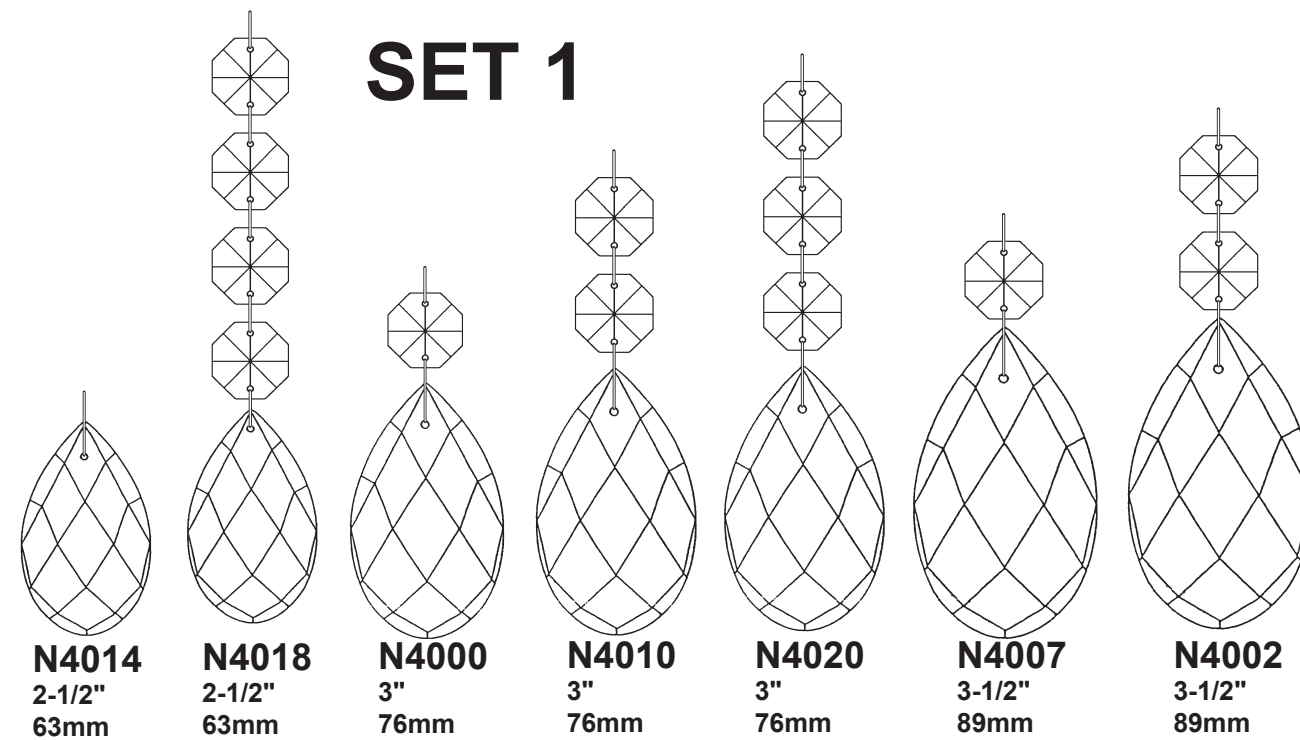

SET 2

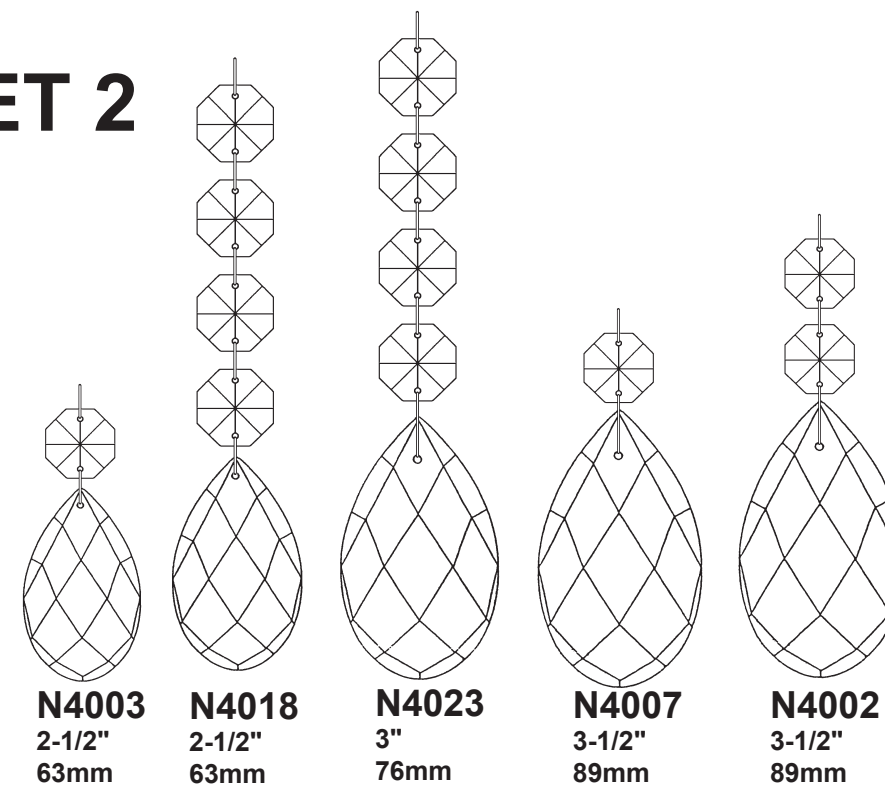

SET 3

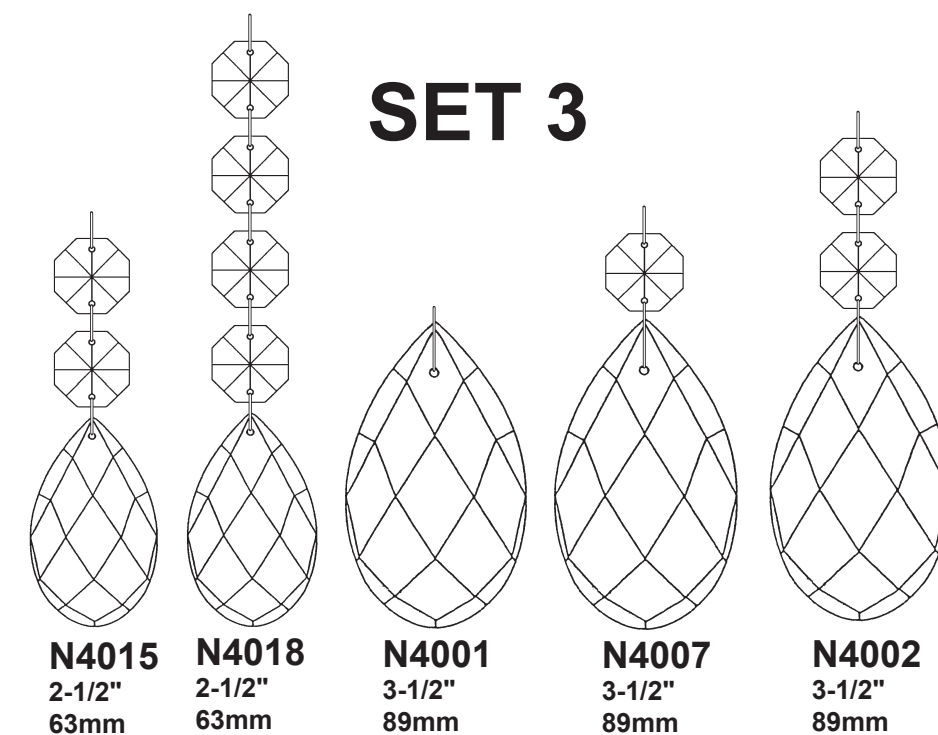

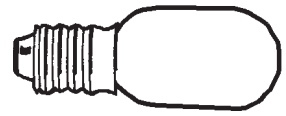

You will need 1 - T7
15 Watts Max
(Center Light)

21

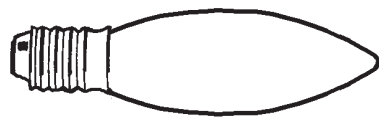

You will need 9 - B10
25 Watts Recommended
60 Watts Max

Install bulbs and be sure
to test fixture BEFORE
trimming.

Crystal Set 2 in Black

Crystal Set 1 in Black

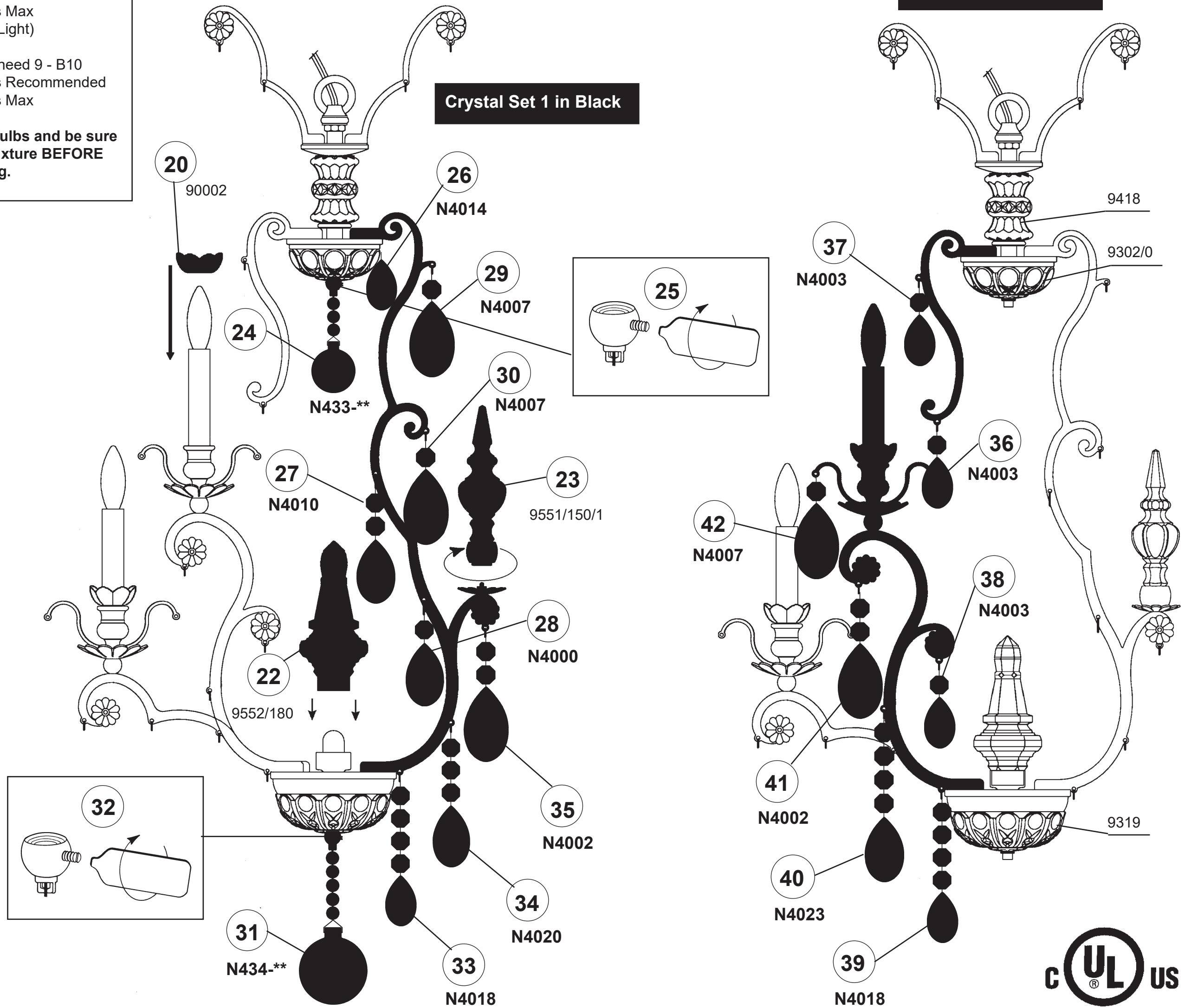

RENAISSANCE 3780- _____

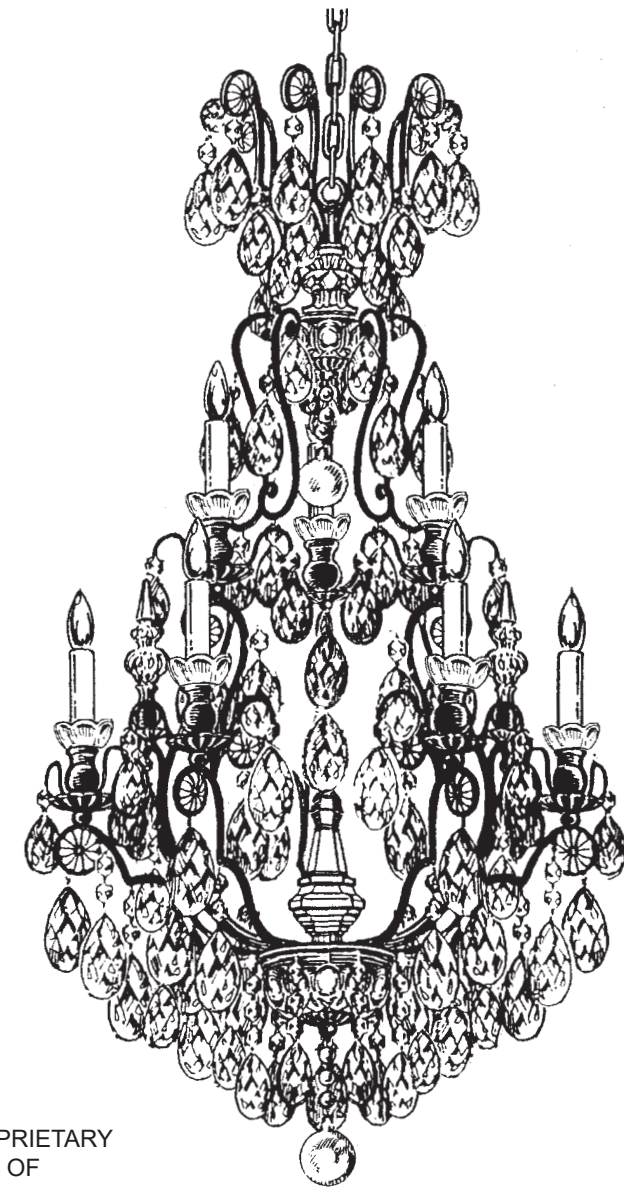











9 + 1 Lights
Diameter: 21"
Body Length: 40"
Hanging Weight: 38 lbs.

THIS DESIGN IS THE PROPRIETARY
TRADE DRESS/TRADEMARK OF
W SCHONBEK LLC.

 **SCHONBEK** | 1870

 **SCHONBEK** | 1870

								
MAX 60 W	MAX 15 W	110-120 V						

All electrical components must be installed by a licensed electrician in accordance with the National Electric Code and the appropriate local electrical codes.

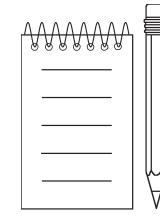
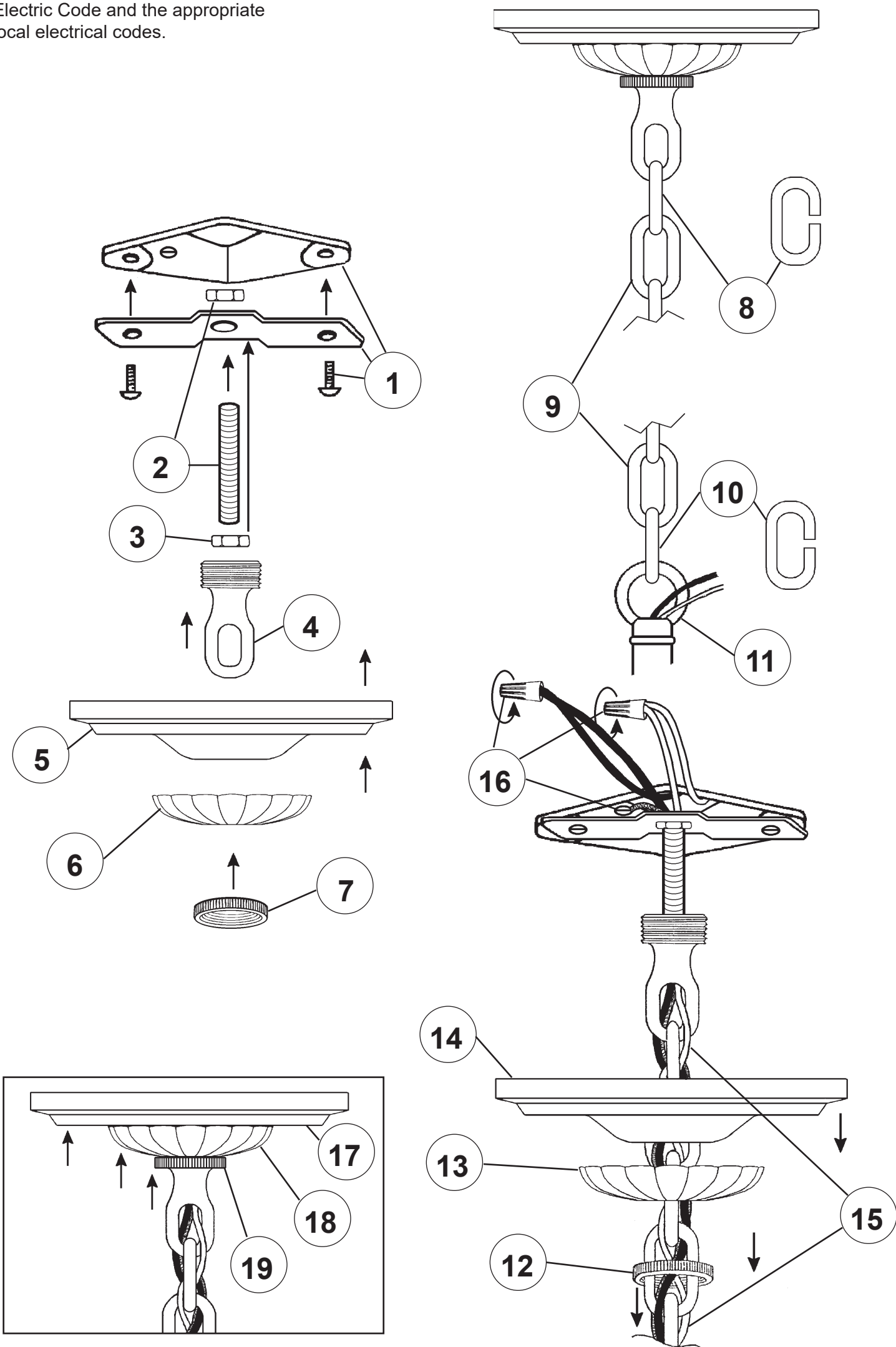

Crystal Set 3 in Black

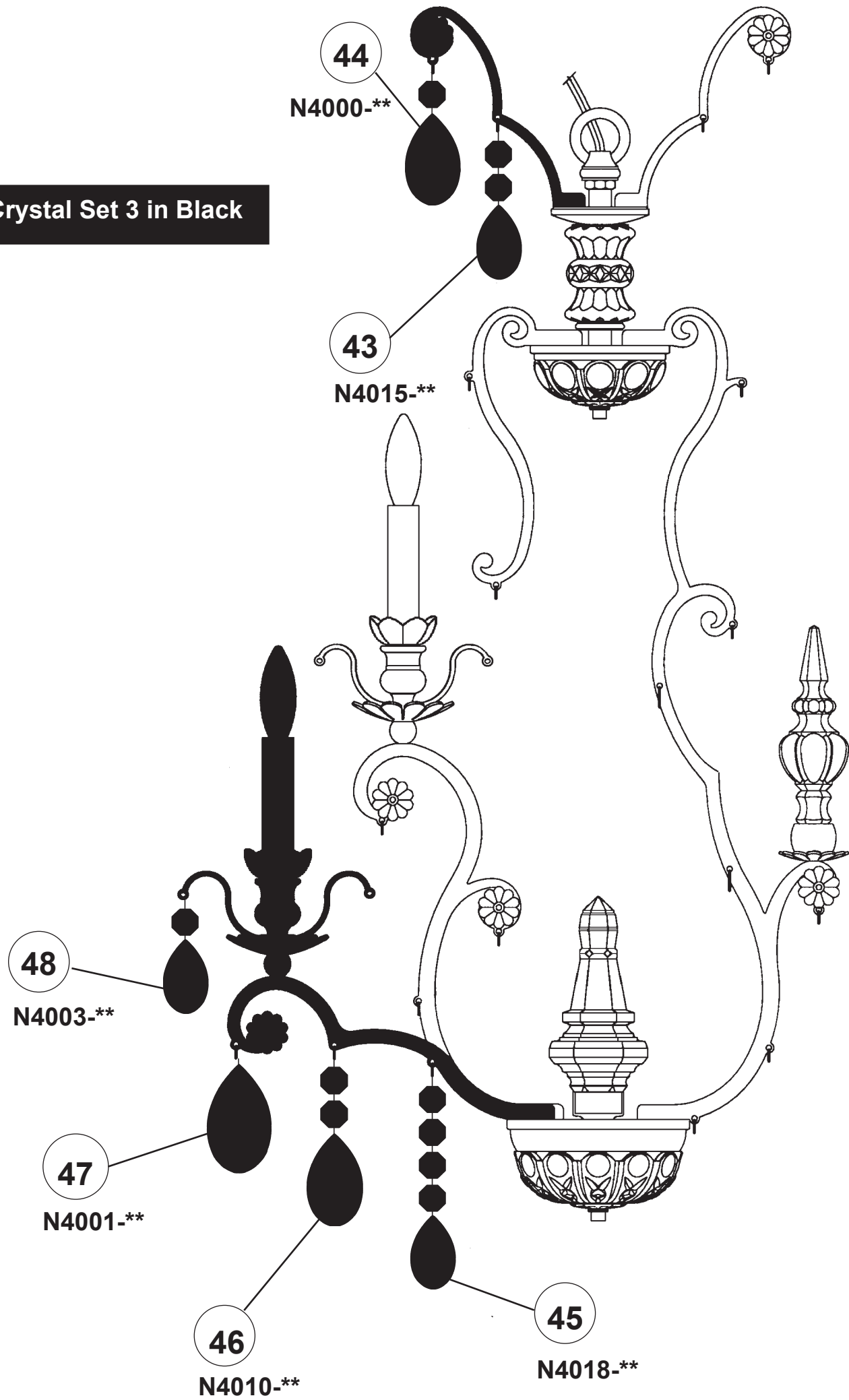

SET 1

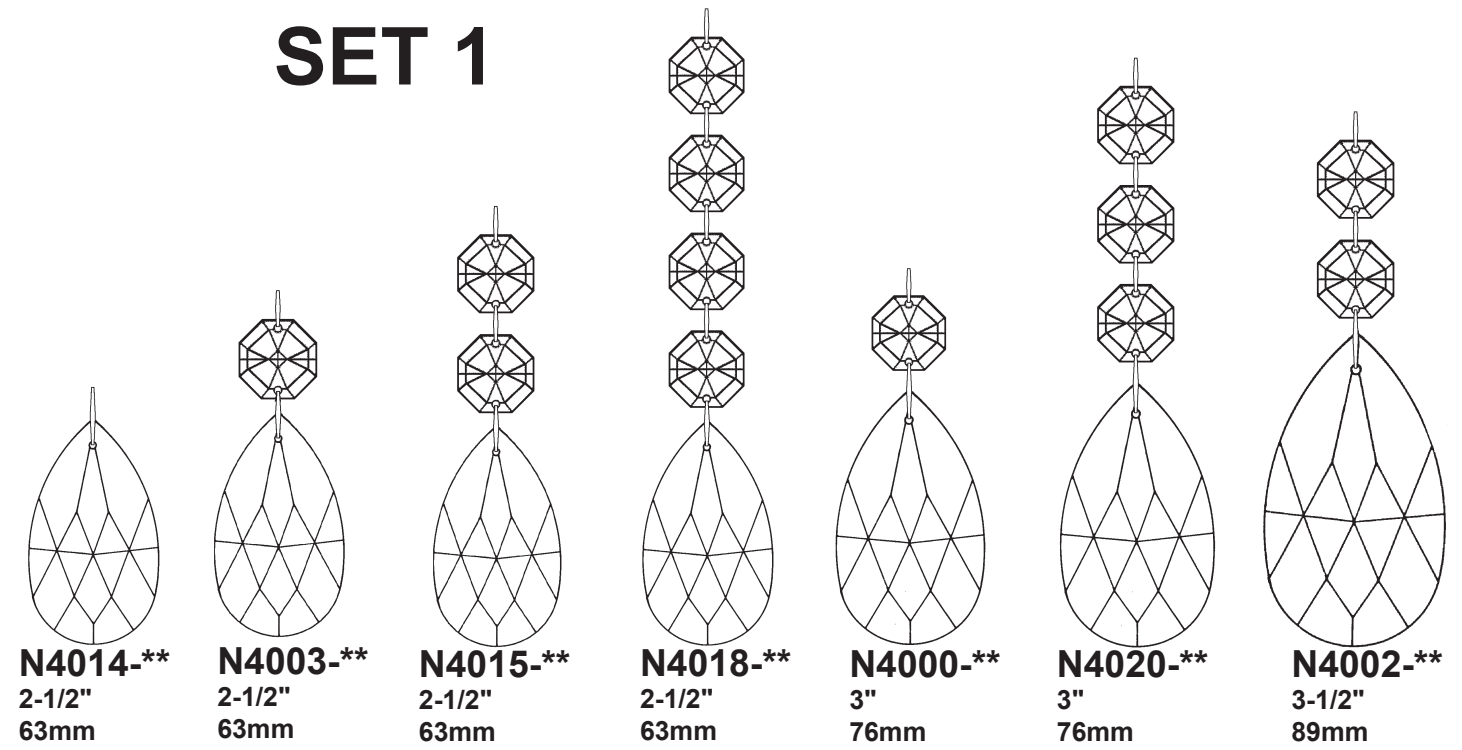

SET 2

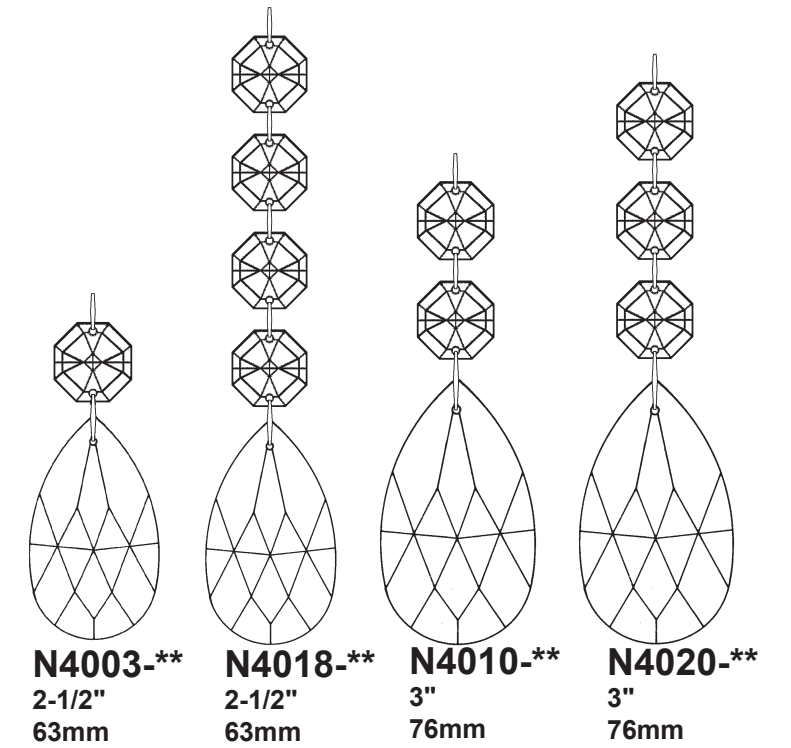

SET 3

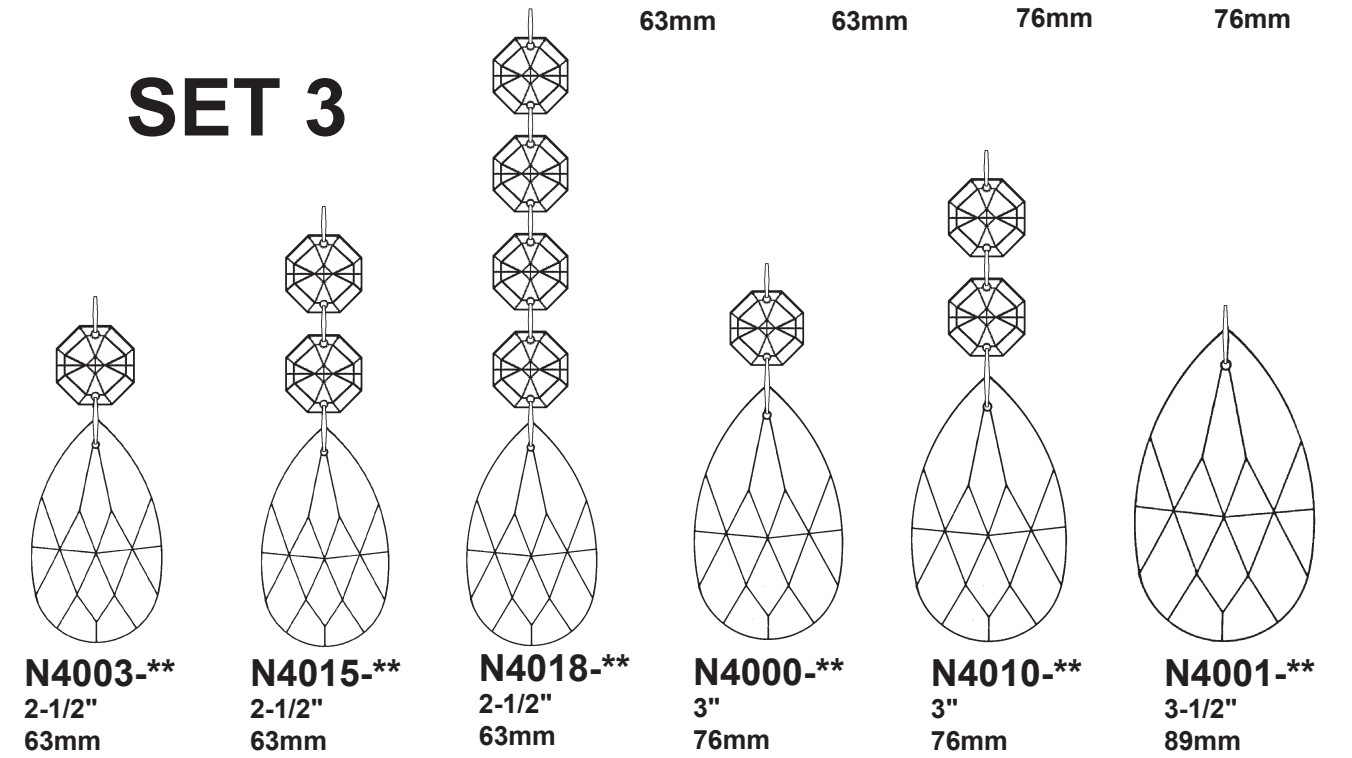

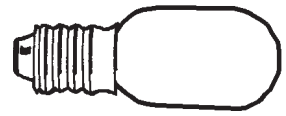

You will need 1 - T7
15 Watts Max
(Center Light)

21



You will need 9 - B10
25 Watts Recommended
60 Watts Max

Install bulbs and be sure
to test fixture BEFORE
trimming.

Crystal Set 2 in Black

Crystal Set 1 in Black

