

RENAISSANCE 3785- ____

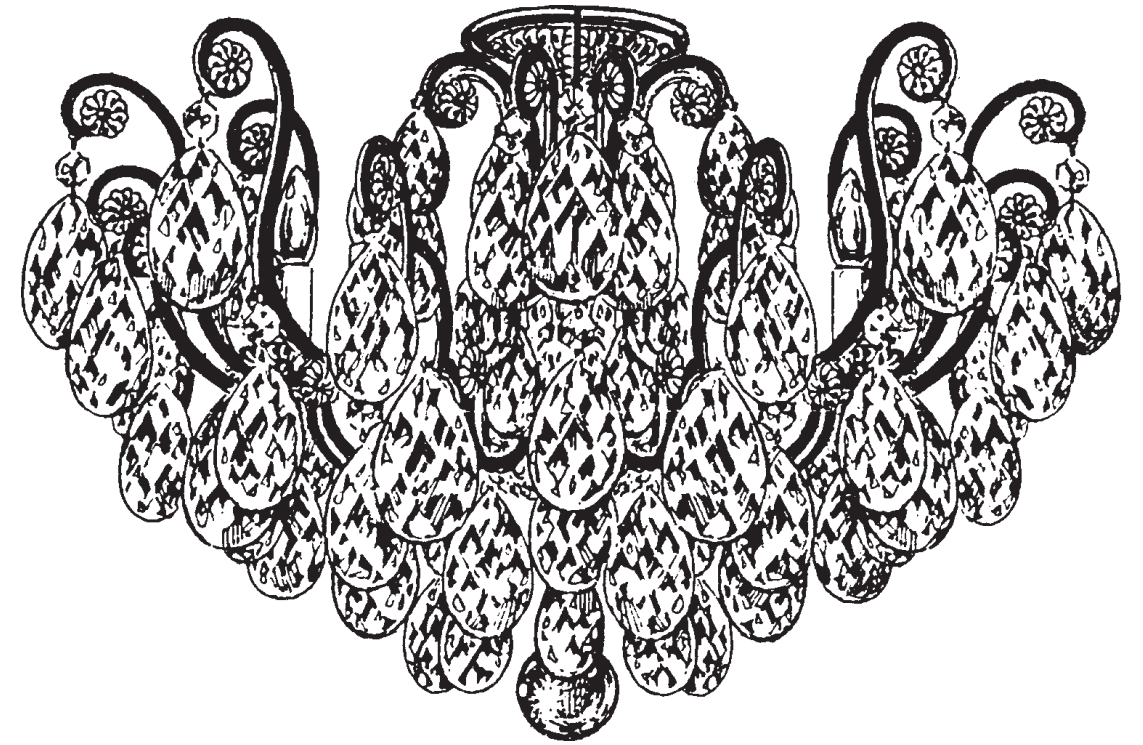











8 Lights
Diameter: 26"
Body Length: 18"
Hanging Weight: 30 lbs.

THIS DESIGN IS THE PROPRIETARY
TRADE DRESS/TRADEMARK OF
W SCHONBEK LLC.

 **SCHONBEK** | 1870

 **SCHONBEK** | 1870

								
MAX 40 W	110-120 V							

All electrical components must be installed by a licensed electrician in accordance with the National Electric Code and the appropriate local electrical codes.

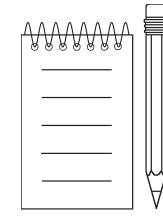
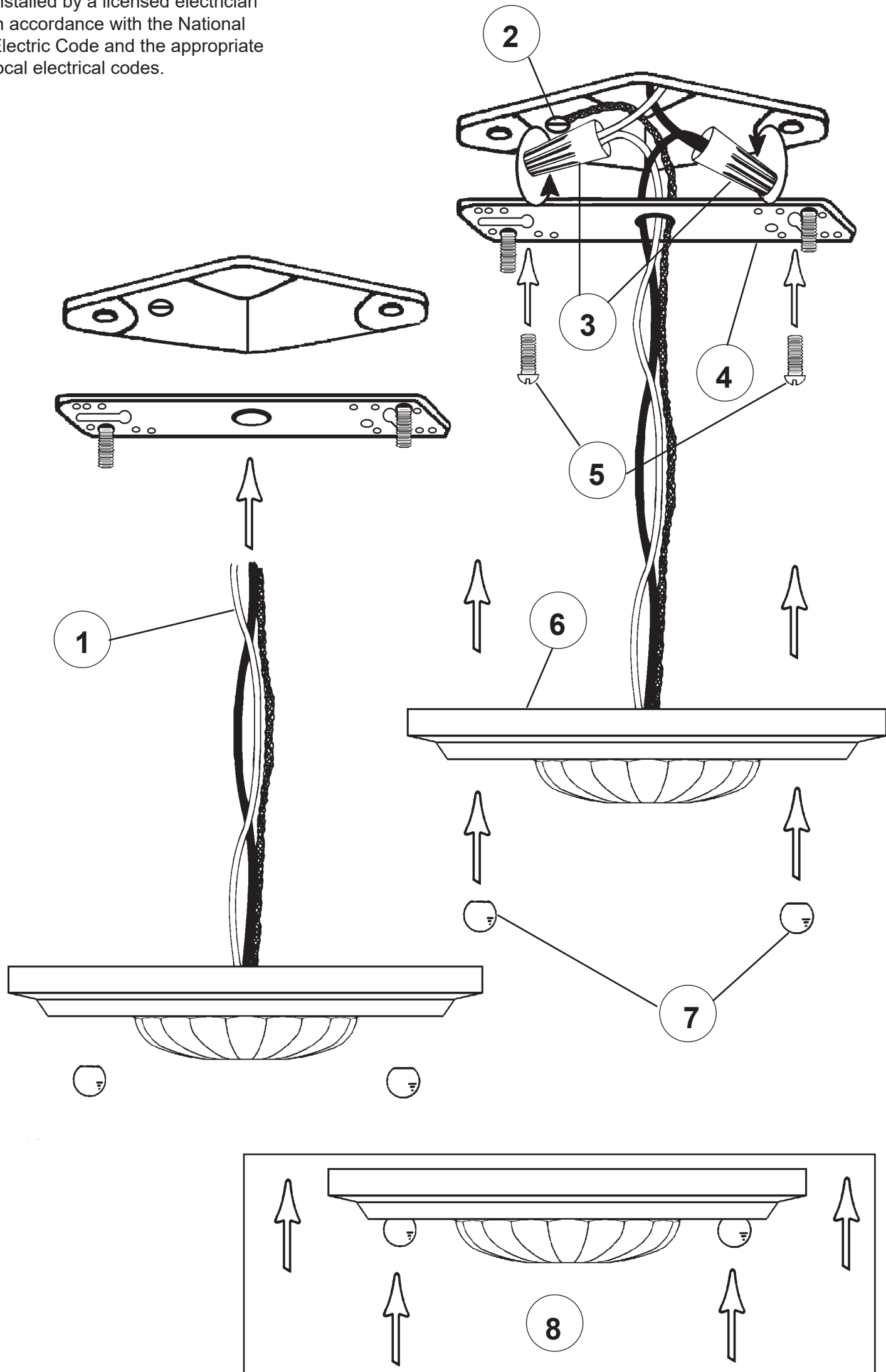

Crystal Set 3 in Black

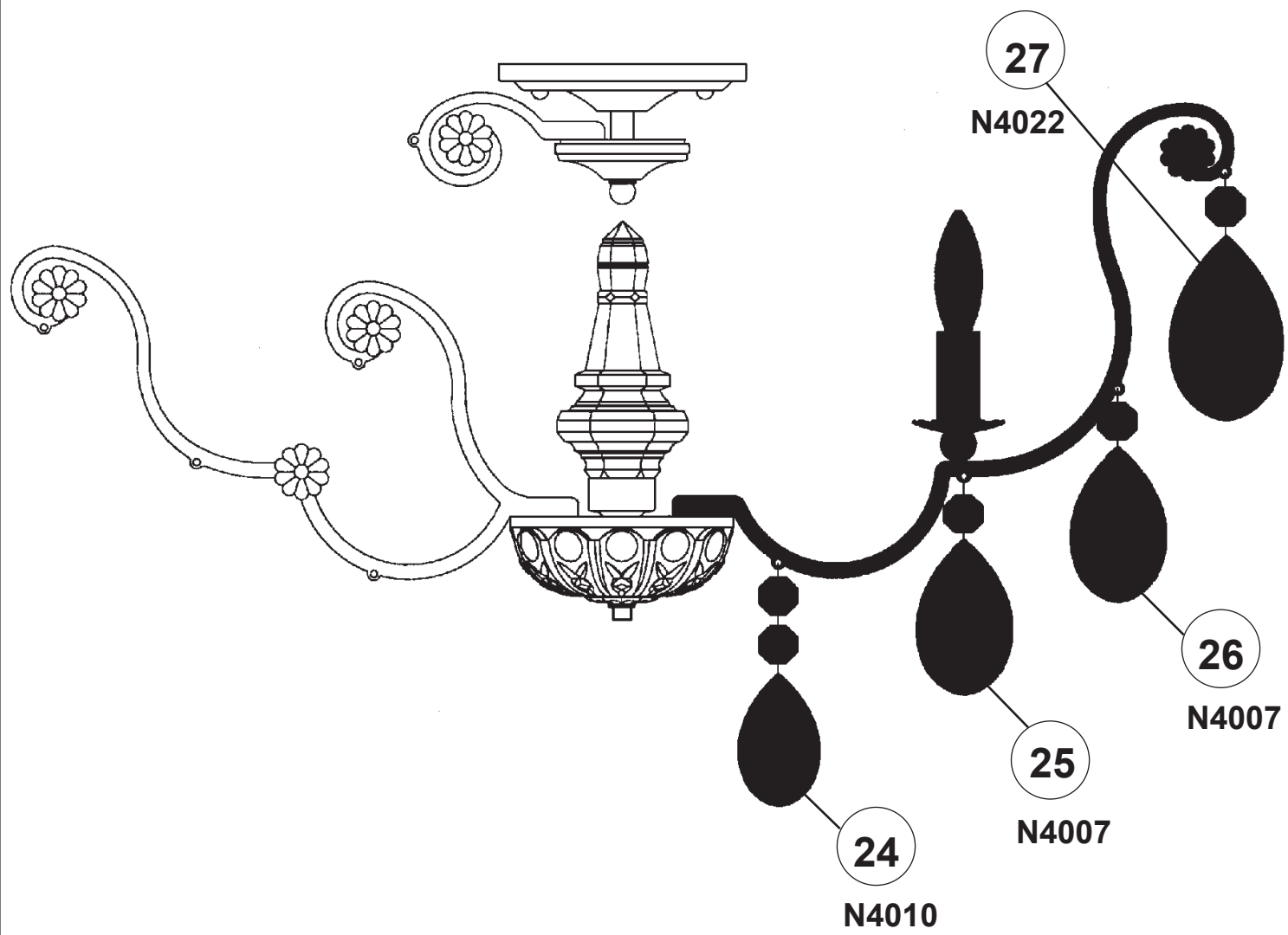

SET 1

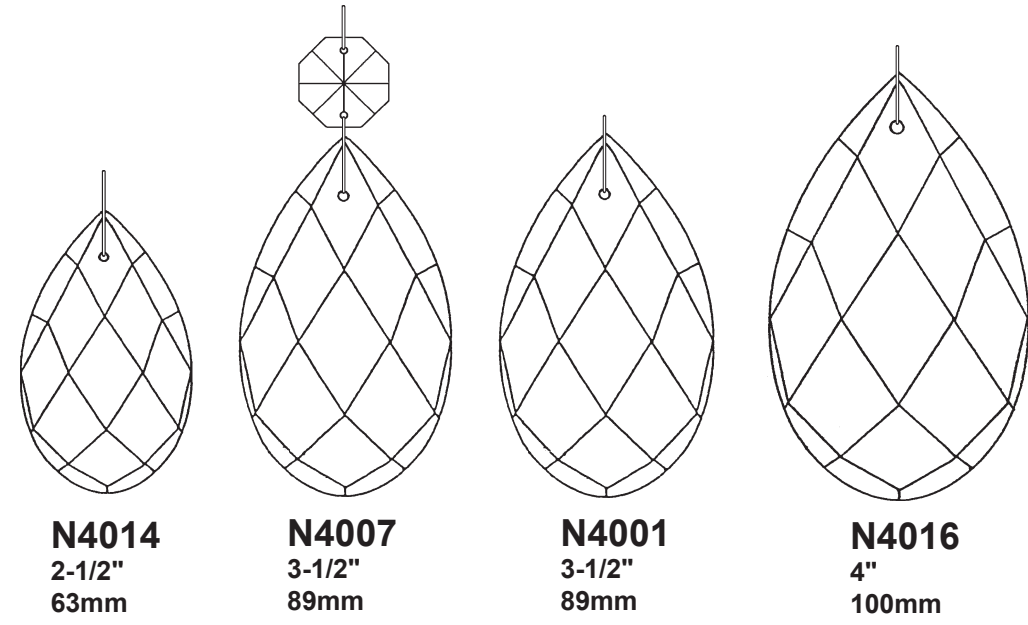

SET 2

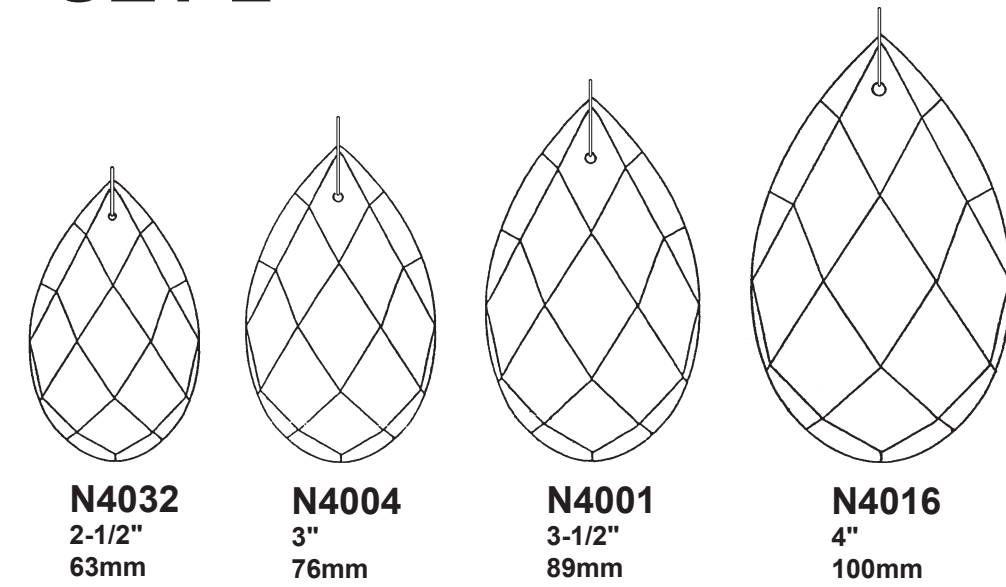

SET 3

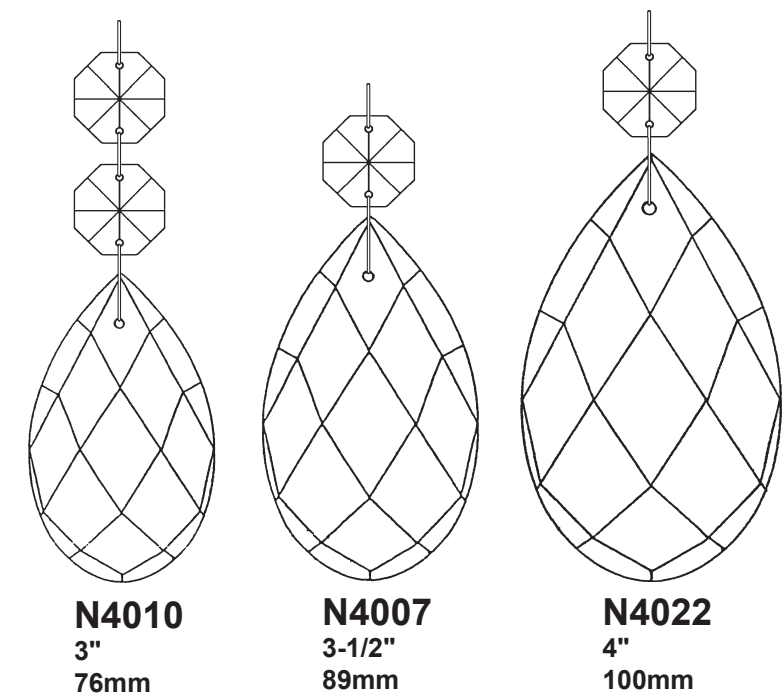

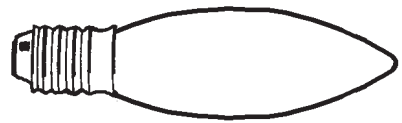

9 8 - B10
40 Watts Max
25 Watts Recommend

Crystal Set 2 in Black

Crystal Set 1 in Black

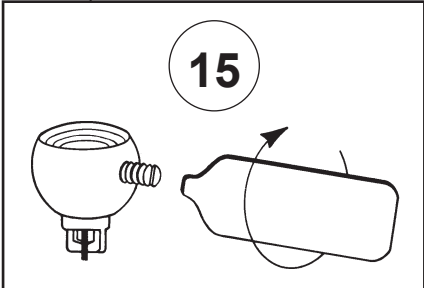
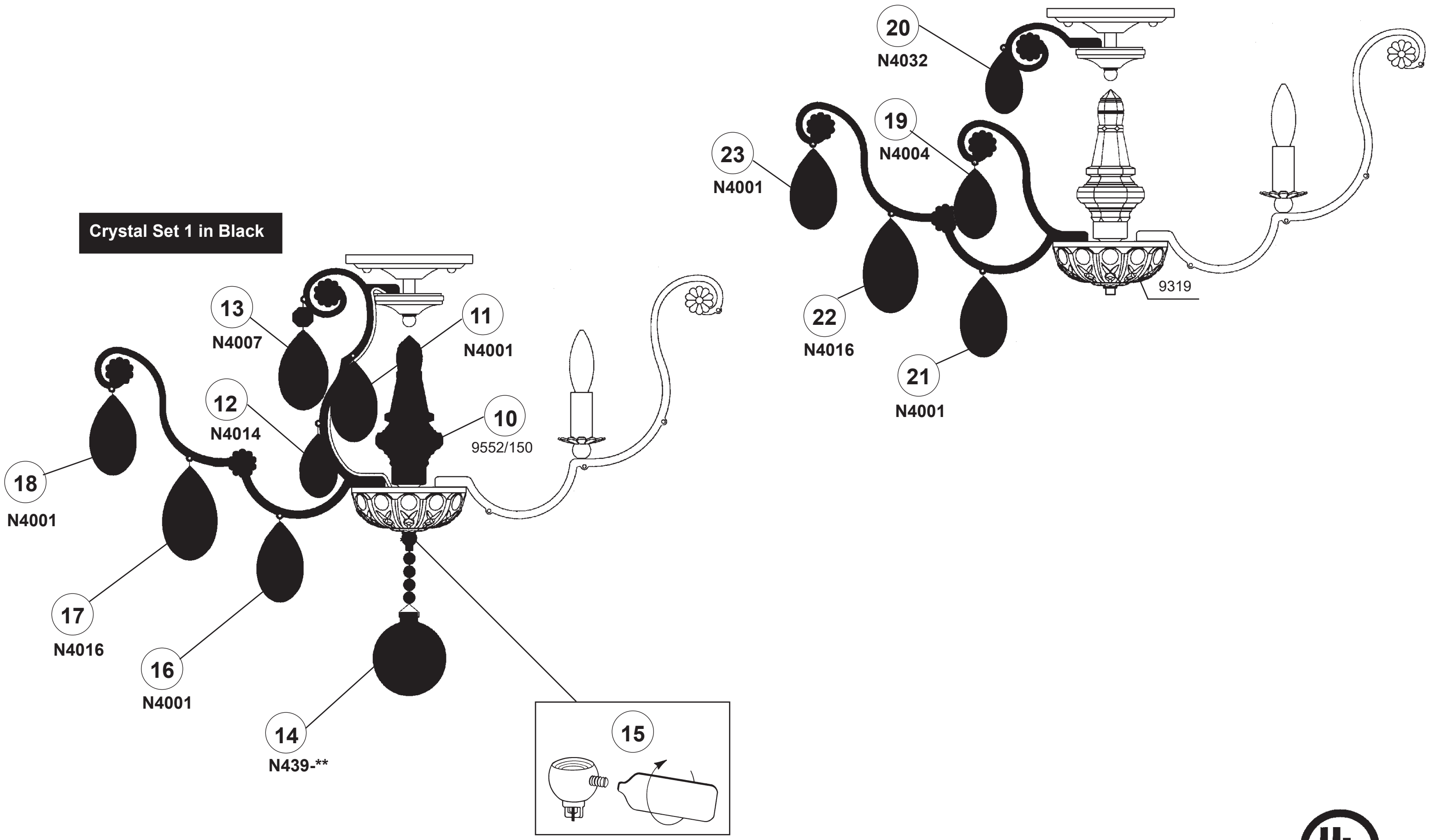

RENAISSANCE 3785- _____

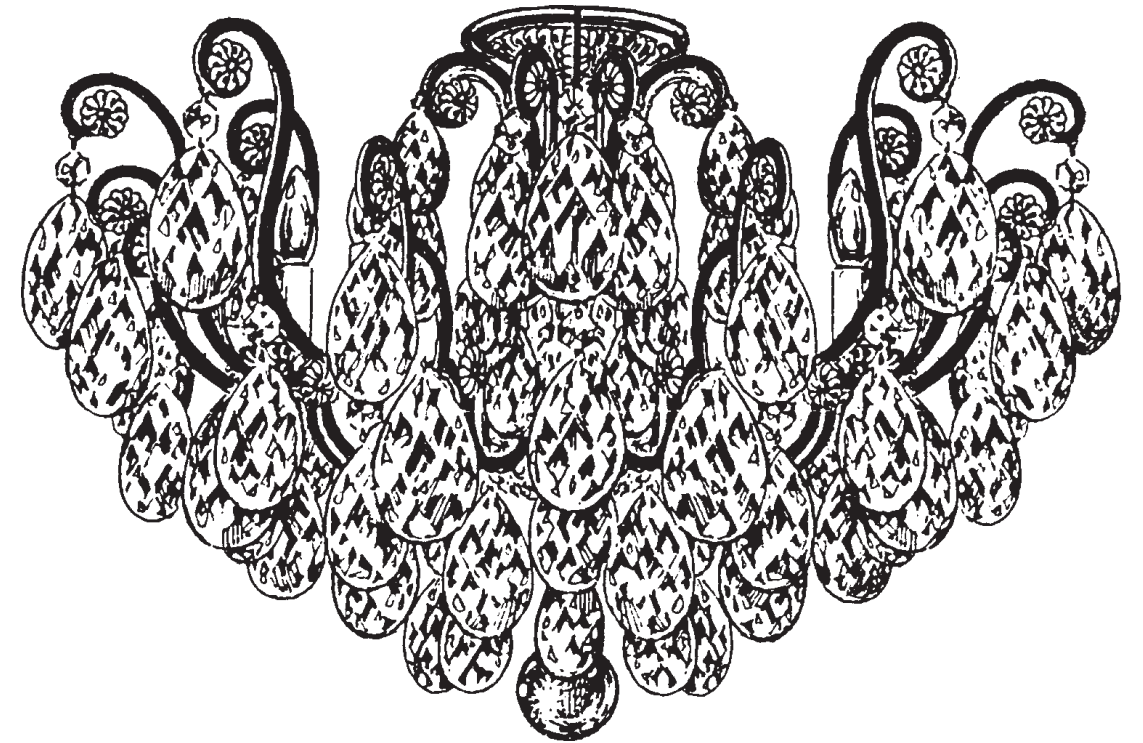











8 Lights
Diameter: 26"
Body Length: 18"
Hanging Weight: 30 lbs.

THIS DESIGN IS THE PROPRIETARY
TRADE DRESS/TRADEMARK OF
W SCHONBEK LLC.

 **SCHONBEK** | 1870

 **SCHONBEK** | 1870

								
MAX 40 W	110-120 V							

All electrical components must be installed by a licensed electrician in accordance with the National Electric Code and the appropriate local electrical codes.

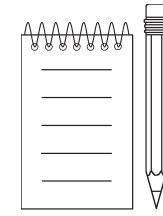
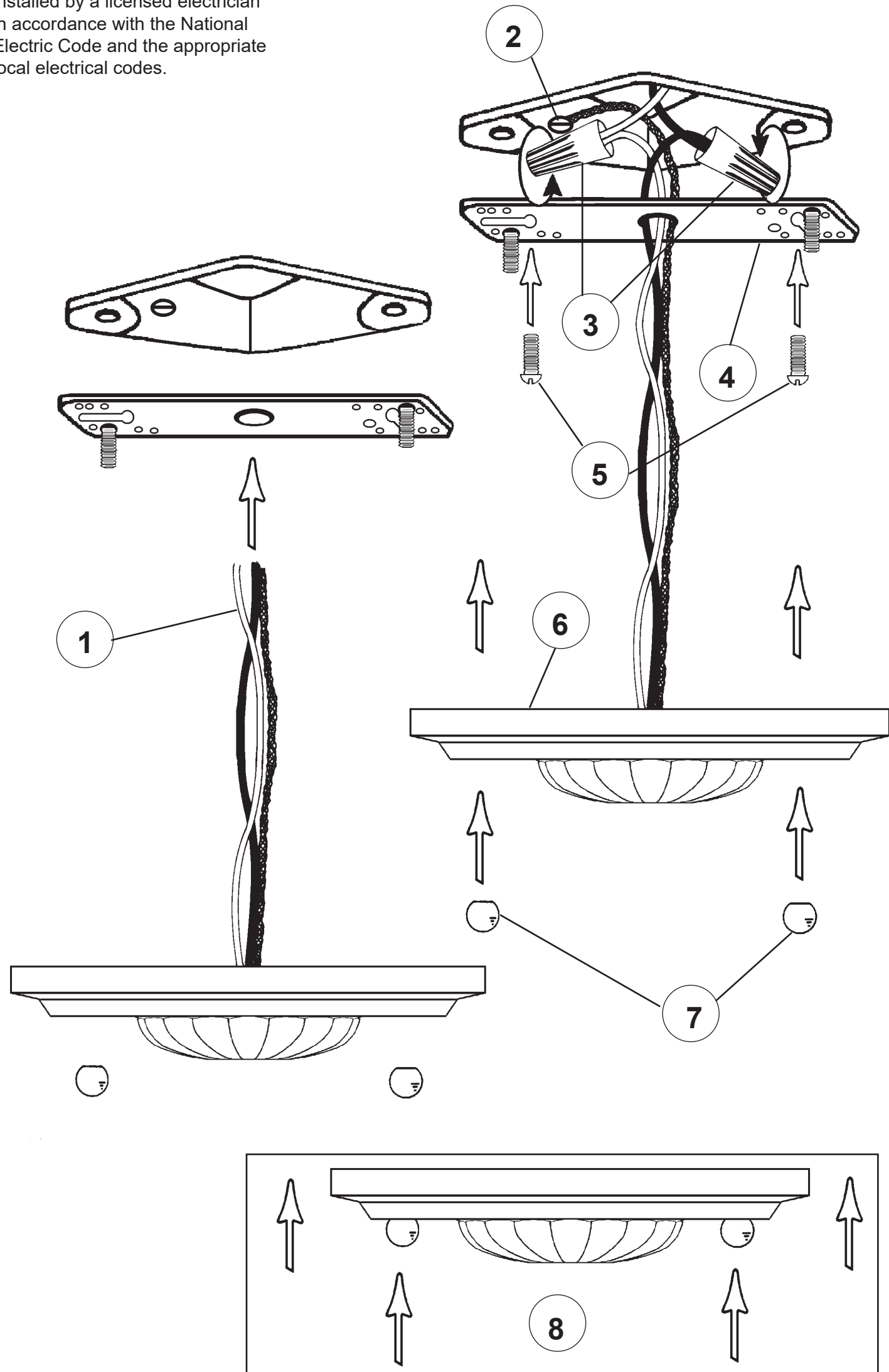

Crystal Set 3 in Black

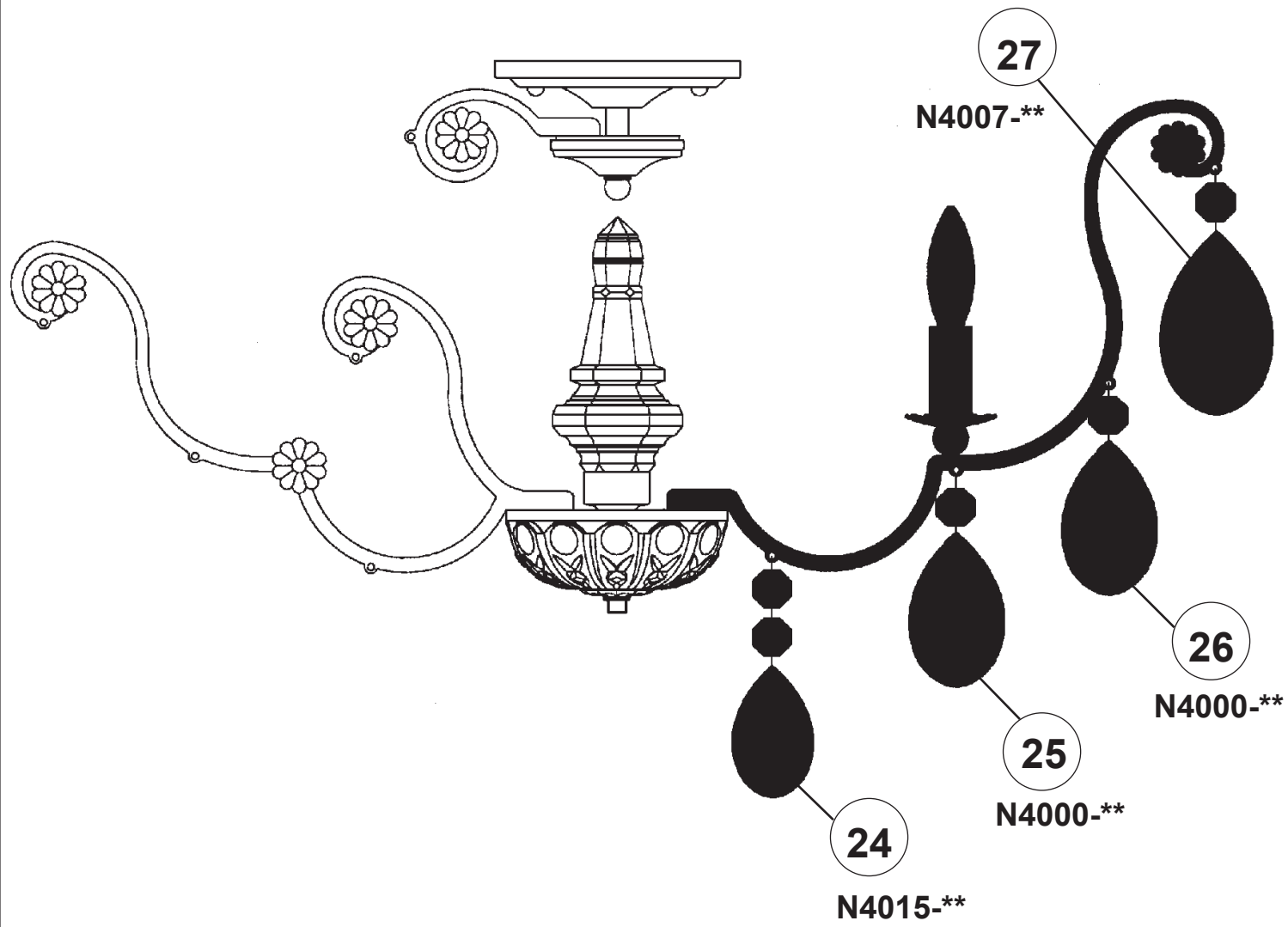

SET 1

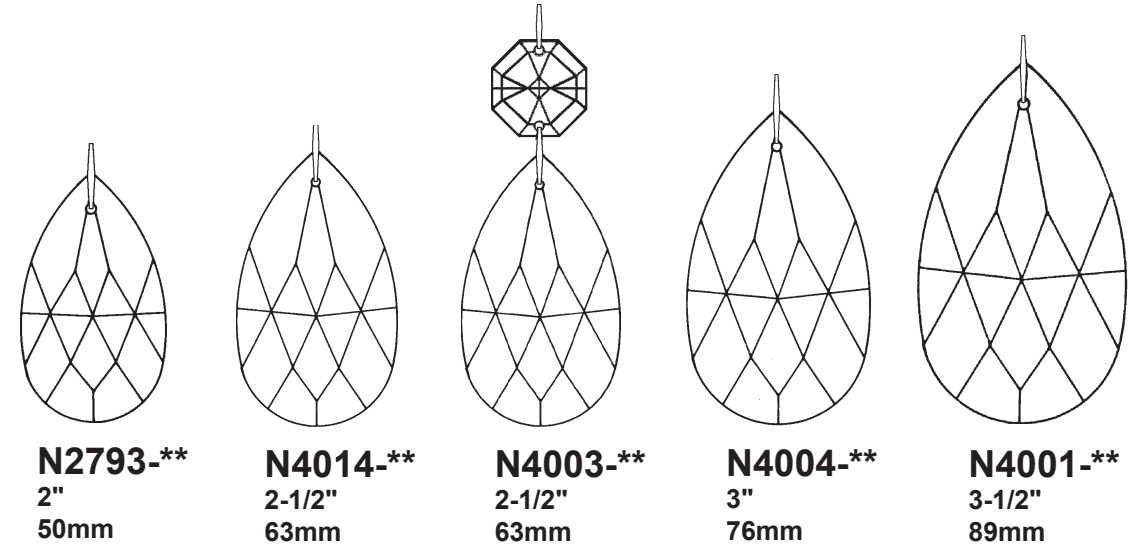

SET 2

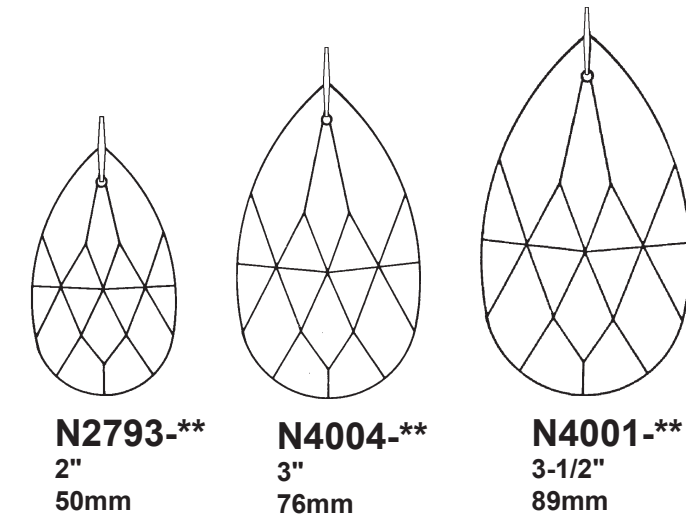

SET 3

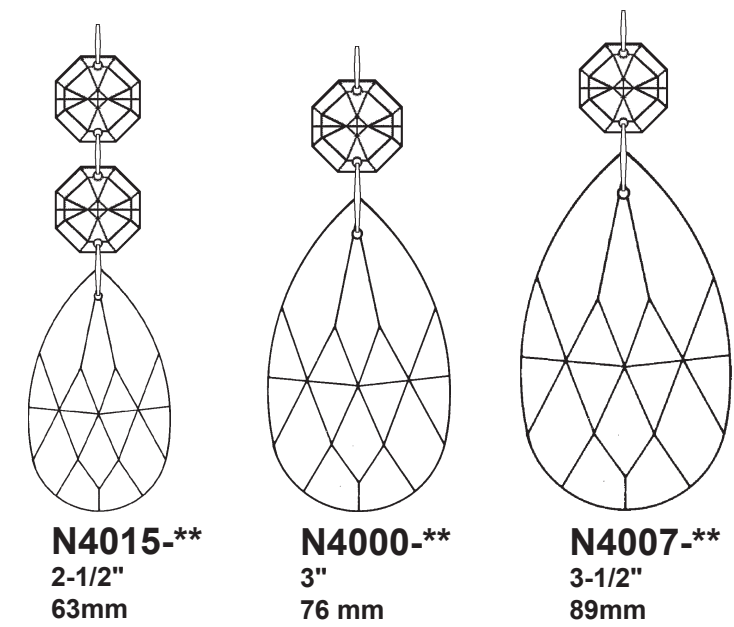

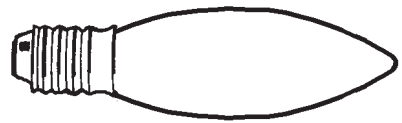

9 8 - B10
40 Watts Max
25 Watts Recommend

Crystal Set 2 in Black

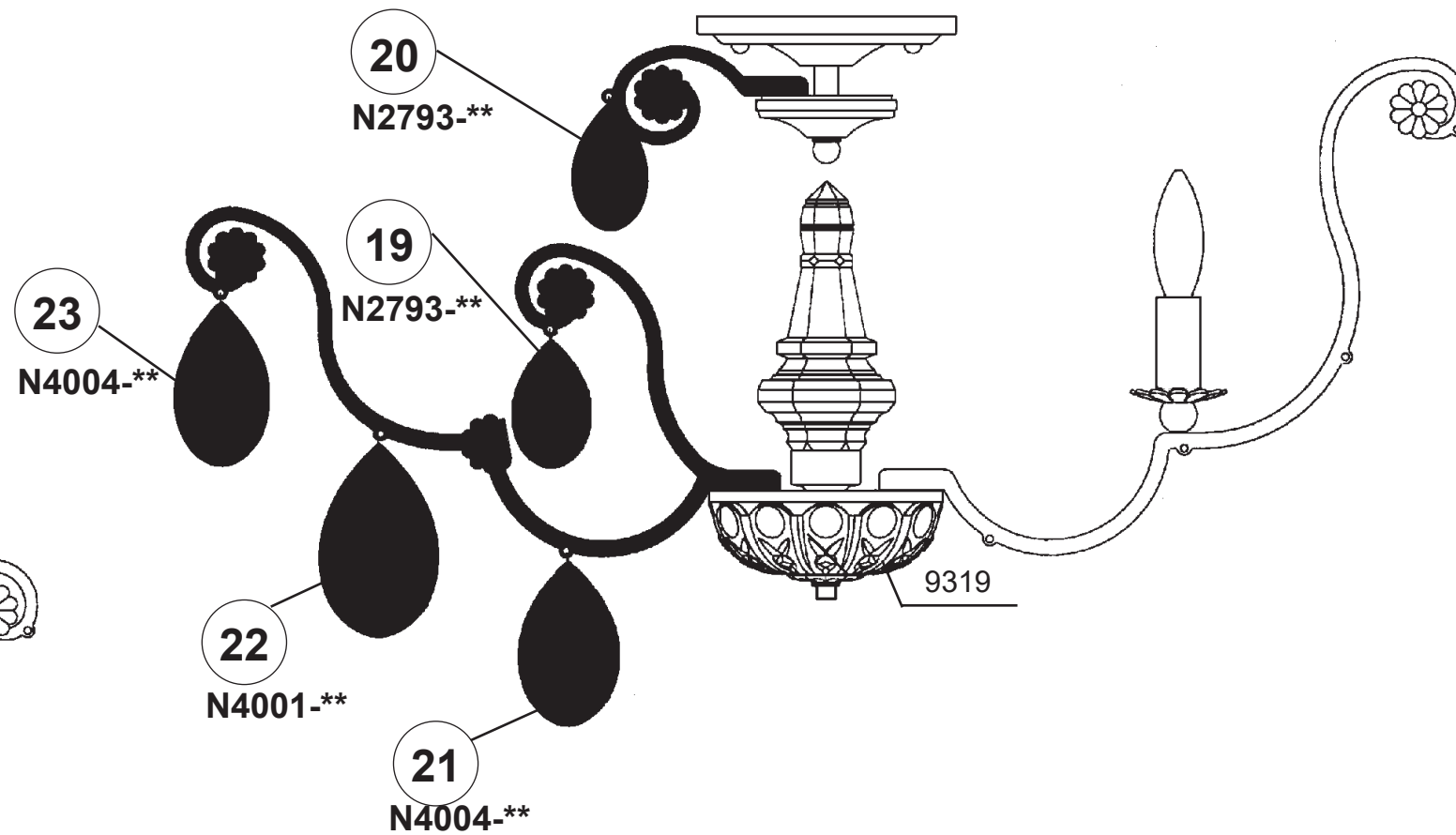

Crystal Set 1 in Black

