

# RENAISSANCE 3787- \_\_\_\_

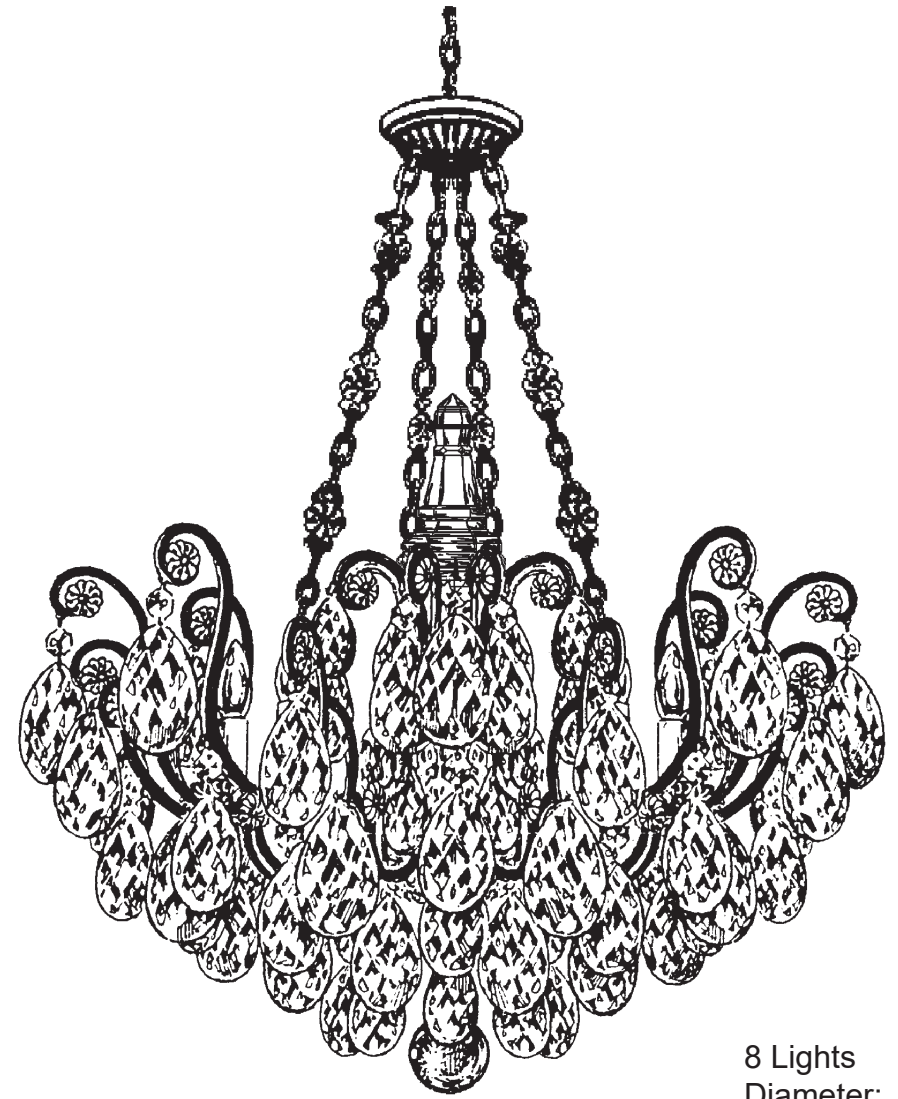











8 Lights  
Diameter: 26-1/2"  
Body Length: 35"  
Hanging Weight: 37 lbs.

**T**HIS DESIGN IS THE PROPRIETARY  
TRADE DRESS/TRADEMARK OF  
W SCHONBEK LLC.

 **SCHONBEK** | 1870

 **SCHONBEK** | 1870

									
MAX <b>60</b> W		110-120 V							

All electrical components must be installed by a licensed electrician in accordance with the National Electric Code and the appropriate local electrical codes.

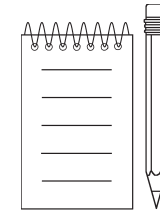
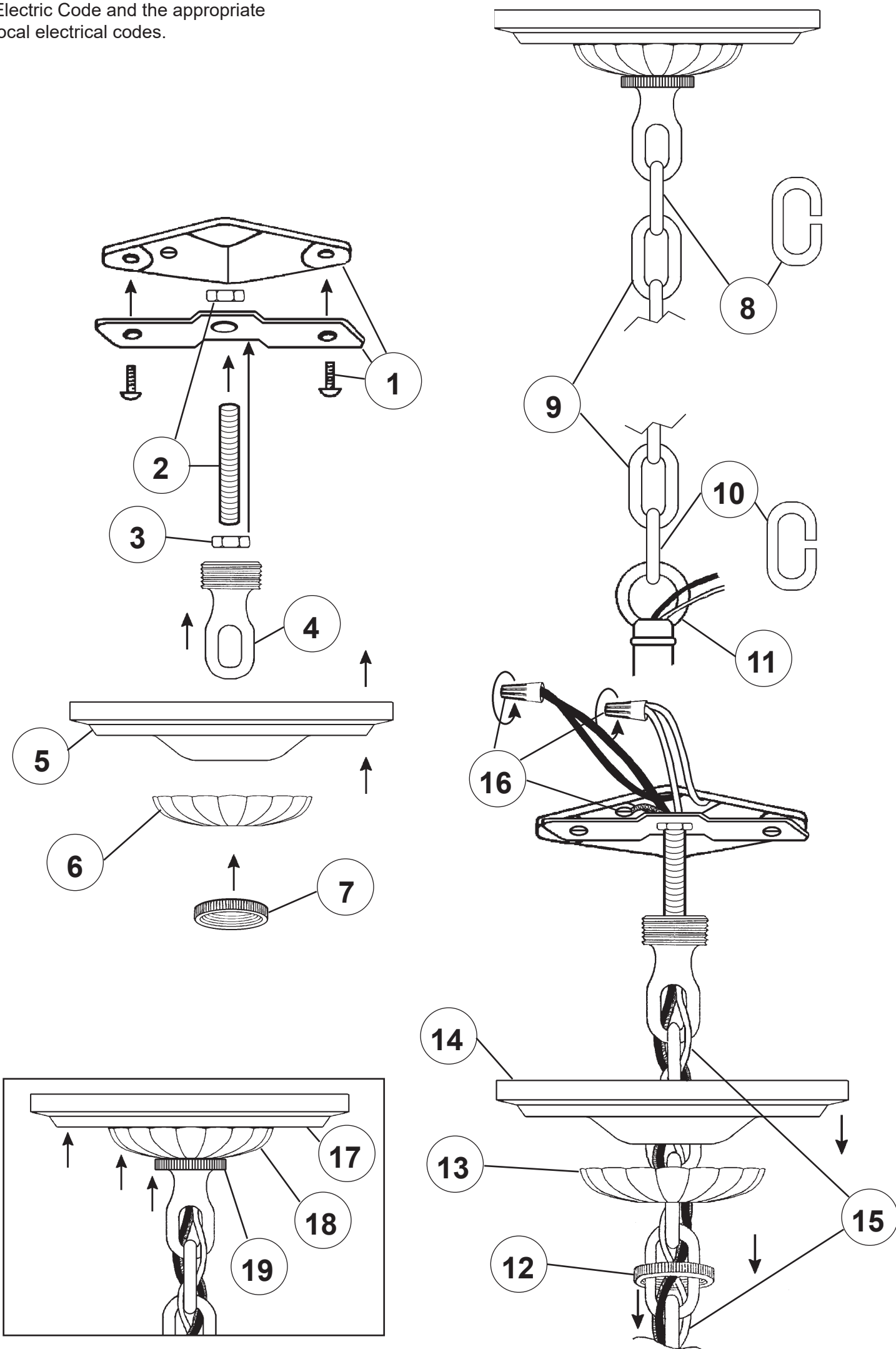

**Crystal Set 3 in Black**

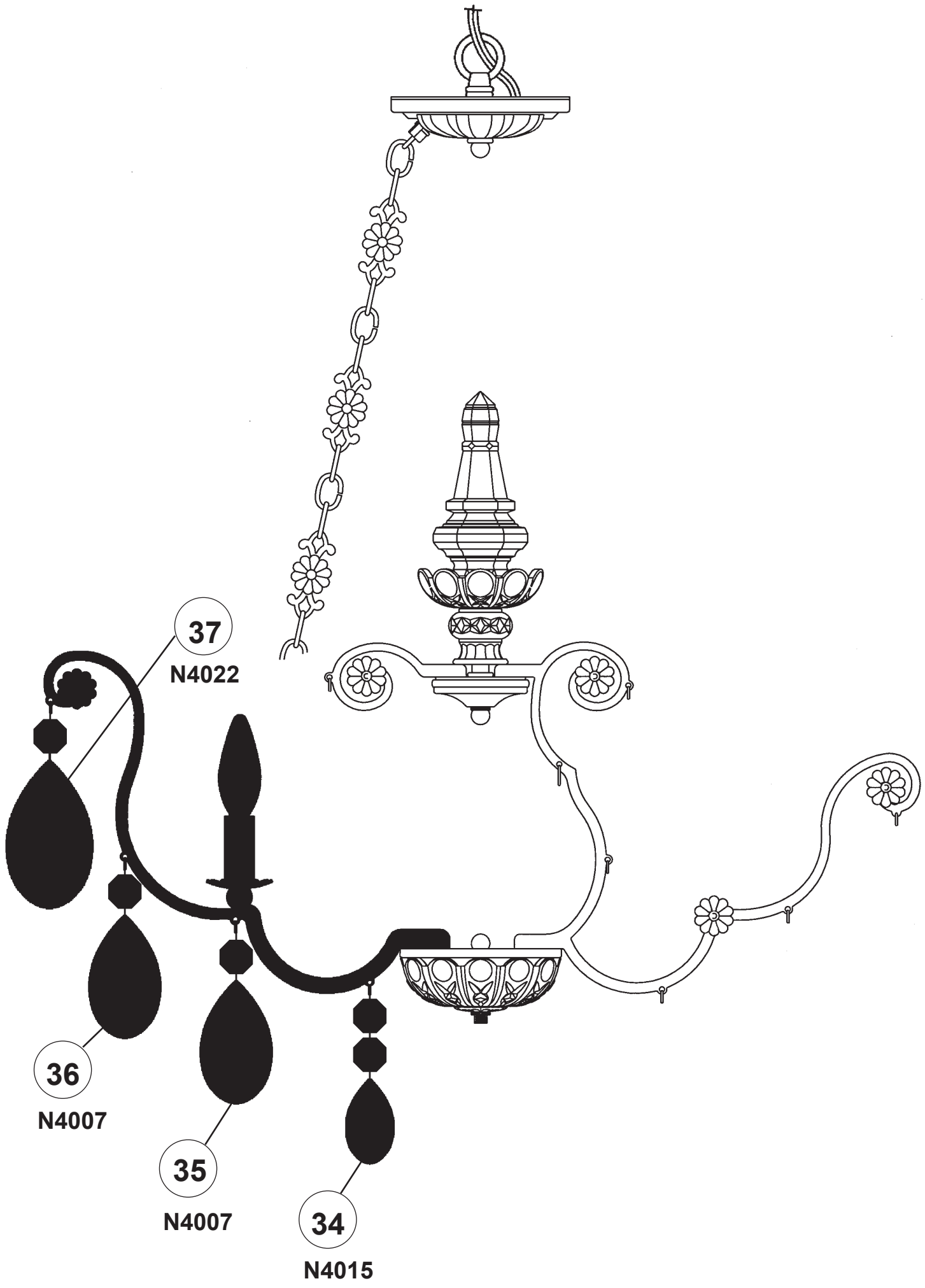

37  
N4022

36  
N4007

35  
N4007

34  
N4015

**SET 1**

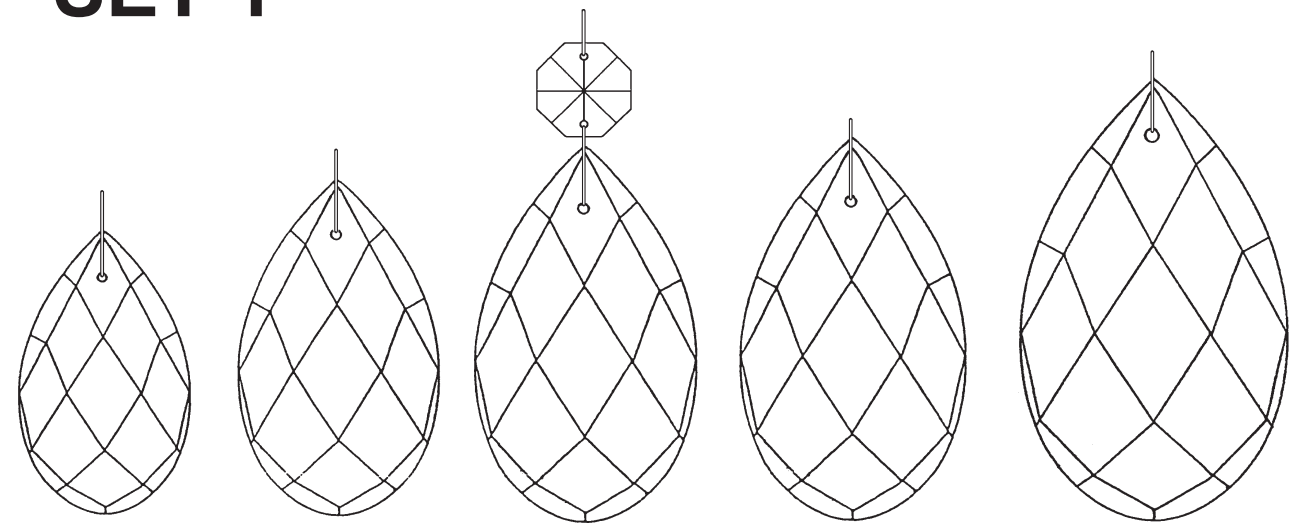

<b>N4014</b> 2-1/2" 63mm	<b>N4004</b> 3" 76mm	<b>N4007</b> 3-1/2" 89mm	<b>N4001</b> 3-1/2" 89mm	<b>N4016</b> 4" 100mm
--------------------------------	----------------------------	--------------------------------	--------------------------------	-----------------------------

**SET 2**

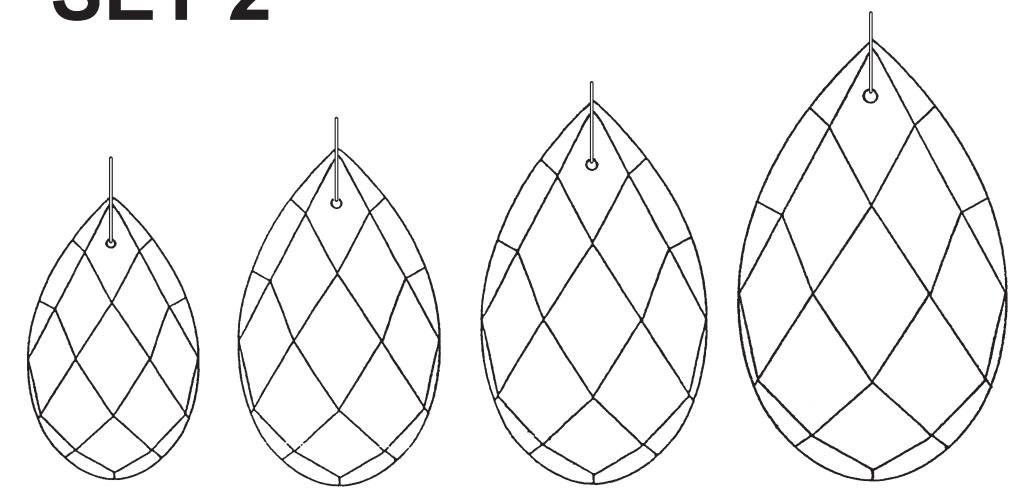

<b>N4014</b> 2-1/2" 63mm	<b>N4004</b> 3" 76mm	<b>N4001</b> 3-1/2" 89mm	<b>N4016</b> 4" 100mm
--------------------------------	----------------------------	--------------------------------	-----------------------------

**SET 3**

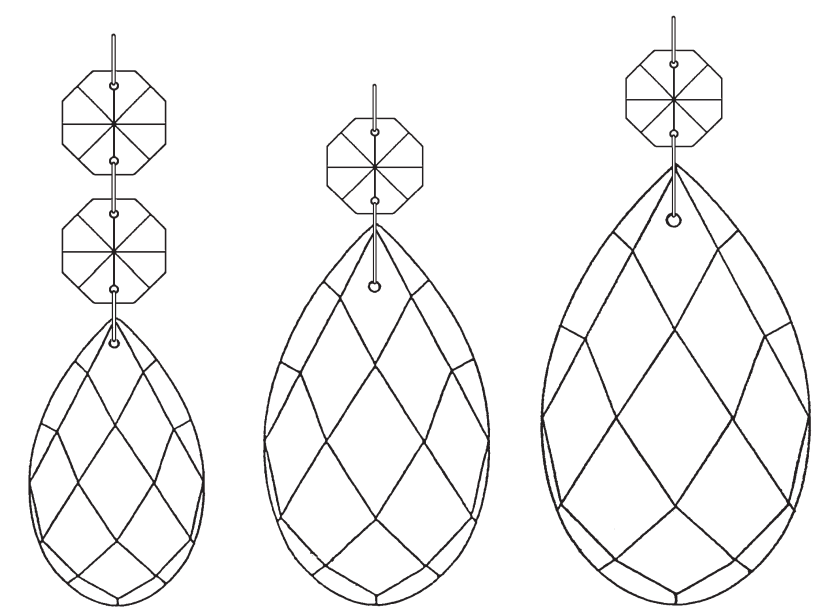

<b>N4015</b> 2-1/2" 63mm	<b>N4007</b> 3-1/2" 89mm	<b>N4022</b> 4" 100mm
--------------------------------	--------------------------------	-----------------------------

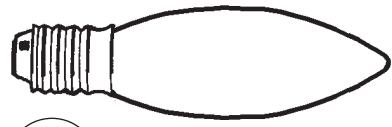

20

You will need 8 - B10  
25 Watts Recommended  
60 Watts Max

Install bulb and be sure  
to test fixture **BEFORE**  
trimming.

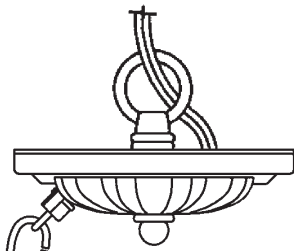

**Crystal Set 1 in Black**



21

9552/150

22  
N4001

24

N4007

23

N4014

29

N4016

27

N4004

28

N4001

25

N439-\*\*

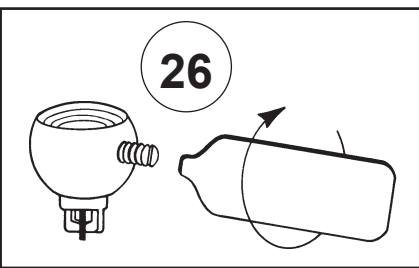

26

**Crystal Set 2 in Black**

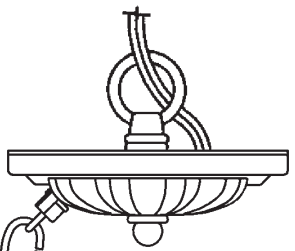

9302

9419

30

N4014

9319

33

N4016

32

N4001

31

N4004



# RENAISSANCE 3787- \_\_\_\_\_













8 Lights  
Diameter: 26-1/2"  
Body Length: 35"  
Hanging Weight: 37 lbs.

**T**HIS DESIGN IS THE PROPRIETARY  
TRADE DRESS/TRADEMARK OF  
W SCHONBEK LLC.

 **SCHONBEK** | 1870

 **SCHONBEK** | 1870

								
MAX <b>60</b> W		110-120 V						

All electrical components must be installed by a licensed electrician in accordance with the National Electric Code and the appropriate local electrical codes.

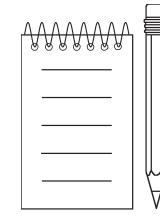
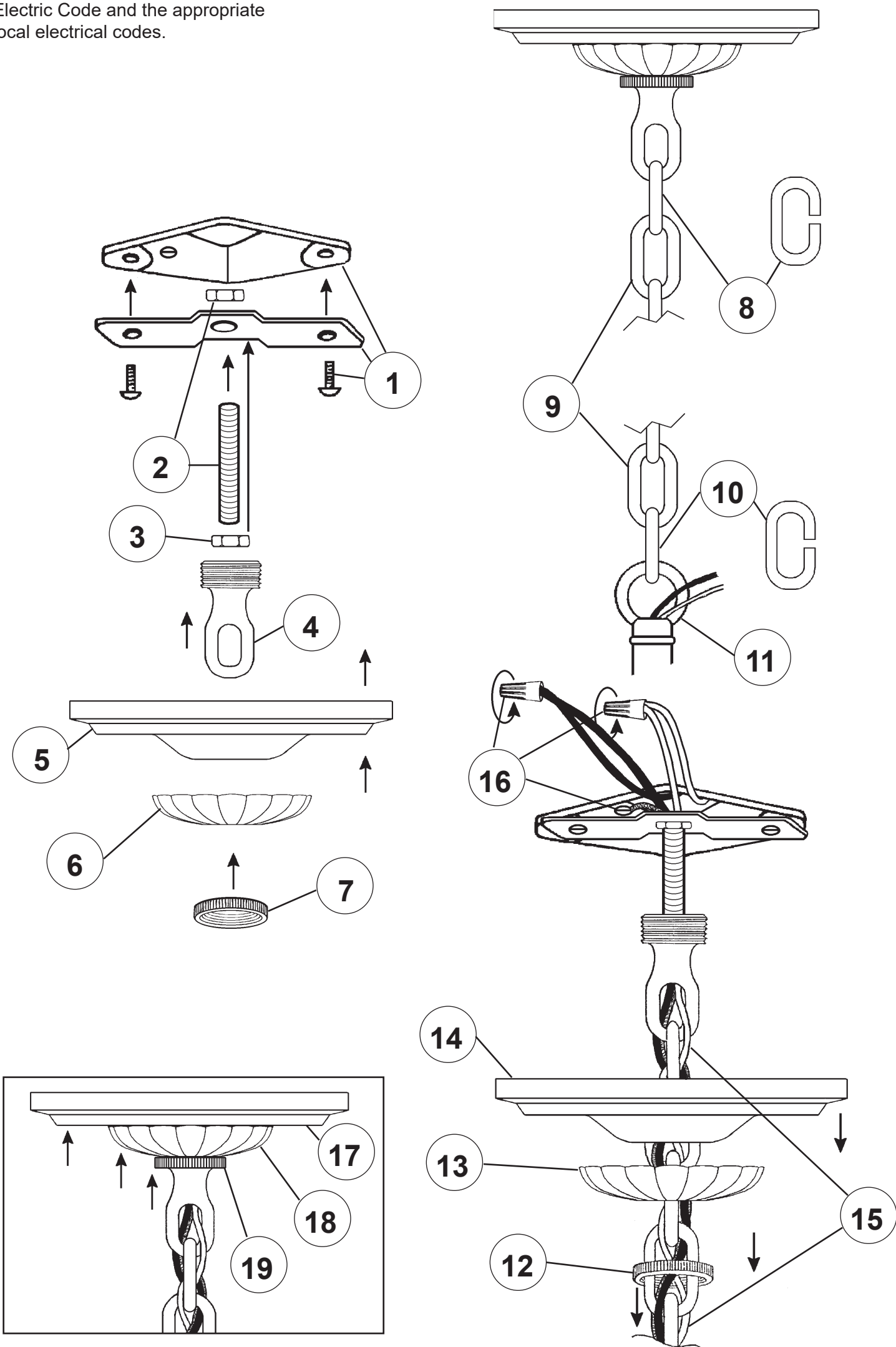



**Crystal Set 3 in Black**

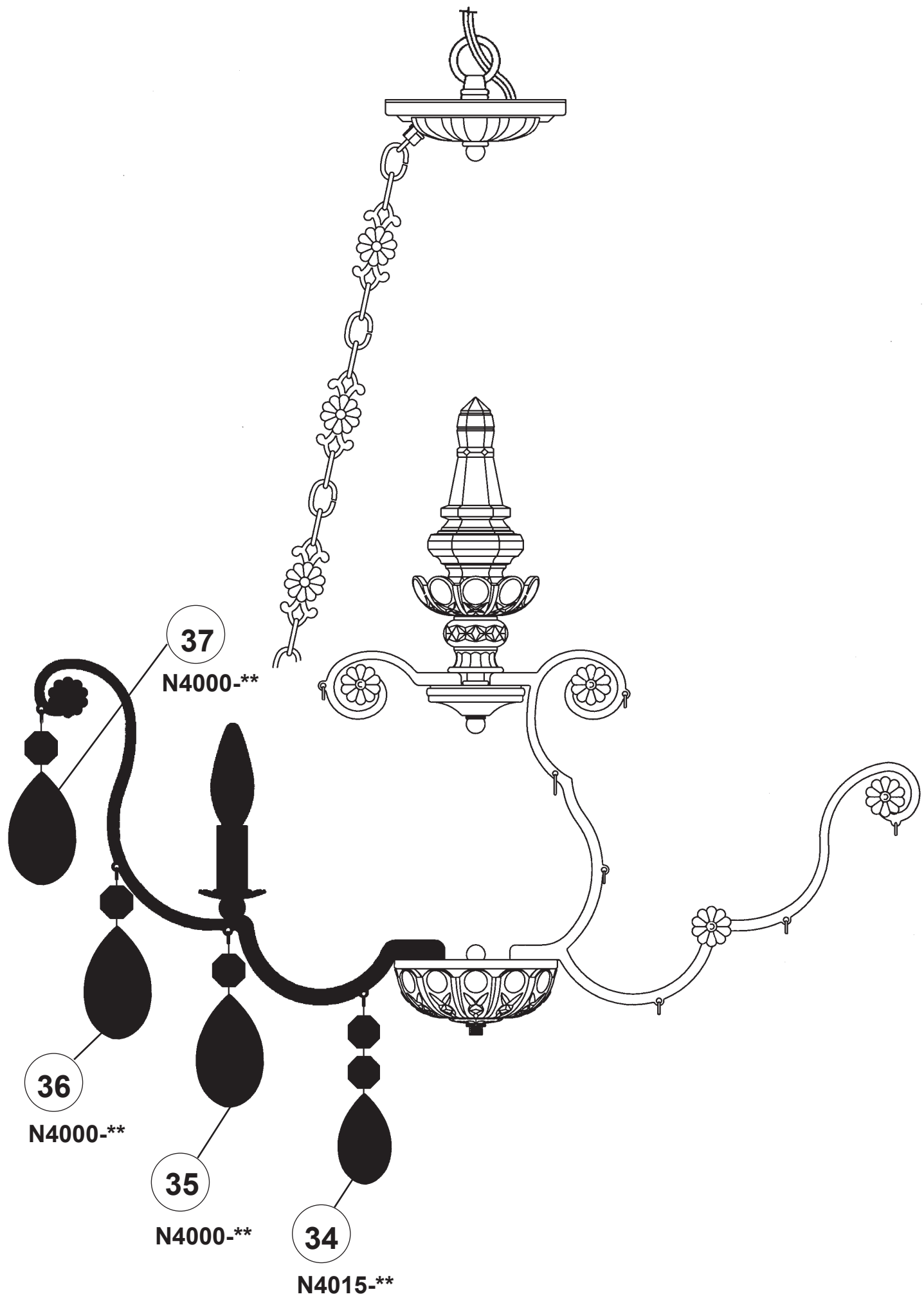

**SET 1**

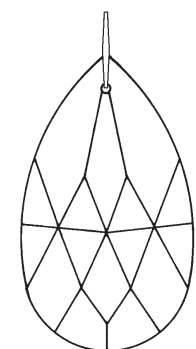

**N4014-\*\***  
2-1/2"  
63mm

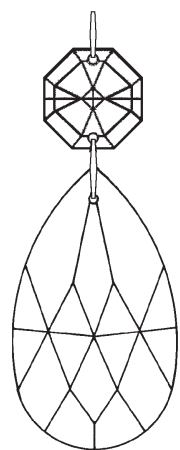

**N4003-\*\***  
2-1/2"  
63mm

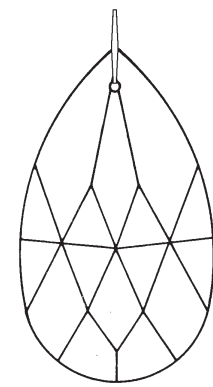

**N4004-\*\***  
3"  
76mm

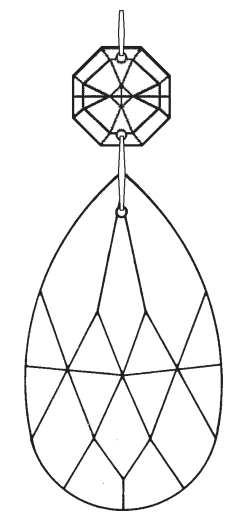

**N4000-\*\***  
3"  
76mm

**SET 2**

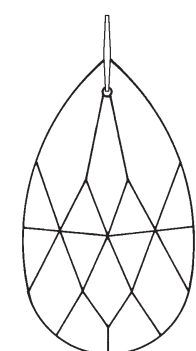

**N4014-\*\***  
2-1/2"  
63mm

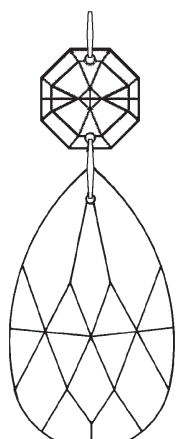

**N4003-\*\***  
2-1/2"  
63mm

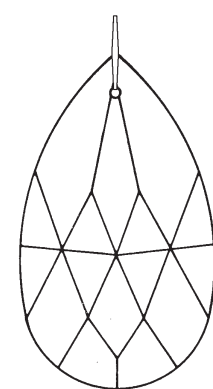

**N4004-\*\***  
3"  
76mm

**SET 3**

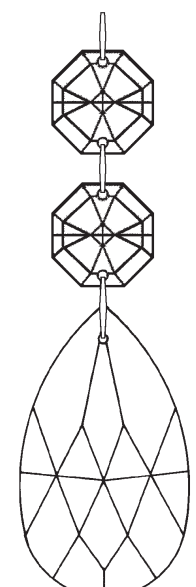

**N4015-\*\***  
2-1/2"  
63mm

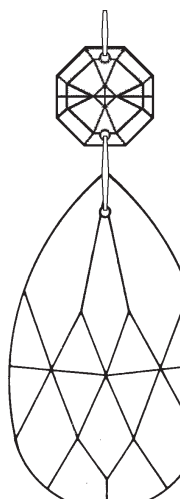

**N4000-\*\***  
3"  
76mm

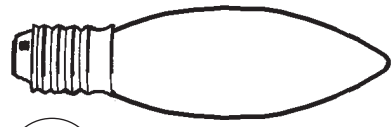

20

You will need 8 - B10  
25 Watts Recommended  
60 Watts Max

Install bulb and be sure  
to test fixture BEFORE  
trimming.

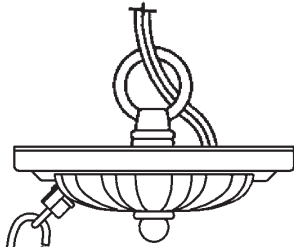

Crystal Set 1 in Black



21

9552/150

24

N4000-\*\*

23

N4014-\*\*

22

N4014-\*\*

29

N4004-\*\*

28

N4004-\*\*

27

N4003-\*\*

25

N439\*\*-\*\*

26

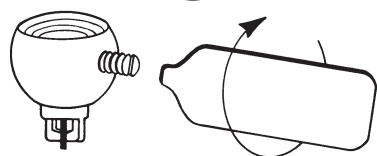

Crystal Set 2 in Black

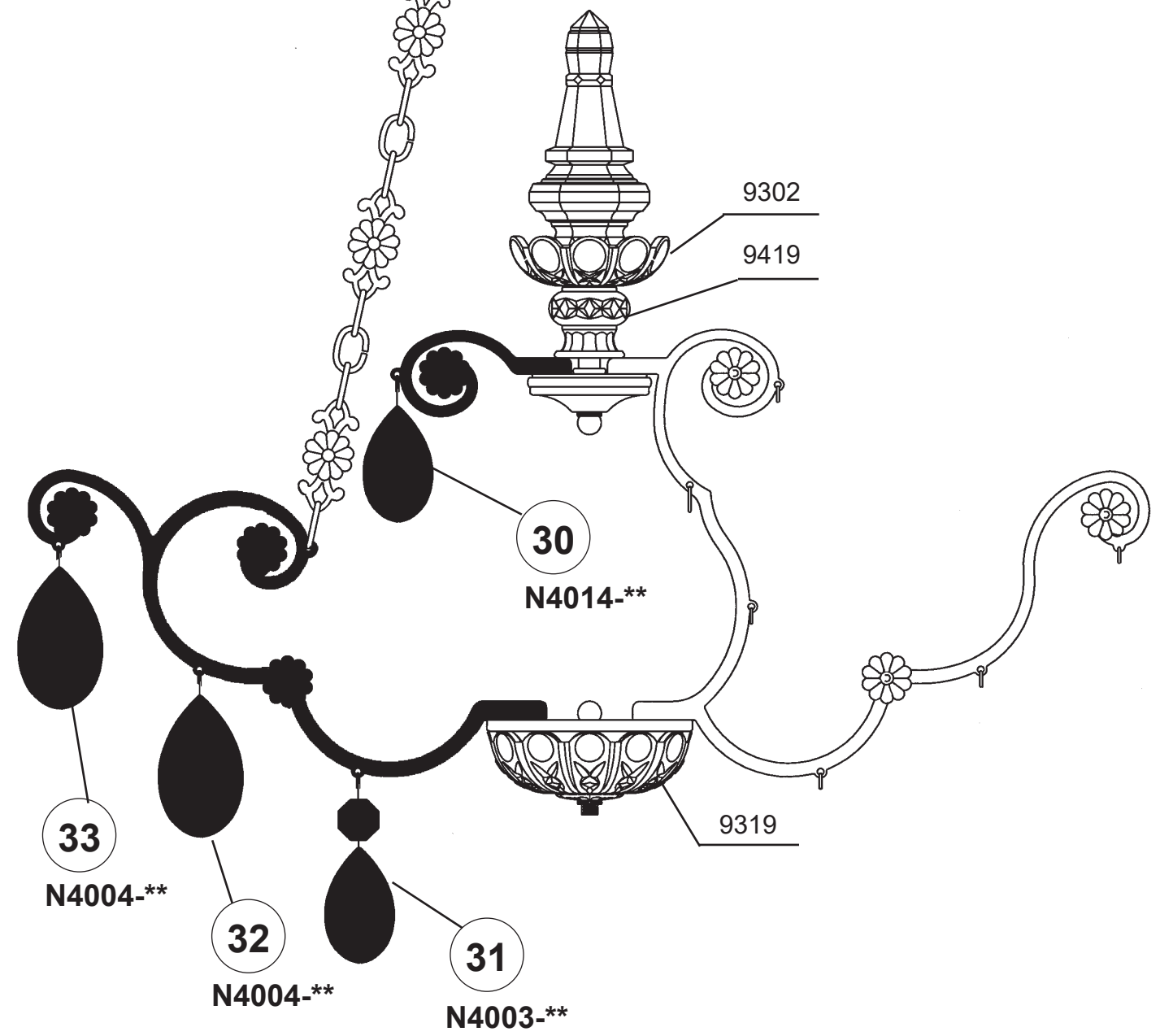

9302

9419

30

N4014-\*\*

9319

33

N4004-\*\*

32

N4004-\*\*

31

N4003-\*\*

