

 **SCHONBEK** | 1870











**RENAISSANCE**  
**3795N- \_\_ \_\_ H**



**T**HIS DESIGN IS THE PROPRIETARY  
TRADE DRESS/TRADEMARK OF  
W SCHONBEK LLC.

10 + 2 Lights  
Length: 46-1/2"  
Width: 22"  
Height: 34"  
Hanging Weight: 46lbs.

 **SCHONBEK** | 1870

								
MAX 60 W	MAX 15 W	110-120 V						

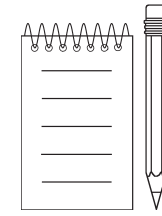
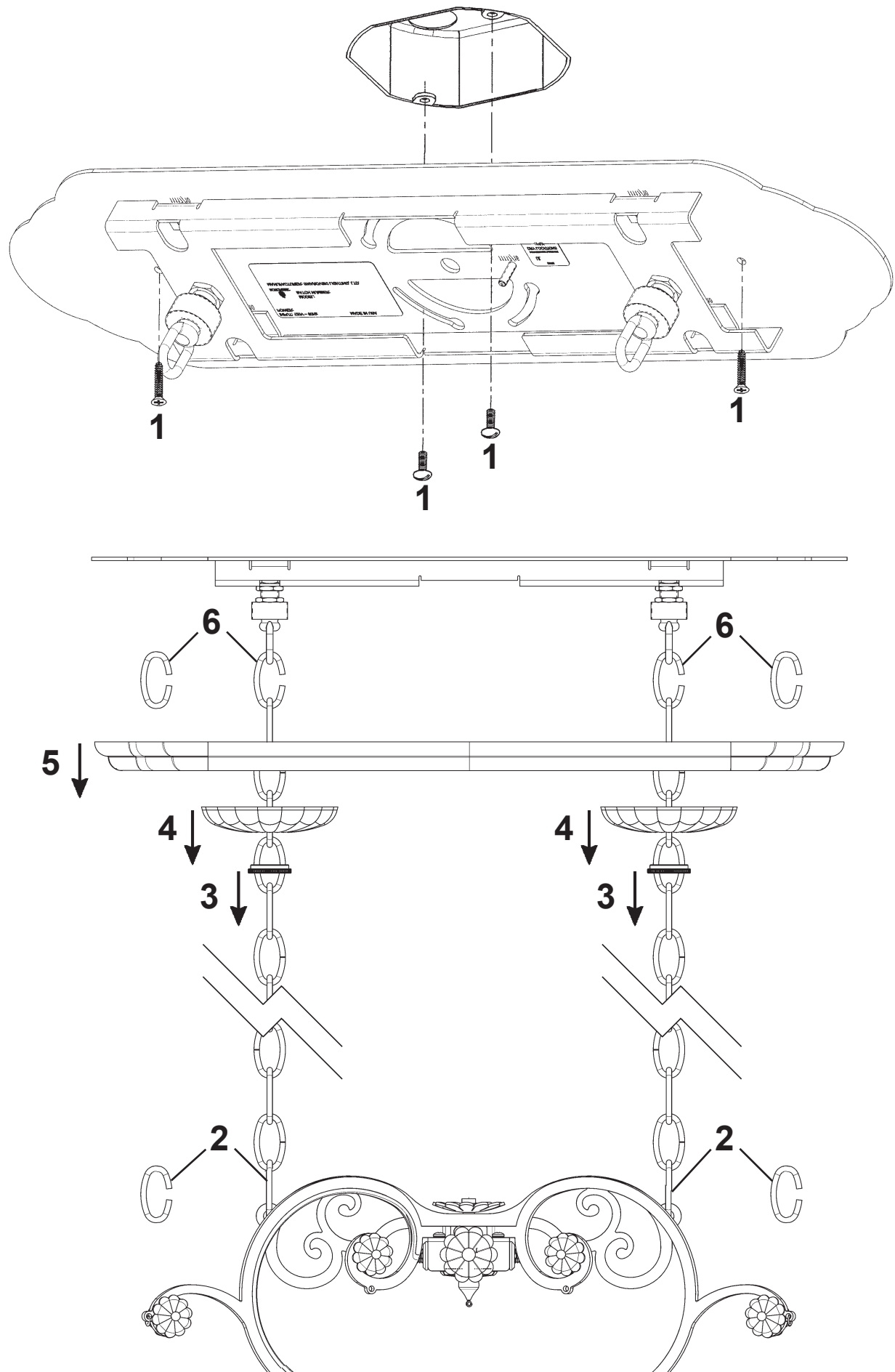

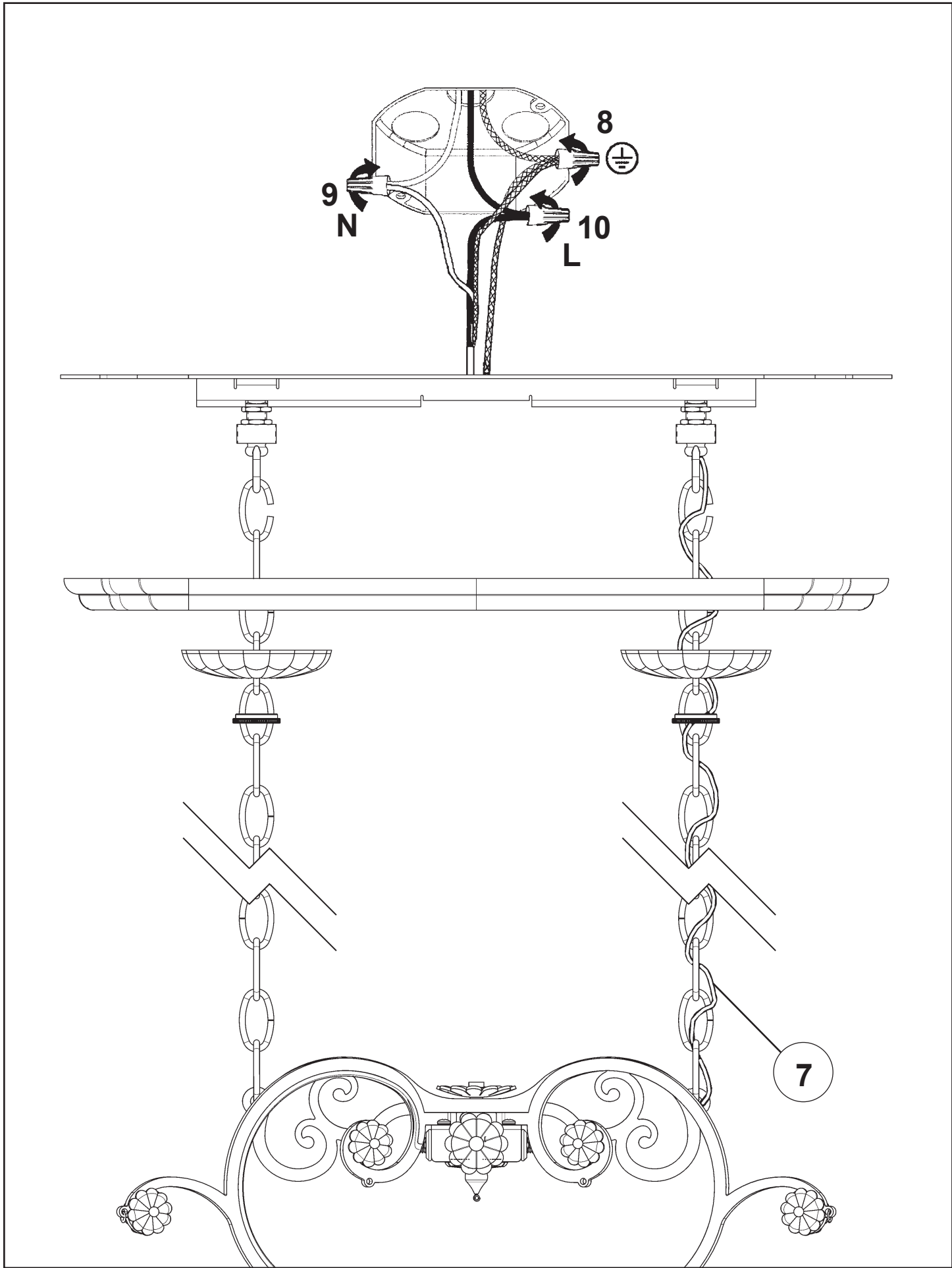
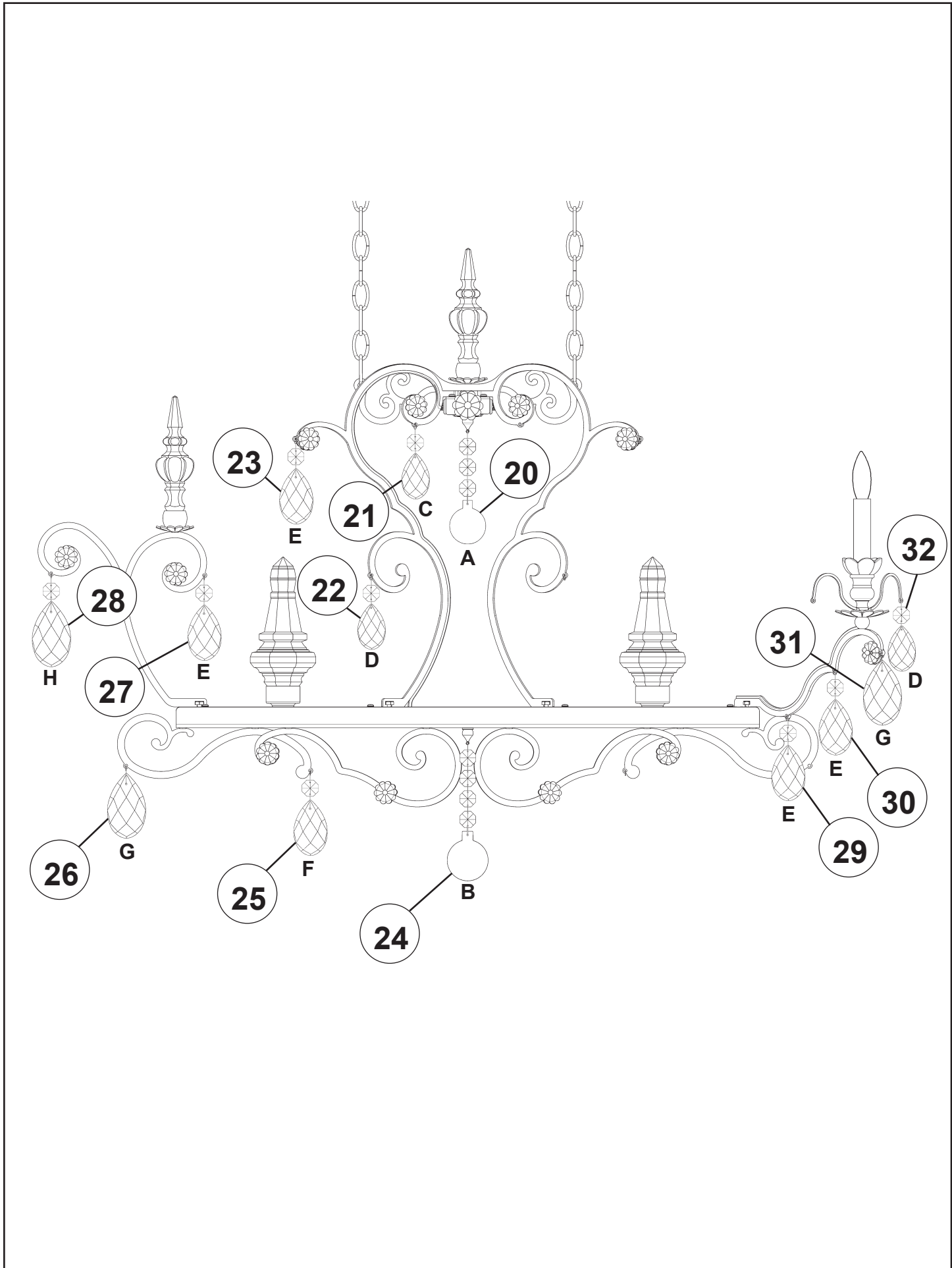

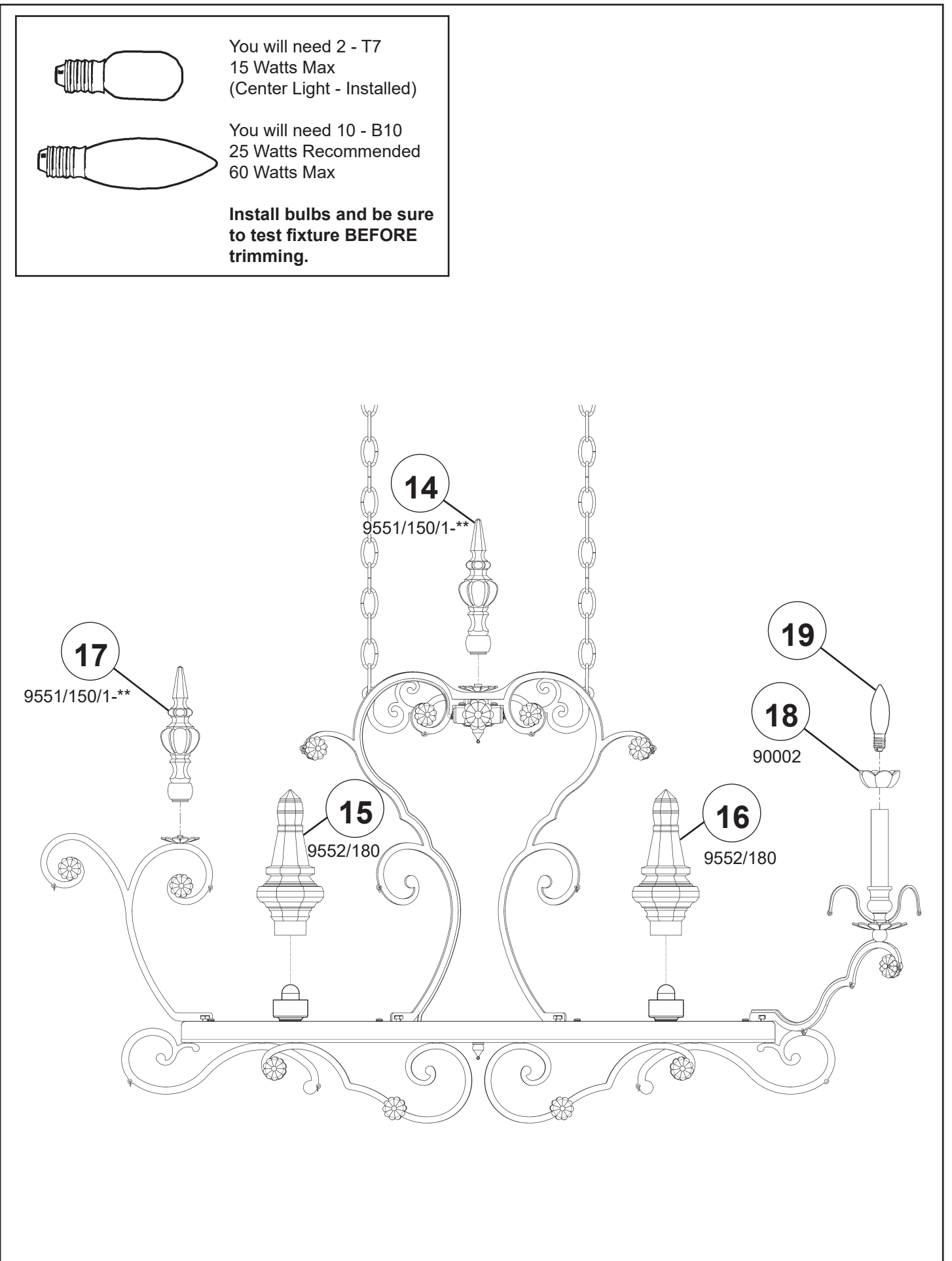
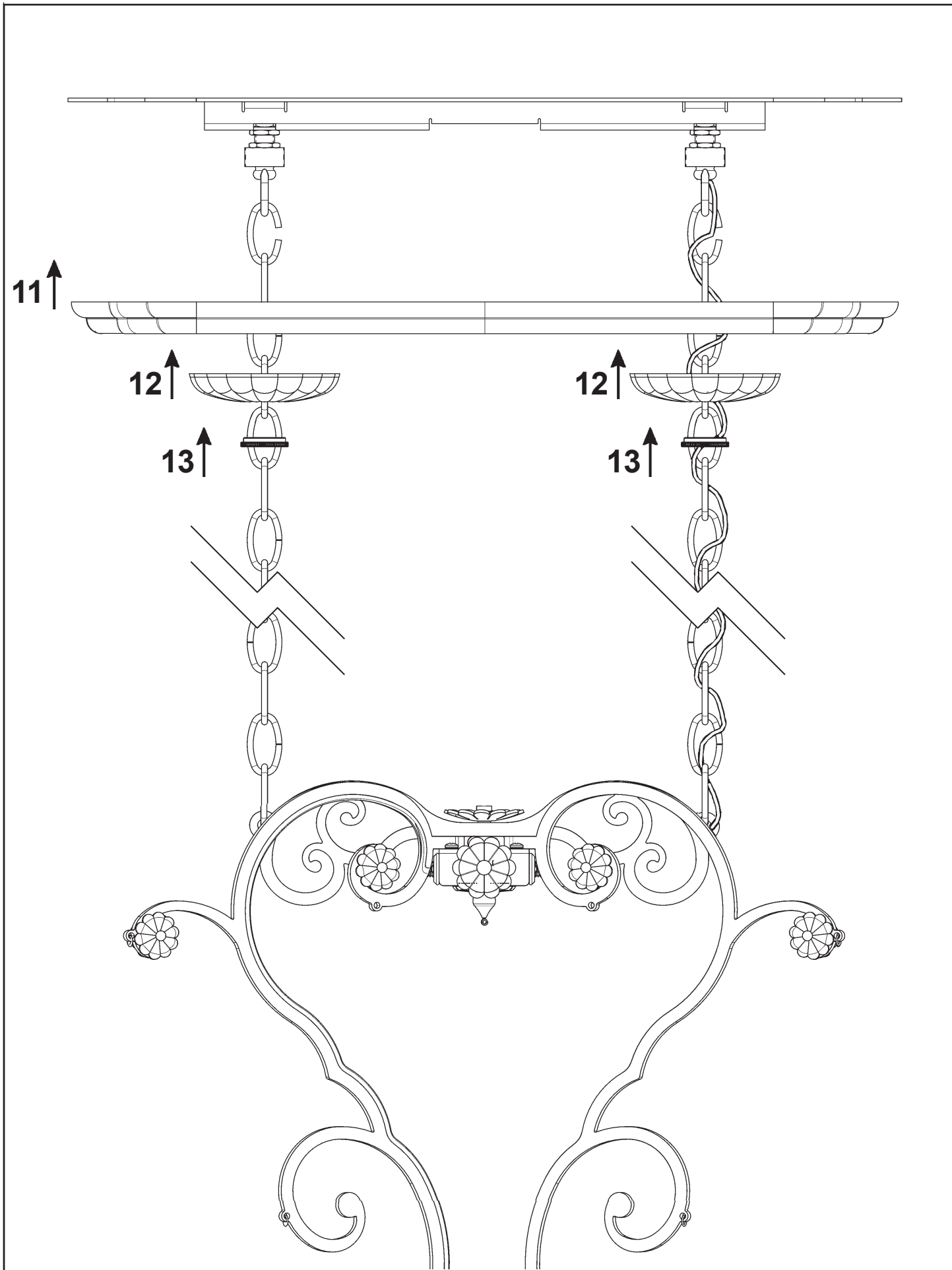

 **SCHONBEK** | 1870









**RENAISSANCE**  
**3795N- \_ \_ \_ \_ \_**



**T**HIS DESIGN IS THE PROPRIETARY  
TRADE DRESS/TRADEMARK OF  
W SCHONBEK LLC.

10 + 2 Lights  
Length: 46-1/2"  
Width: 22"  
Height: 34"  
Hanging Weight: 46lbs.

 **SCHONBEK** | 1870

			<b>S</b>					
MAX <u>60</u> W	MAX <u>15</u> W	110-120 V	