

 **SCHONBEK** | 1870

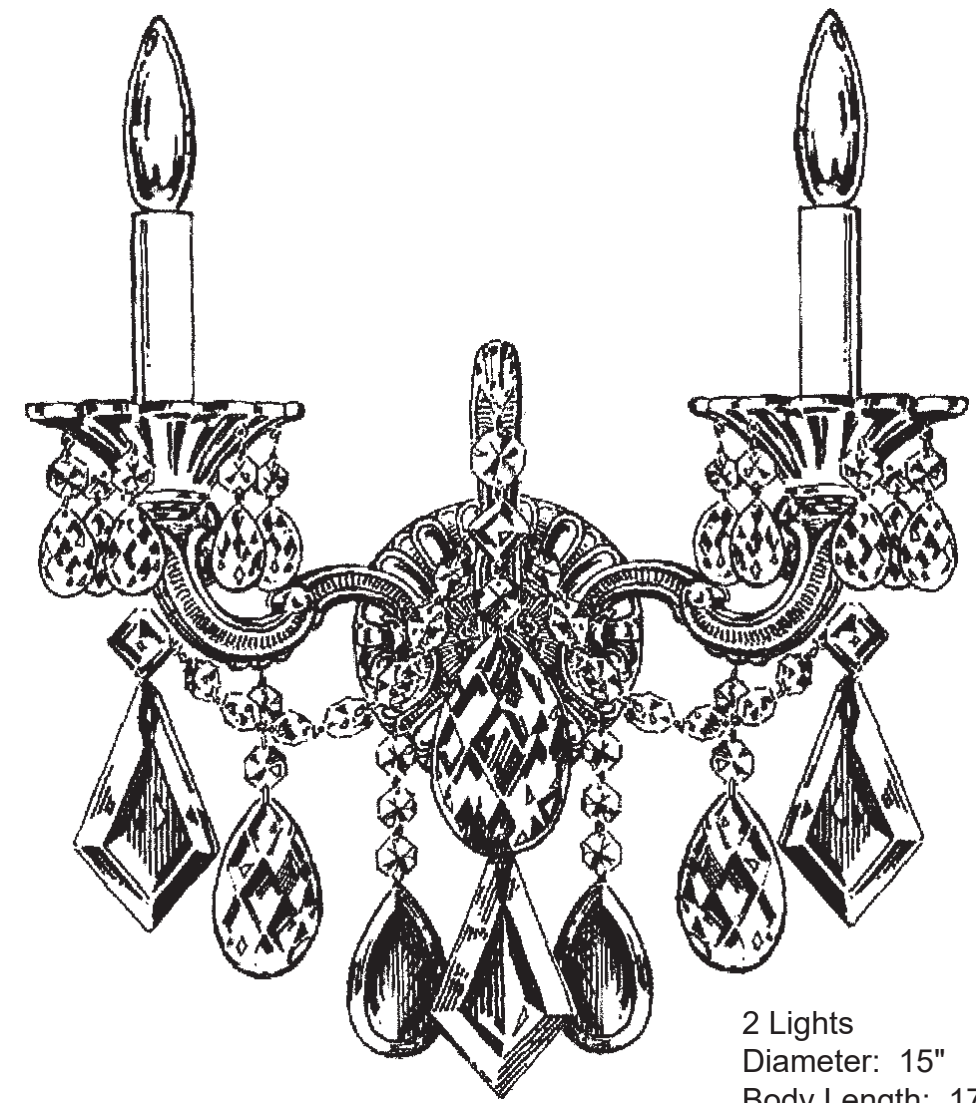









LA SCALA 5001- _ _ _



2 Lights
Diameter: 15"
Body Length: 17"
Extension: 6"
Hanging Weight: 6lbs.

THIS DESIGN IS THE PROPRIETARY TRADE DRESS/TRADEMARK OF W SCHONBEK LLC.

 **SCHONBEK** | 1870

								
MAX 60 W	110-120 V							

All electrical components must be installed by a licensed electrician in accordance with the National Electric Code and the appropriate local electrical codes.

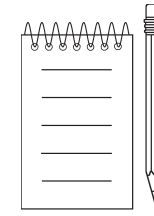
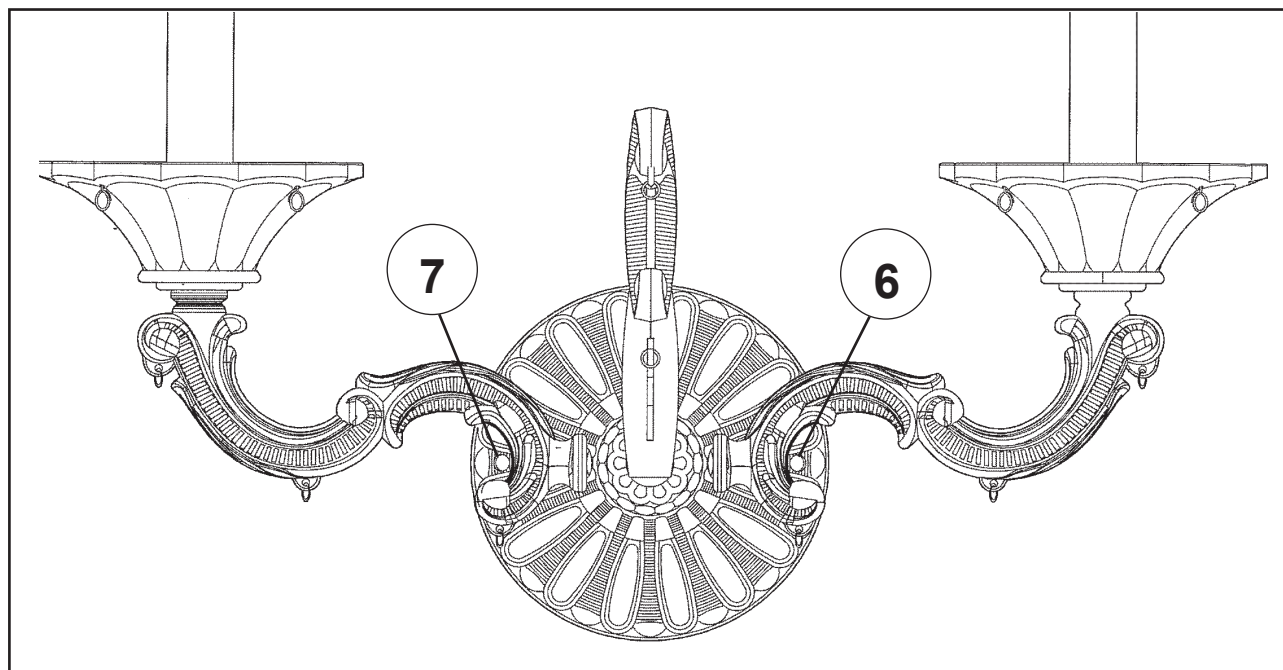
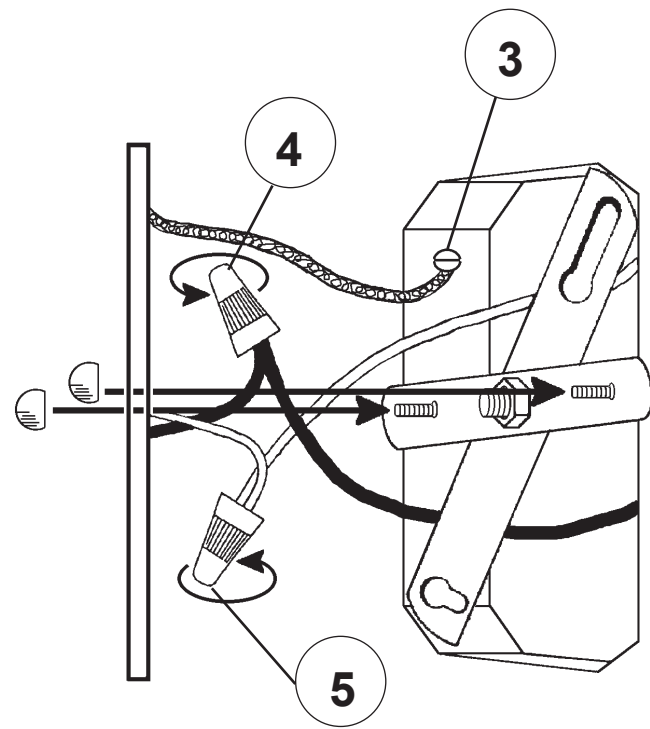
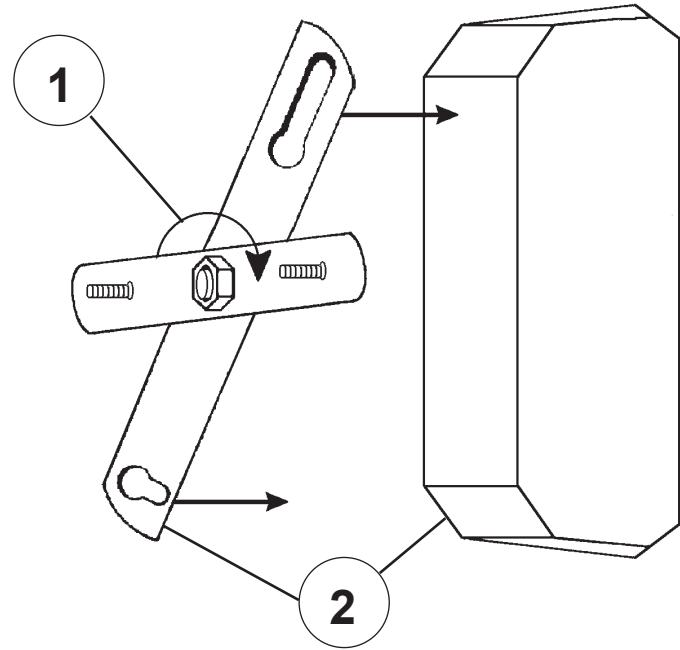

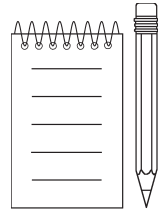



8

You will need 2 - B10
25 Watts Recommended
60 Watts Max

Install bulbs and be sure
to test fixture **BEFORE**
trimming.

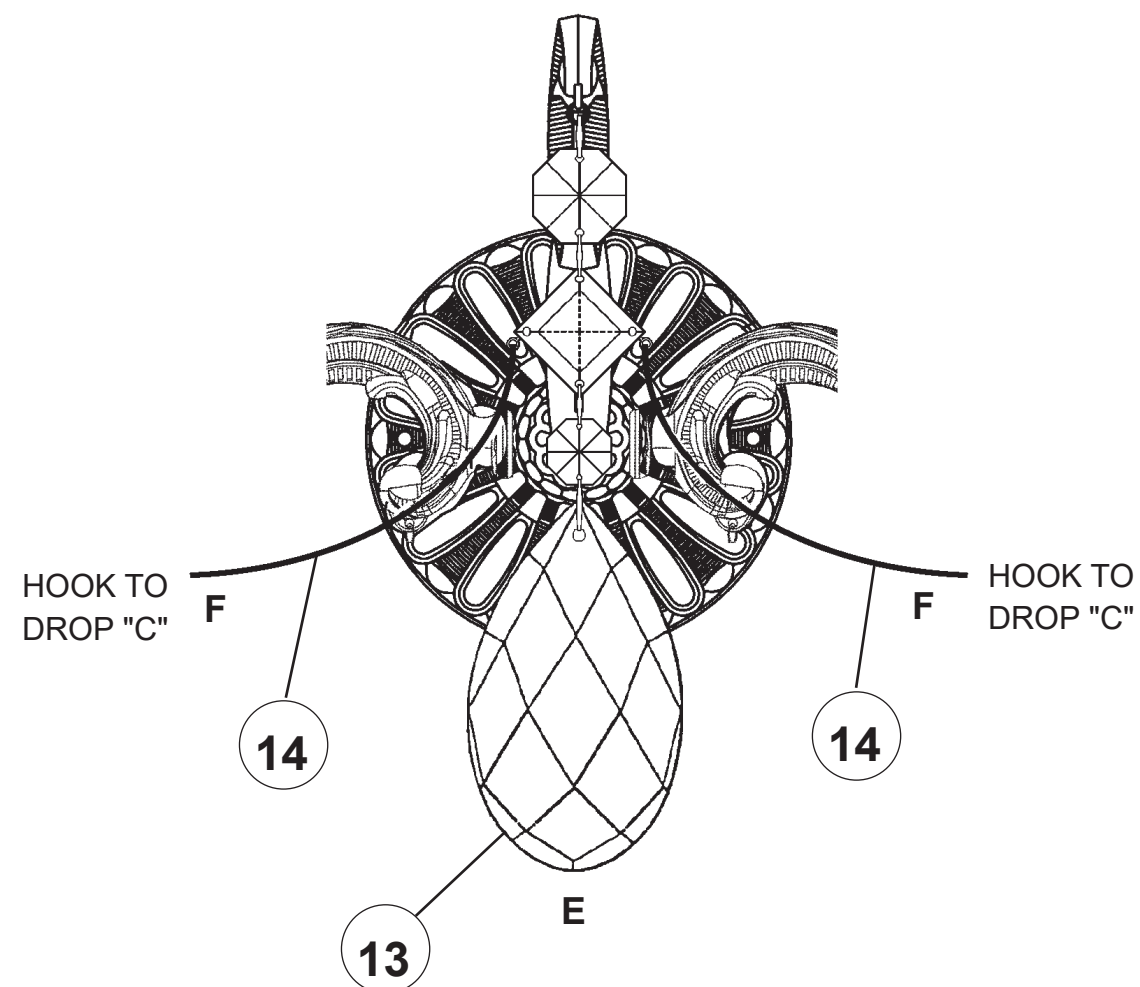
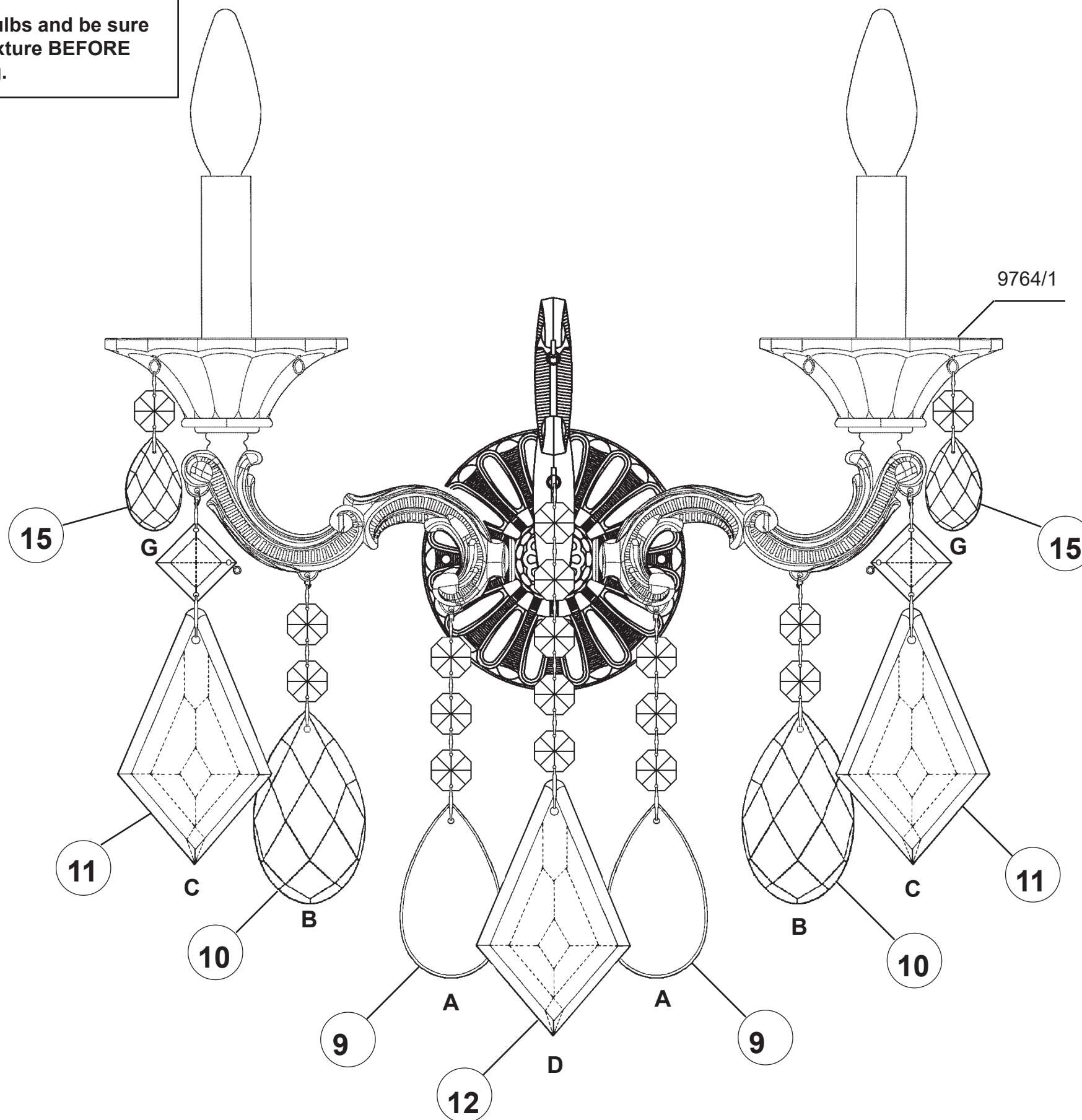

 **SCHONBEK** | 1870











LA SCALA 5001- __ __ R



2 Lights
Diameter: 15"
Body Length: 17"
Extension: 6"
Hanging Weight: 6lbs.

THIS DESIGN IS THE PROPRIETARY
TRADE DRESS/TRADEMARK OF
W SCHONBEK LLC.

 **SCHONBEK** | 1870

								
MAX 60 W		110-120 V						

All electrical components must be installed by a licensed electrician in accordance with the National Electric Code and the appropriate local electrical codes.

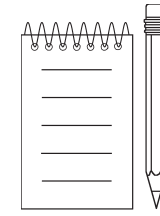
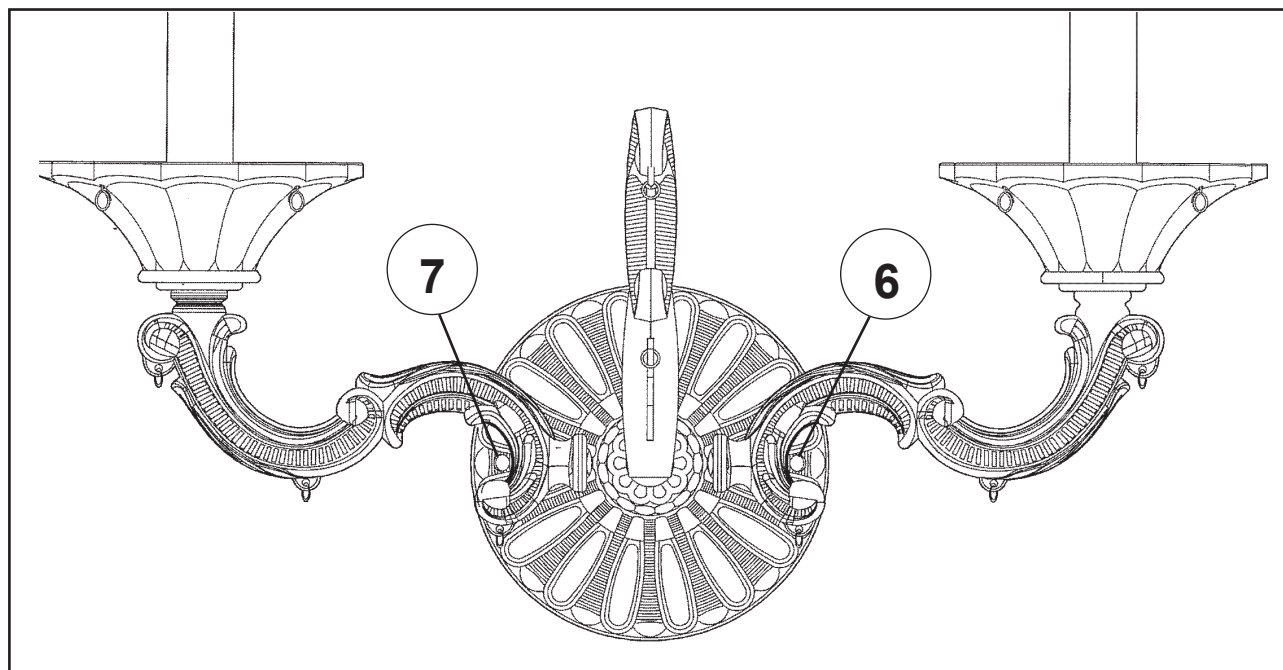
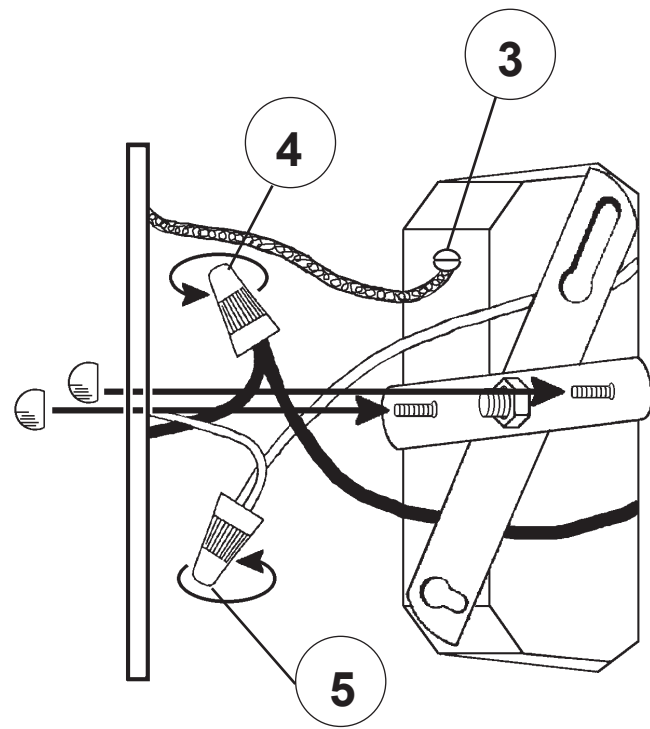
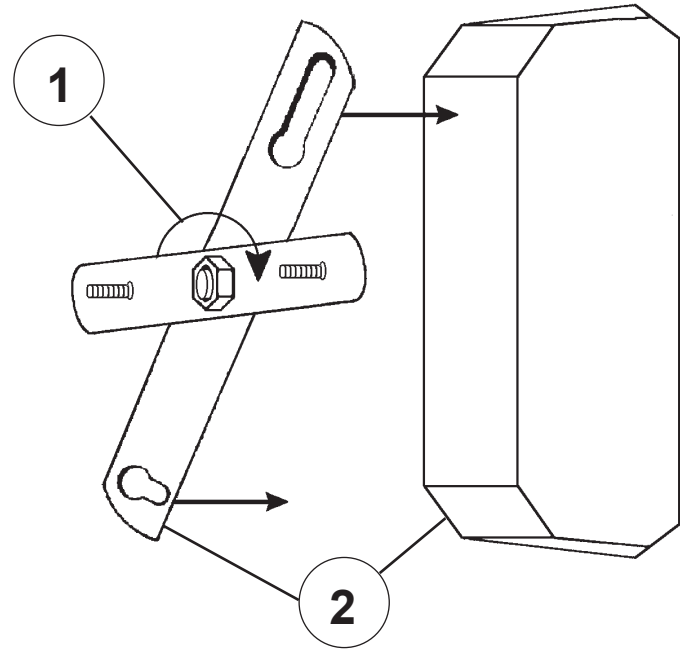

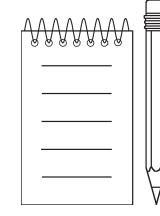
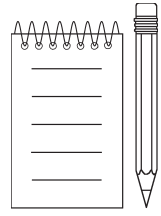



8

You will need 2 - B10
25 Watts Recommended
60 Watts Max

Install bulbs and be sure
to test fixture **BEFORE**
trimming.

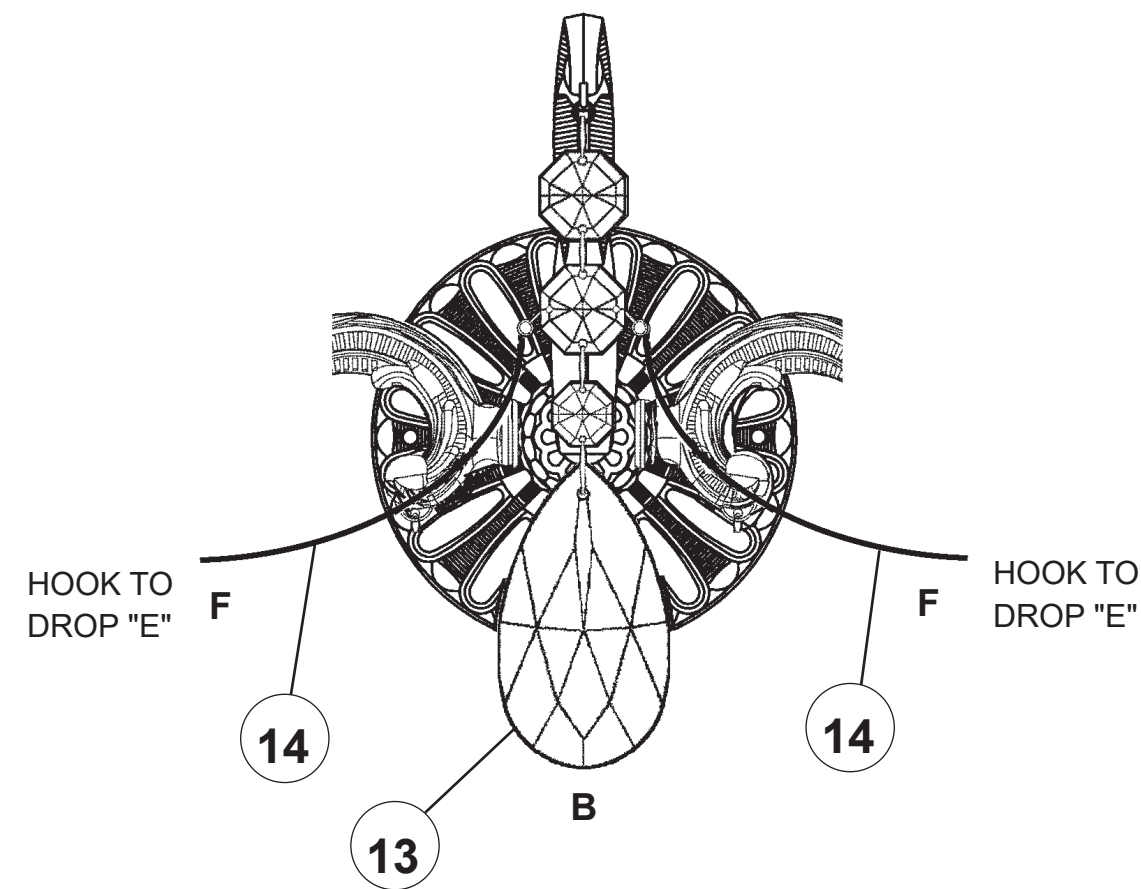
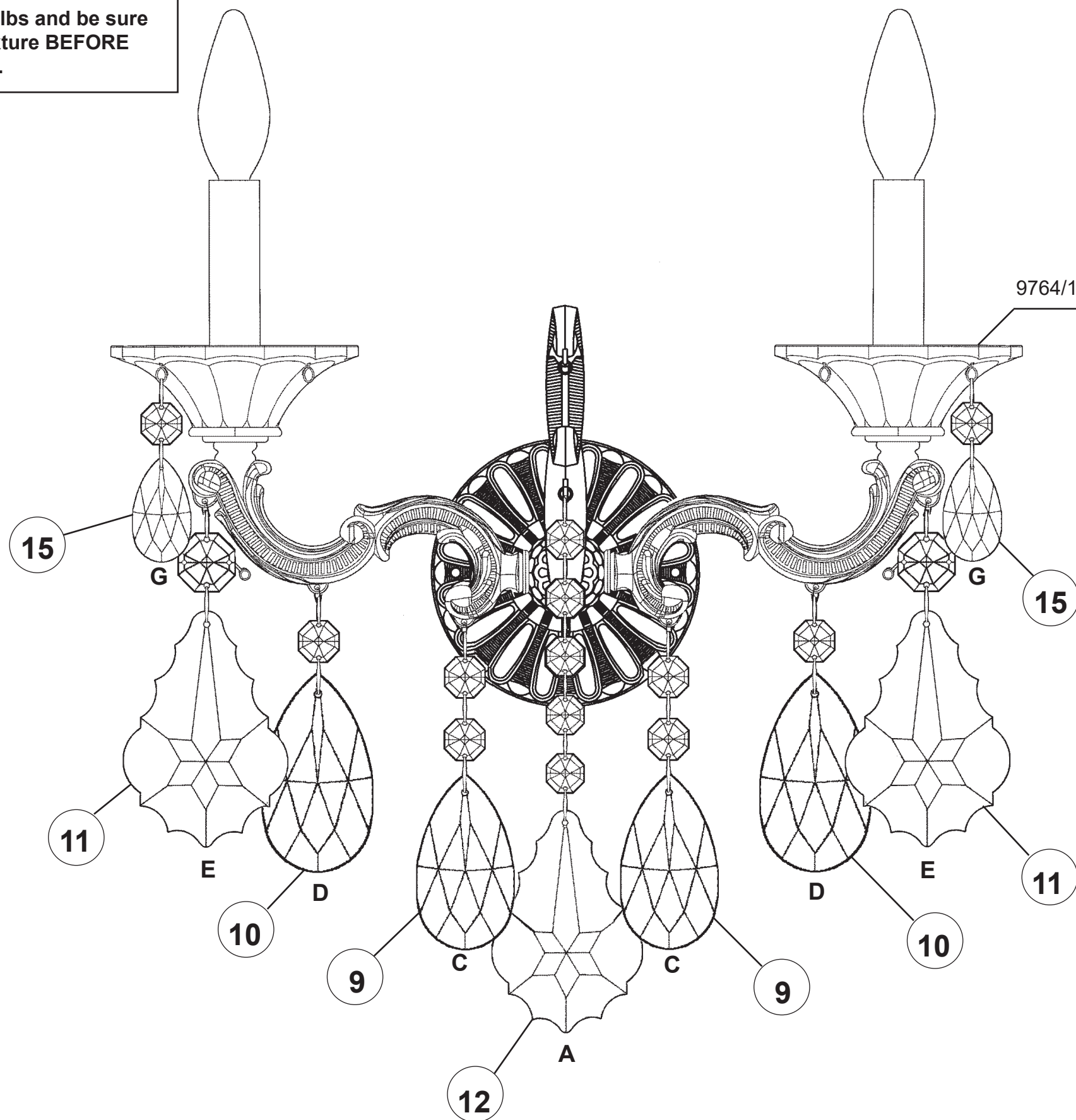

 **SCHONBEK** | 1870



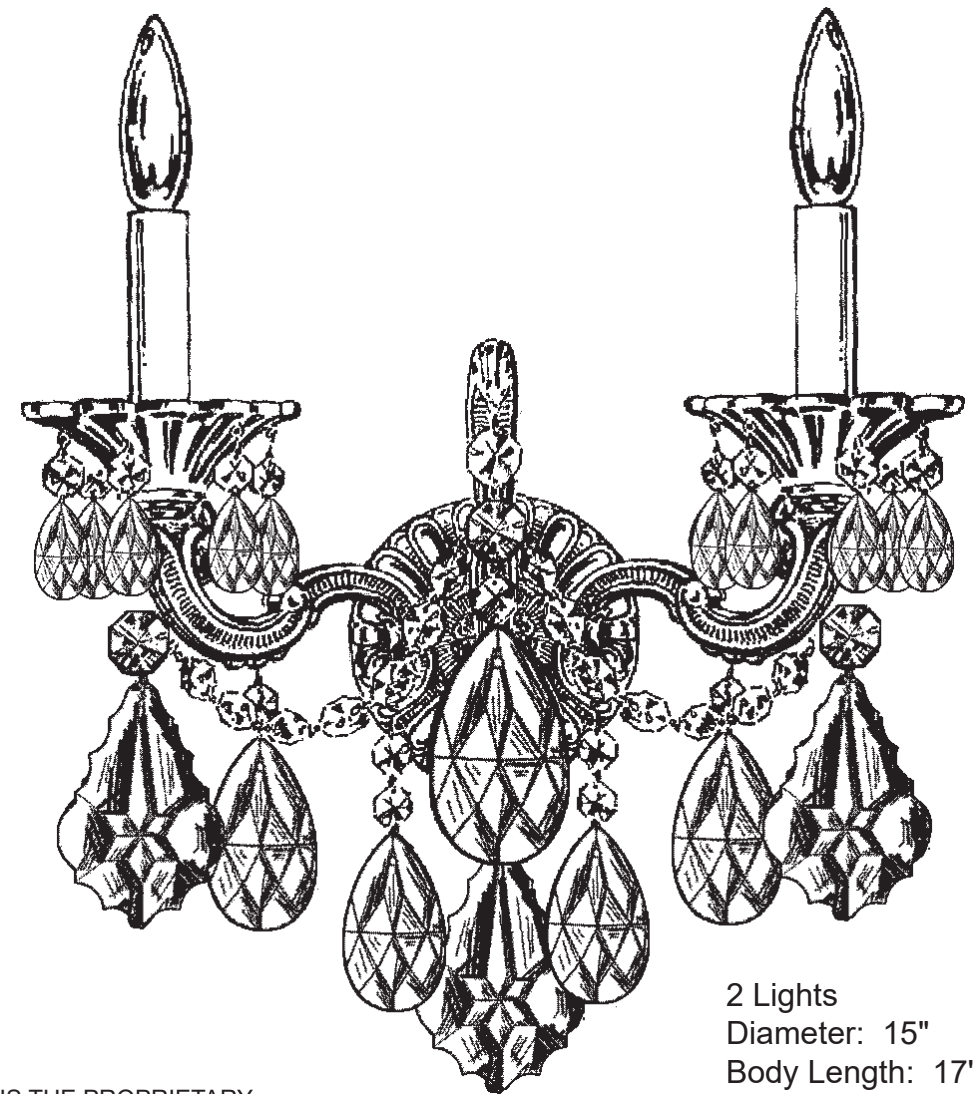







LA SCALA 5001- _____



2 Lights
Diameter: 15"
Body Length: 17"
Extension: 6"
Hanging Weight: 6lbs.

THIS DESIGN IS THE PROPRIETARY
TRADE DRESS/TRADEMARK OF
W SCHONBEK LLC.

 **SCHONBEK** | 1870

								
MAX 60 W		110-120 V						

All electrical components must be installed by a licensed electrician in accordance with the National Electric Code and the appropriate local electrical codes.

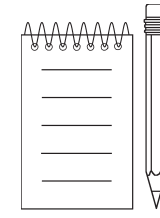
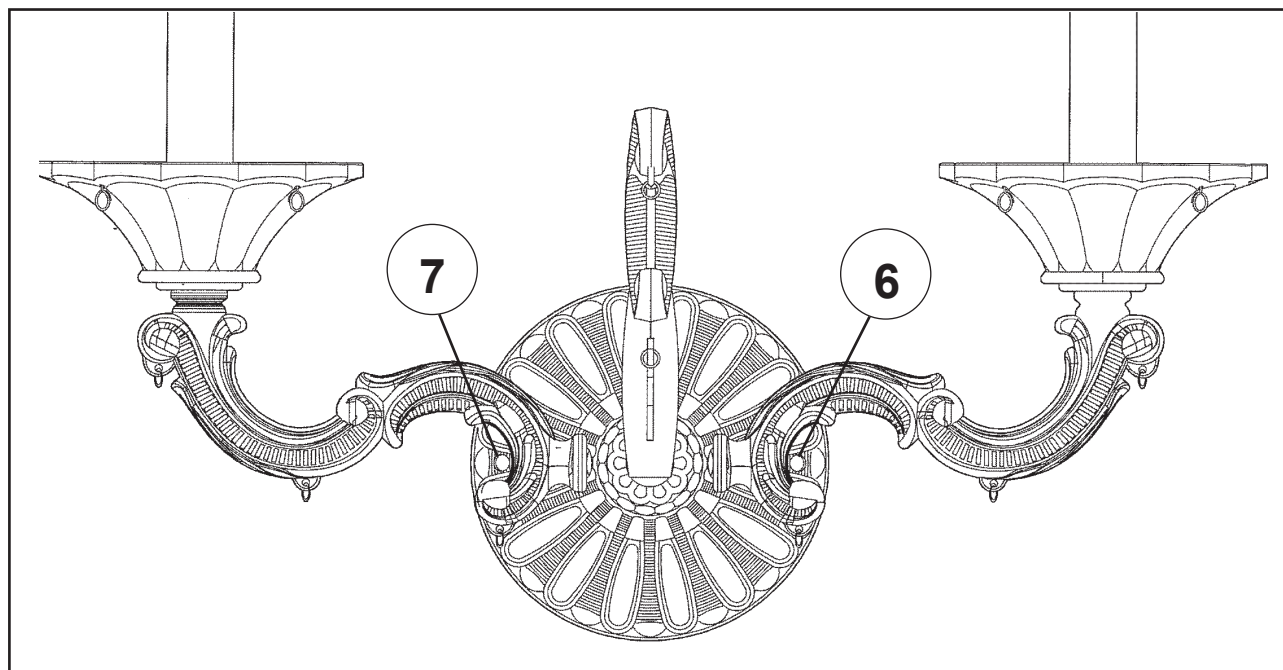
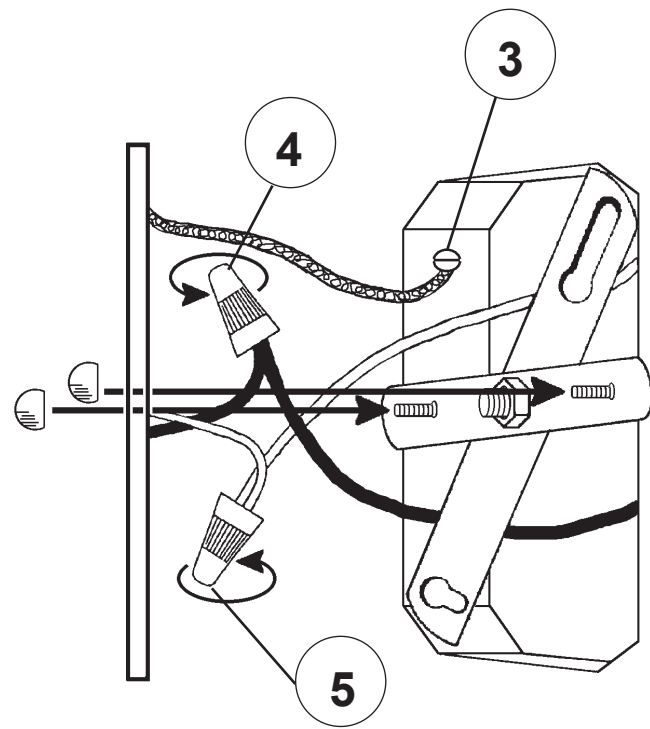
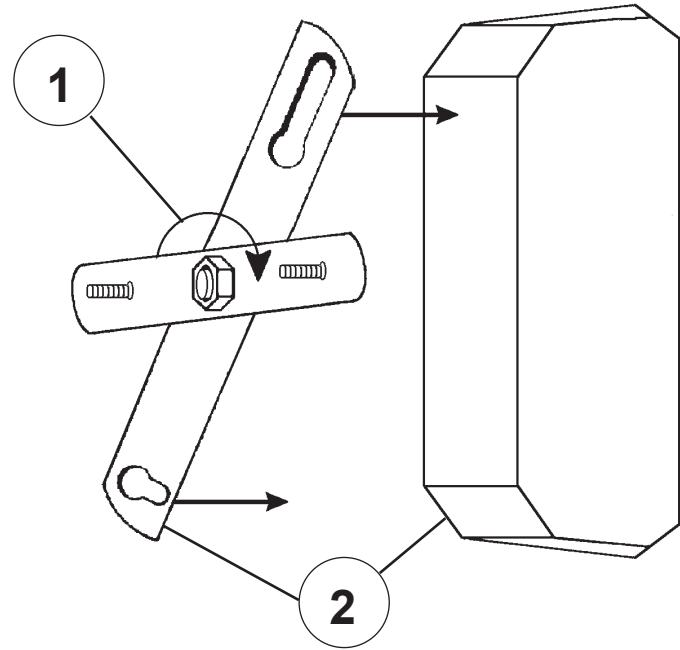

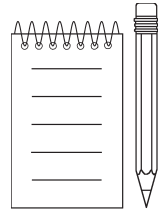



8

You will need 2 - B10
25 Watts Recommended
60 Watts Max

Install bulbs and be sure
to test fixture **BEFORE**
trimming.

