

CHANDELIER 5502AM TRIM DIAGRAM



THIS DESIGN IS THE PROPRIETARY TRADE DRESS/TRADemark OF SCHONBEK WORLDWIDE LIGHTING INC.

2 Lights
Diameter: 14-1/2"
Body Length: 20-1/2"
Extension: 6-1/2"

SCHONBEK®

This crystal chandelier was designed and manufactured in Plattsburgh, N.Y. Our high-quality crystal fixtures are made with state-of-the-art manufacturing equipment. If you have any questions about this or any of our more than 450 crystal products, contact your nearest authorized Schonbek distributor.

CAUTION... RISK OF ELECTRICAL SHOCK. Make sure the electrical supply to the chandelier is turned off at the main fuse or circuit breaker before doing any installation. All electrical components must be installed by a licensed electrician in accordance with the National Electric Code and the appropriate local electrical codes.

HANGING WEIGHT: 6.5 pounds

BULBS: 2 - Candle shaped candelabra base C10 bulbs, recommend 25 watts for best appearance.
60 - Watt Maximum

WARNING: This chandelier meets UL/CSA requirements. Any tampering will void UL/CSA certification.

MAINTENANCE:

Use a soft, lint - free cloth to clean the metal frame.

UNDER NO CIRCUMSTANCES SHOULD METAL POLISHES, CLEANERS, ABRASIVES OR AEROSOL SPRAYS BE USED.

While the latest finishing techniques have been used on the metal frame, such finish cannot be unconditionally guaranteed. The main cause of deterioration, apart from certain atmospheric conditions, is improper cleaning.

To clean the crystals, polish with a damp chamois.

You are cleaning delicate crystal... Take the greatest care.

IMPORTANT:

Do not clean crystals in a dishwasher. The finish of the metal clips and hangers will be ruined and the crystals may be damaged.

IMPORTANT
Please record the following information for future service.

CODE	# _____	Four-digit number on outside of carton.
PACKER	# _____	See crystal package label.
ORDER	# _____	See crystal package label.

CAUTION: Glass parts are fragile. COLOR →
To avoid breakage use care when assembling or cleaning.

WHEN ORDERING REPLACEMENT ARM(S):

- Give arm number from trim diagram
- Give color code from the arm itself

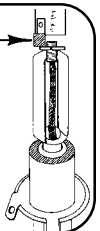

1 MAKE SURE THAT POWER TO THE OUTLET BOX IS DISCONNECTED!!

2 Thread long screw "A" through crossbar "B" and attach crossbar to outlet box using 2 screws round head 8-32 x 1" (not supplied with wall bracket.)

3 Test fit wall bracket by guiding it over screw "A". Adjust screw "A" so that it extends approximately 1/4" through wall bracket. Remove wall bracket. Thread nut "C" onto screw and tighten it against crossbar. (NOTE: In some installations, due to space, nut "C" might have to go on the other side of the crossbar.)

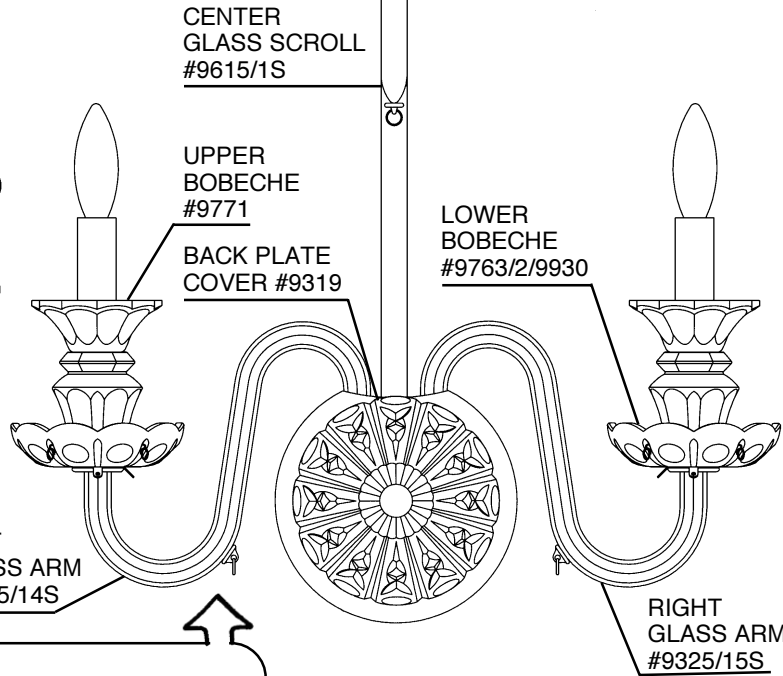
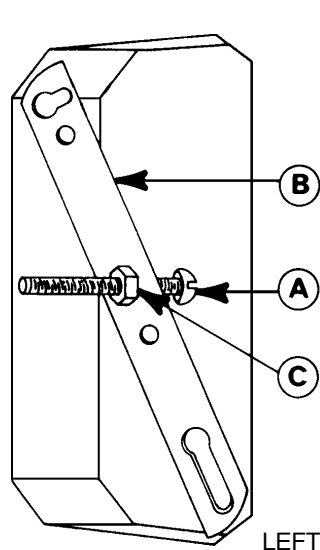

4 Turn arm to line up hole in arm with dimple in plate. Tighten lock washer and nut to secure arm in place.

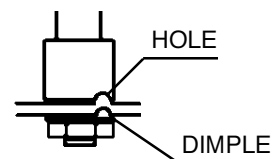

5 Connect the wires of the wall bracket to the power wires of the outlet box, guide wall bracket over screw "A" and secure with threaded half ball supplied. NOTE: Fixture MUST be grounded.

6 Install bobèches and screw bulb into all socket(s). Test power to insure proper wiring before hanging trim from fixture.

VIEW "A"

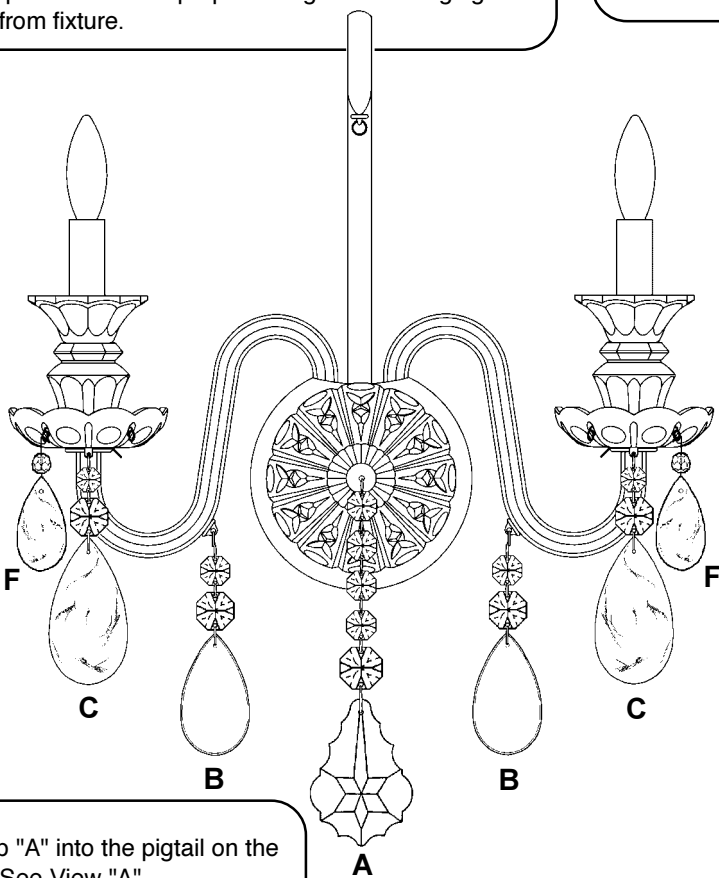

VIEW "B"

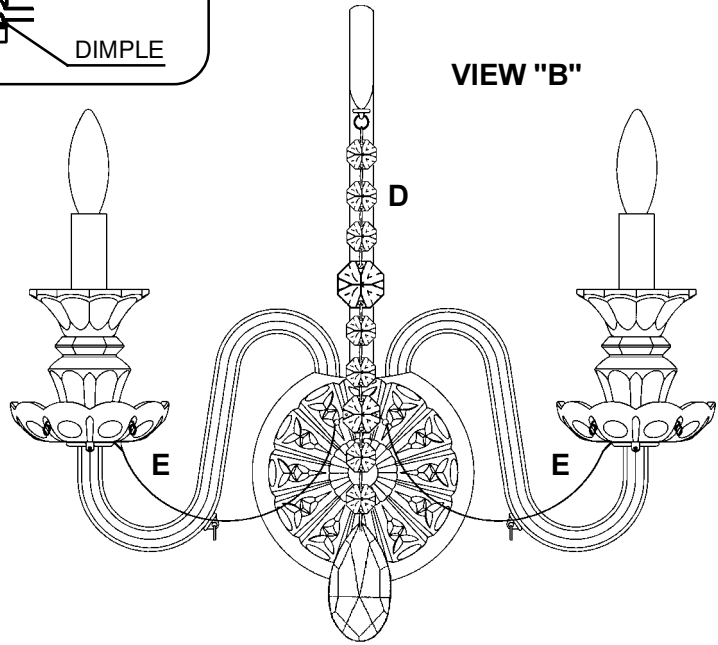

7 Hook Drop "A" into the pigtail on the center knob. See View "A".

8 Hook Drops "B" into the lower ring on the glass arms. See View "A".

9 Hook Drops "C" into the front tabs under the bobèche. See View "A".

10 Hook Drop "D" into the ring on the glass scroll. See View "B".

11 Hook Chains "E" into the rings of Drop "D". Hook the other end into the side tabs under the bobèche. Chains "E" are swagged between the Drop "D" and the glass arms. See View "B".

12 Every bobèche is trimmed with Drops "F", suspended from every ring between the scallops. See View "A".

CHANDELIER 5502BK TRIM DIAGRAM



THIS DESIGN IS THE PROPRIETARY
TRADE DRESS/TRADEMARK OF
SCHONBEK WORLDWIDE LIGHTING INC.

2 Lights
Diameter: 14-1/2"
Body Length: 20-1/2"
Extension: 6-1/2"

SCHONBEK®

This crystal chandelier was designed and manufactured in Plattsburgh, N.Y. Our high-quality crystal fixtures are made with state-of-the-art manufacturing equipment. If you have any questions about this or any of our more than 450 crystal products, contact your nearest authorized Schonbek distributor.

CAUTION... RISK OF ELECTRICAL SHOCK. Make sure the electrical supply to the chandelier is turned off at the main fuse or circuit breaker before doing any installation. All electrical components must be installed by a licensed electrician in accordance with the National Electric Code and the appropriate local electrical codes.

HANGING WEIGHT: 7 pounds

BULBS: 2 - Candle shaped candelabra base C10 bulbs, recommend 25 watts for best appearance.
60 - Watt Maximum

WARNING: This chandelier meets UL/CSA requirements. Any tampering will void UL/CSA certification.

MAINTENANCE:

Use a soft, lint - free cloth to clean the metal frame.

**UNDER NO CIRCUMSTANCES SHOULD METAL POLISHES, CLEANERS,
ABRASIVES OR AEROSOL SPRAYS BE USED.**

While the latest finishing techniques have been used on the metal frame, such finish cannot be unconditionally guaranteed. The main cause of deterioration, apart from certain atmospheric conditions, is improper cleaning.

To clean the crystals, polish with a damp chamois.

You are cleaning delicate crystal... Take the greatest care.

IMPORTANT:

Do not clean crystals in a dishwasher. The finish of the metal clips and hangers will be ruined and the crystals may be damaged.

IMPORTANT

Please record the following information for future service.

CODE	# _____	Four-digit number on outside of carton.
PACKER	# _____	See crystal package label.
ORDER	# _____	See crystal package label.

CAUTION: Glass parts are fragile. To Avoid breakage use care when assembling or cleaning.

1 MAKE SURE THAT POWER TO THE OUTLET BOX IS DISCONNECTED!!

2 Thread long screw "A" through crossbar "B" and attach crossbar to outlet box using 2 screws round head 8-32 x 1" (not supplied with wall bracket.)

3 Test fit wall bracket by guiding it over screw "A". Adjust screw "A" so that it extends approximately 1/4" through wall bracket. Remove wall bracket. Thread nut "C" onto screw and tighten it against crossbar. (NOTE: In some installations, due to space, nut "C" might have to go on the other side of the crossbar.)

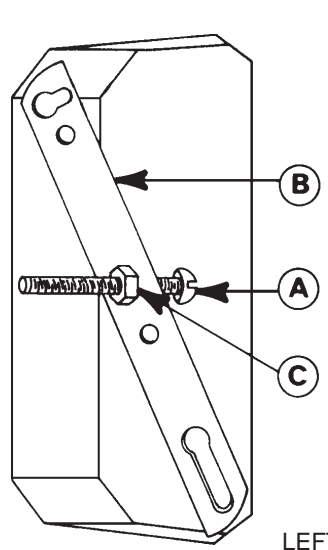

CENTER GLASS SCROLL #9615/1BLACK

UPPER BOBECHE #90255/75BLACK

BACK PLATE COVER #90263BLACK

#90256BLACK

LOWER BOBECHE #90262/1BLACK

LEFT GLASS ARM #9325/14BLACK

RIGHT GLASS ARM #9325/15BLACK

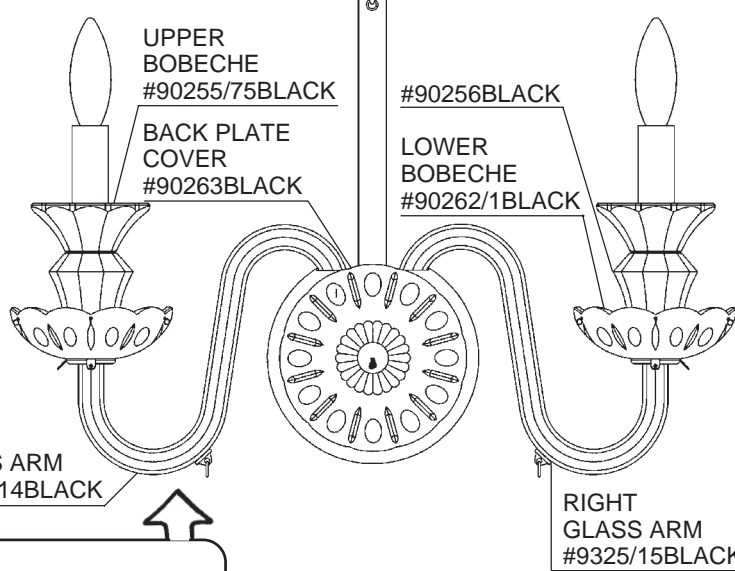

5 Connect the wires of the wall bracket to the power wires of the outlet box, guide wall bracket over screw "A" and secure with threaded half ball supplied. NOTE: Fixture MUST be grounded.

6 Install bobeches and screw bulb into all socket(s). Test power to insure proper wiring before hanging trim from fixture.

4 Turn arm to line up hole in arm with dimple in plate. Tighten lock washer and nut to secure arm in place.

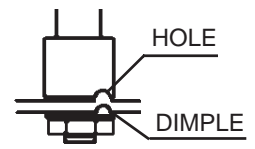

VIEW "A"

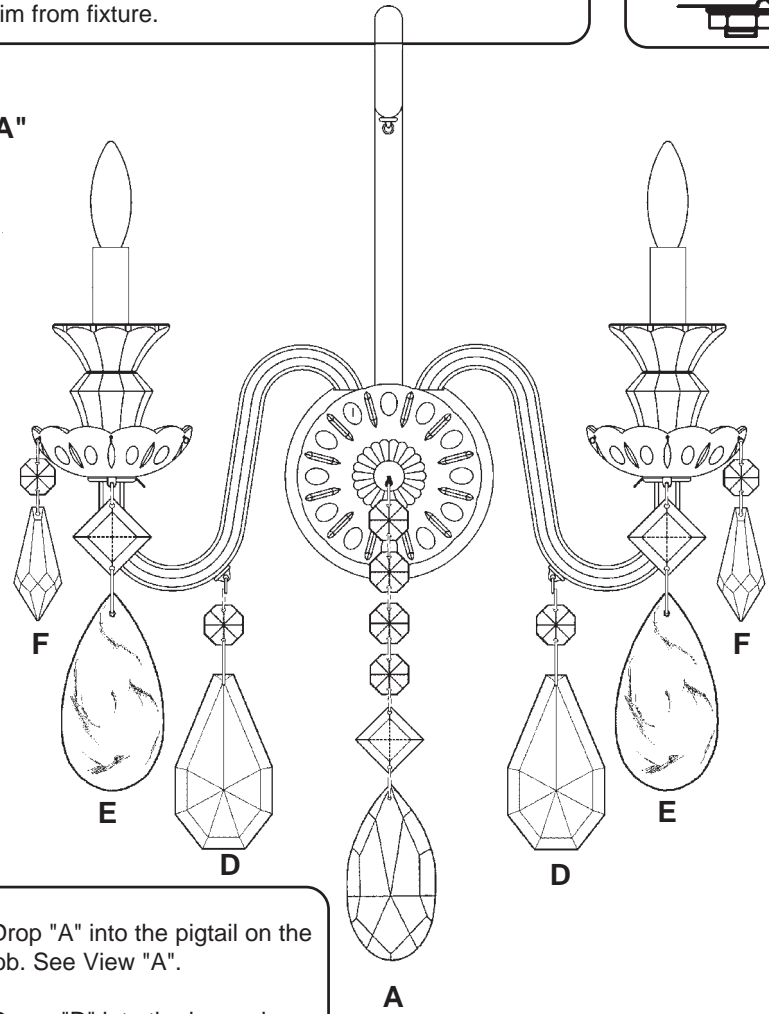

VIEW "B"

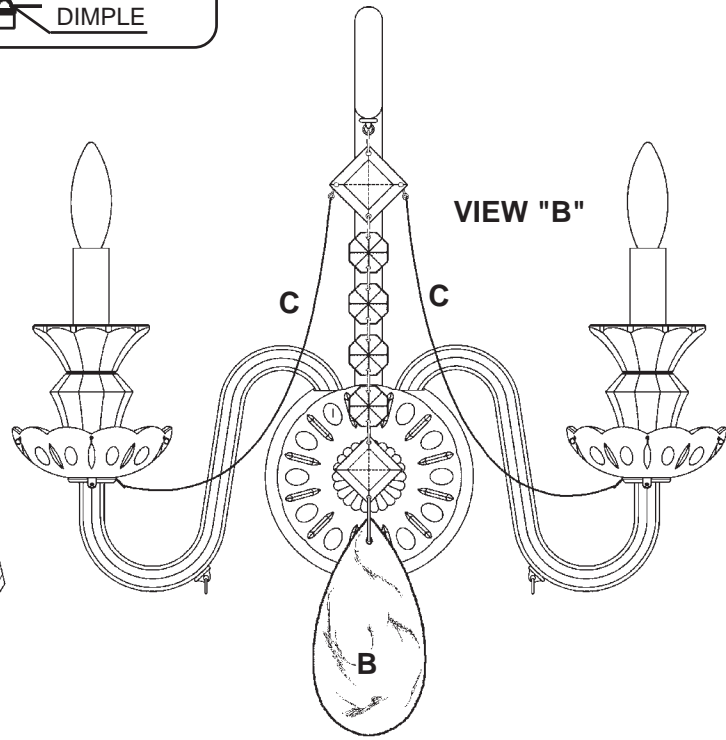

7 Hook Drop "A" into the pigtail on the center knob. See View "A".

8 Hook Drops "D" into the lower ring on the glass arms. See View "A".

9 Hook Drops "E" into the front tabs under the bobeches. See View "A".

10 Hook Drop "B" into the ring on the glass scroll. See View "B".

11 Hook Chains "C" into the rings of Drop "B". NOTE: Chains "C" should be hung in the following manner - at top, 8 octagons, 1 diamond, 3 octagons, at bottom. Hook the other end into the side tabs under the bobeches. Chains "C" are swagged between the Drop "B" and the glass arms. See View "B".

12 Every bobeches is trimmed with Drops "F", suspended from every ring between the scallops. See View "A".

CHANDELIER 5502CL TRIM DIAGRAM



THIS DESIGN IS THE PROPRIETARY
TRADE DRESS/TRADEMARK OF
SCHONBEK WORLDWIDE LIGHTING INC.

2 Lights
Diameter: 14-1/2"
Body Length: 20-1/2"
Extension: 6-1/2"

SCHONBEK®

This crystal chandelier was designed and manufactured in Plattsburgh, N.Y. Our high-quality crystal fixtures are made with state-of-the-art manufacturing equipment. If you have any questions about this or any of our more than 450 crystal products, contact your nearest authorized Schonbek distributor.

CAUTION... RISK OF ELECTRICAL SHOCK. Make sure the electrical supply to the chandelier is turned off at the main fuse or circuit breaker before doing any installation. All electrical components must be installed by a licensed electrician in accordance with the National Electric Code and the appropriate local electrical codes.

HANGING WEIGHT: 7 pounds

BULBS: 2 - Candle shaped candelabra base C10 bulbs, recommend 25 watts for best appearance.
60 - Watt Maximum

WARNING: This chandelier meets UL/CSA requirements. Any tampering will void UL/CSA certification.

MAINTENANCE:

Use a soft, lint - free cloth to clean the metal frame.

**UNDER NO CIRCUMSTANCES SHOULD METAL POLISHES, CLEANERS,
ABRASIVES OR AEROSOL SPRAYS BE USED.**

While the latest finishing techniques have been used on the metal frame, such finish cannot be unconditionally guaranteed. The main cause of deterioration, apart from certain atmospheric conditions, is improper cleaning.

To clean the crystals, polish with a damp chamois.

You are cleaning delicate crystal... Take the greatest care.

IMPORTANT:

Do not clean crystals in a dishwasher. The finish of the metal clips and hangers will be ruined and the crystals may be damaged.

IMPORTANT

Please record the following information for future service.

CODE	# _____	Four-digit number on outside of carton.
PACKER	# _____	See crystal package label.
ORDER	# _____	See crystal package label.

CAUTION: Glass parts are fragile. To Avoid breakage use care when assembling or cleaning.

1 MAKE SURE THAT POWER TO THE OUTLET BOX IS DISCONNECTED!!

2 Thread long screw "A" through crossbar "B" and attach crossbar to outlet box using 2 screws round head 8-32 x 1" (not supplied with wall bracket.)

3 Test fit wall bracket by guiding it over screw "A". Adjust screw "A" so that it extends approximately 1/4" through wall bracket. Remove wall bracket. Thread nut "C" onto screw and tighten it against crossbar. (NOTE: In some installations, due to space, nut "C" might have to go on the other side of the crossbar.)

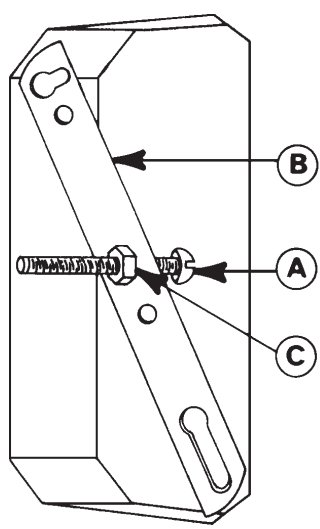

CENTER GLASS SCROLL #9615/1S

UPPER BOBECHE #9771

BACK PLATE COVER #9319

LOWER BOBECHE #9763/2/9930

LEFT GLASS ARM #9325/14S

RIGHT GLASS ARM #9325/15S

4 Turn arm to line up hole in arm with dimple in plate. Tighten lock washer and nut to secure arm in place.

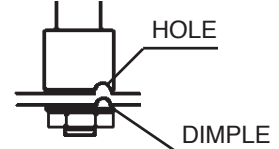

5 Connect the wires of the wall bracket to the power wires of the outlet box, guide wall bracket over screw "A" and secure with threaded half ball supplied. NOTE: Fixture MUST be grounded.

6 Install bobeches and screw bulb into all socket(s). Test power to insure proper wiring before hanging trim from fixture.



VIEW "A"

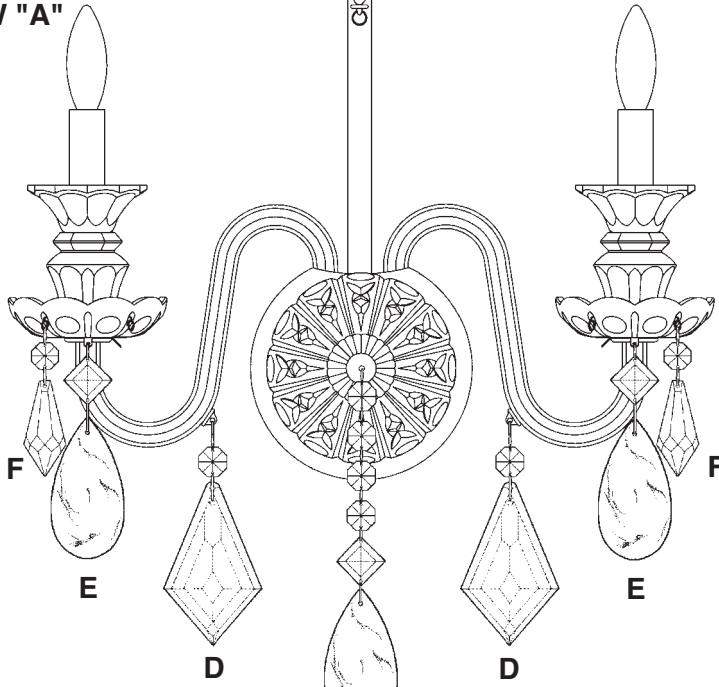

VIEW "B"

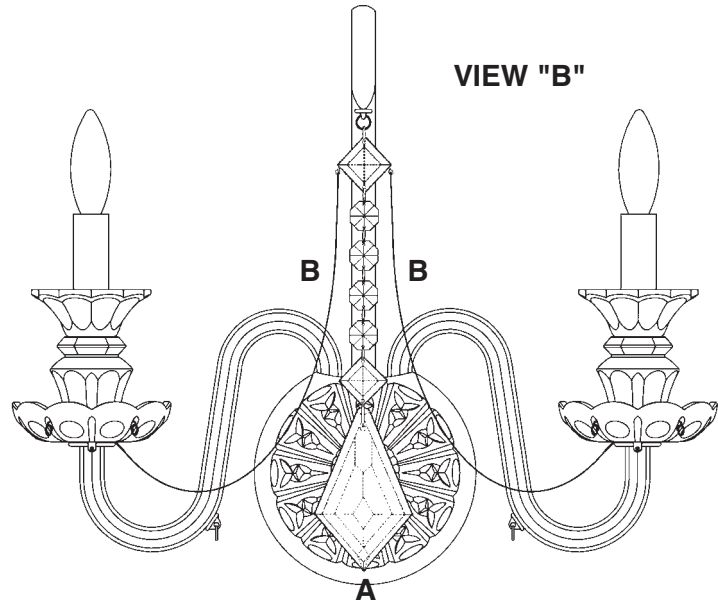

7 Hook Drop "C" into the pigtail on the center knob. See View "A".

8 Hook Drops "D" into the lower ring on the glass arms. See View "A".

9 Hook Drops "E" into the front tabs under the bobecche. See View "A".

10 Hook Drop "A" into the ring on the glass scroll. See View "B".

11 Hook Chains "B" into the rings of Drop "A". NOTE: Chains "B" should be hung in the following manner - at top, 8 octagons, 1 diamond, 3 octagons, at bottom. Hook the other end into the side tabs under the bobecche. Chains "B" are swagged between the Drop "A" and the glass arms. See View "B".

12 Every bobecche is trimmed with Drops "F", suspended from every ring between the scallops. See View "A".