

# CHANDELIER 5536AM TRIM DIAGRAM



**T**HIS DESIGN IS THE PROPRIETARY TRADE DRESS/TRADENAME OF W SCHONBEK LLC.

7 Lights  
Diameter: 24"  
Body Length: 32-1/2"



# SCHONBEK | 1870

**CAUTION... RISK OF ELECTRICAL SHOCK.** Make sure the electrical supply to the chandelier is turned off at the main fuse or circuit breaker before doing any installation. All electrical components must be installed by a licensed electrician in accordance with the National Electric Code and the appropriate local electrical codes.

HANGING WEIGHT: 27 pounds.

BULBS: 7 Candle shaped candelabra base B10 bulbs, recommend 25 watts for best appearance.  
60 Watt Maximum

WARNING: This chandelier meets UL/CSA requirements. Any tampering will void UL/CSA certification.

### MAINTENANCE:

Use a damp chamois to clean the glass frame.

**UNDER NO CIRCUMSTANCES SHOULD METAL POLISHES, CLEANERS, ABRASIVES OR AEROSOL SPRAYS BE USED.**

While the latest finishing techniques have been used on the metal frame, such finish cannot be unconditionally guaranteed. The main cause of deterioration, apart from certain atmospheric conditions, is improper cleaning.

To clean the crystals, polish with a soft, damp chamois.

You are cleaning delicate crystal... Take the greatest care.

### IMPORTANT:

Do not clean crystals in a dishwasher. The finish of the metal clips and hangers will be ruined and the crystals may be damaged.

**IMPORTANT**  
*Please record the following information for future service.*

CODE	#	_____	Four-digit number on outside of carton.
PACKER	#	_____	See crystal package label.
ORDER	#	_____	See crystal package label.

**CAUTION:** Glass parts are fragile. COLOR →  
To avoid breakage use care when assembling or cleaning.

### WHEN ORDERING REPLACEMENT ARM(S):

! Give arm number from trim diagram  
! Give color code from the arm itself

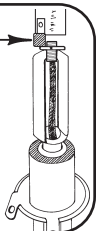

**1 MAKE SURE THAT POWER TO THE OUTLET BOX IS DISCONNECTED!! IMPORTANT: NEUTRAL WIRE IS WHITE GROUND WIRE IS BARE OR GREEN**

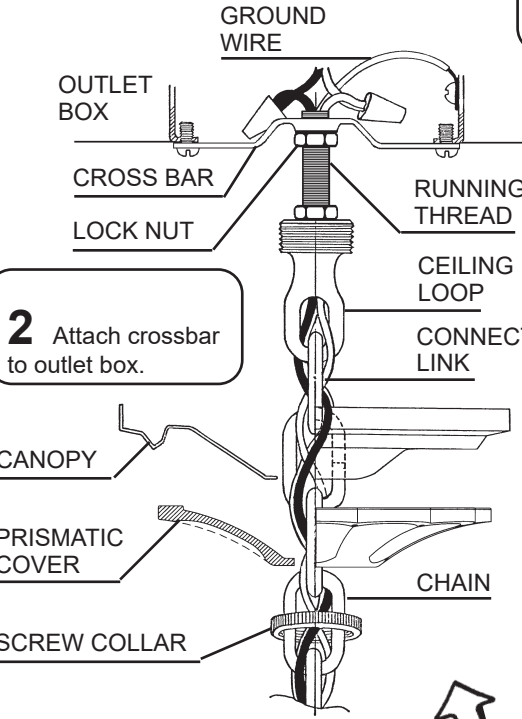

**2** Attach crossbar to outlet box.

**4** Insert stem wire through chain and ceiling loop. Connect wires in outlet box. Fixture MUST be grounded.

**5** Check distance from ceiling to loop to assure canopy assembly will be flush against ceiling.

**6** Attach canopy to ceiling with screw collar.

**3** Slip screw collar, prismatic cover and metal canopy over chain. Determine the suspension length of the fixture and cut chain, if necessary. Use two connecting links to attach chain to chandelier loop and ceiling loop.

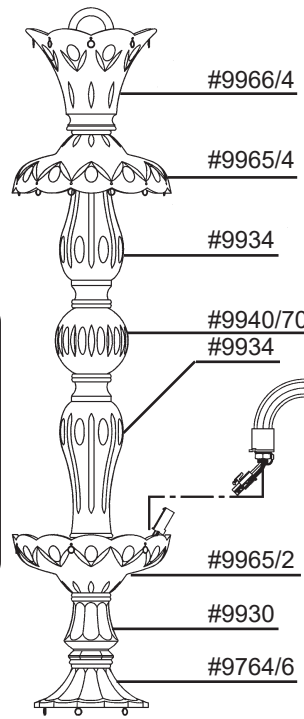

**7** Connect arm wires to the center column using plug-in connectors. See detailed illustration.

**8** Push wires into hole and attach arm to washer by rotating arm into place. Lock down by tightening screws into flange. See detailed illustration.

**9** Install bobèche, bulbs, connect power and test the fixture before trimming. If any of the bulbs do NOT light - DISCONNECT POWER. Double check the wire connections.



**10** Hook Crystal "A" into ring on the column dish #1.

**11** Hook Chain "C" into every other ring on the column dish #2. (NOTE: Make sure Chains "C" hang in between arms.) Hook Chain "D" into the loops of Chain "C". Hook the other ends of Chain "D" into the back tab under the bobèche on the arms.

**12** Hook Crystal "B" into every other ring on the column dish #2.

**19** Hook Crystal "A" into ring on bobèche.

**13** Screw Crystal Ball "E" onto the bottom of the frame. Tighten set screw with Allen wrench provided to lock ball into position.

**14** Hook Crystal "F" into rings on the column dish #4.

**15** Hook Crystal "G" into ring on the column dish #3.

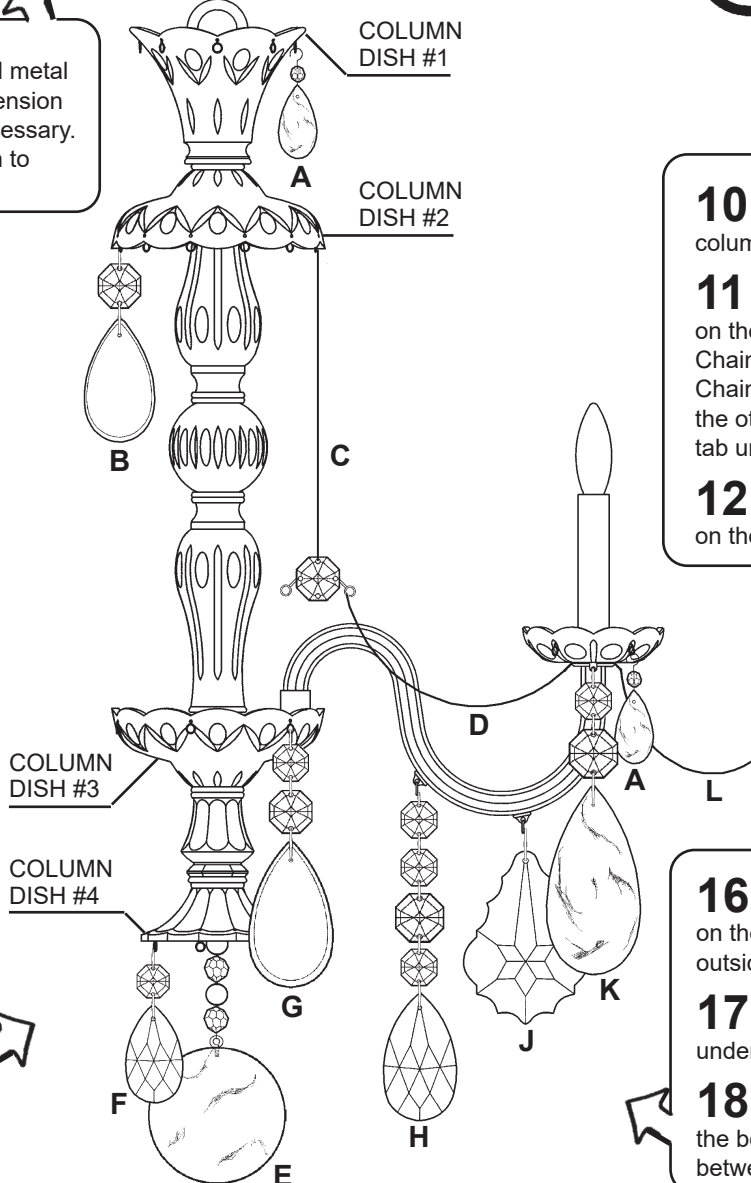

**16** Hook Crystal "H" into the inside rings on the lower arm. Hook Crystal "J" into the outside rings on the lower arm.

**17** Hook Crystal "K" into the front tab under the bobèche on the arm.

**18** Hook Chain "L" into the side tab under the bobèche on the arm. Chain "L" swags between arms.

# CHANDELIER 5536BK TRIM DIAGRAM

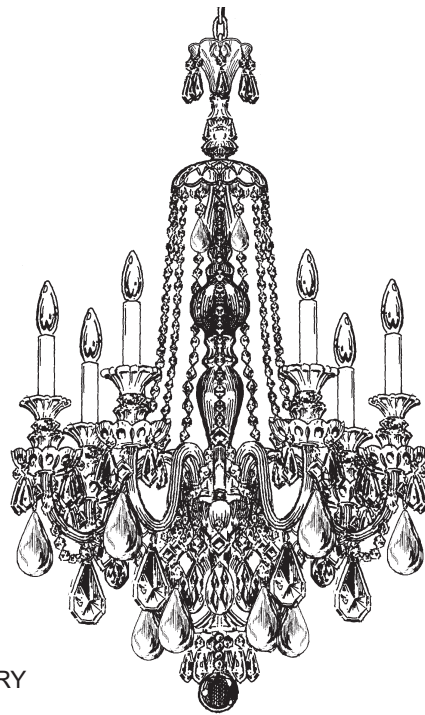

**T**HIS DESIGN IS THE PROPRIETARY TRADE DRESS/TRADEMARK OF W SCHONBEK LLC.

7 Lights  
Diameter: 24"  
Body Length: 31"



# SCHONBEK | 1870

**CAUTION... RISK OF ELECTRICAL SHOCK.** Make sure the electrical supply to the chandelier is turned off at the main fuse or circuit breaker before doing any installation. All electrical components must be installed by a licensed electrician in accordance with the National Electric Code and the appropriate local electrical codes.

HANGING WEIGHT: 27 pounds.

BULBS: 7 Candle shaped candelabra base B10 bulbs, recommend 25 watts for best appearance.  
60 Watt Maximum

WARNING: This chandelier meets UL/CSA requirements. Any tampering will void UL/CSA certification.

### MAINTENANCE:

Use a damp chamois to clean the glass frame.

**UNDER NO CIRCUMSTANCES SHOULD METAL POLISHES, CLEANERS, ABRASIVES OR AEROSOL SPRAYS BE USED.**

While the latest finishing techniques have been used on the metal frame, such finish cannot be unconditionally guaranteed. The main cause of deterioration, apart from certain atmospheric conditions, is improper cleaning.

To clean the crystals, polish with a soft, damp chamois.

You are cleaning delicate crystal... Take the greatest care.

### IMPORTANT:

Do not clean crystals in a dishwasher. The finish of the metal clips and hangers will be ruined and the crystals may be damaged.

**IMPORTANT**  
*Please record the following information for future service.*

CODE	#	_____	Four-digit number on outside of carton.
PACKER	#	_____	See crystal package label.
ORDER	#	_____	See crystal package label.

**CAUTION:** Glass parts are fragile. COLOR →  
To avoid breakage use care when assembling or cleaning.

### WHEN ORDERING REPLACEMENT ARM(S):

! Give arm number from trim diagram  
! Give color code from the arm itself

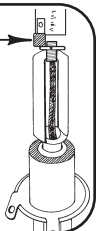

**1 MAKE SURE THAT POWER TO THE OUTLET BOX IS DISCONNECTED!! IMPORTANT: NEUTRAL WIRE IS WHITE GROUND WIRE IS BARE OR GREEN**

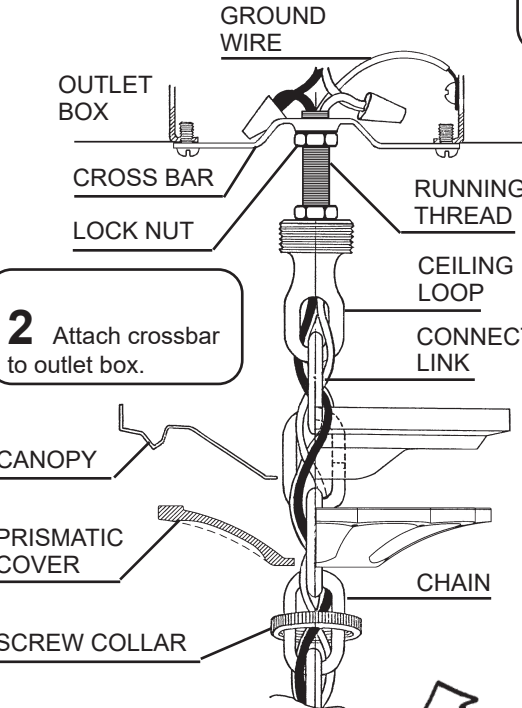

**2** Attach crossbar to outlet box.

**4** Insert stem wire through chain and ceiling loop. Connect wires in outlet box. Fixture MUST be grounded.

**5** Check distance from ceiling to loop to assure canopy assembly will be flush against ceiling.

**6** Attach canopy to ceiling with screw collar.

**3** Slip screw collar, prismatic cover and metal canopy over chain. Determine the suspension length of the fixture and cut chain, if necessary. Use two connecting links to attach chain to chandelier loop and ceiling loop.

SCHONBEK IS A WORLD LEADER IN CHANDELIER DESIGN. PATENTS INCLUDE: 5,460,269 & 5,873,652

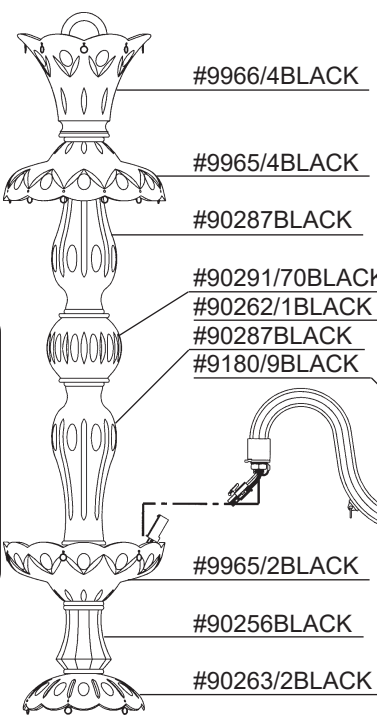

**7** Connect arm wires to the center column using plug-in connectors. See detailed illustration.

**8** Push wires into hole and attach arm to washer by rotating arm into place. Lock down by tightening screws into flange. See detailed illustration.

**9** Install bobèche, bulbs, connect power and test the fixture before trimming. If any of the bulbs do NOT light - DISCONNECT POWER. Double check the wire connections.



**10** Hook Crystal "A" into ring on the column dish #1.

**11** Hook Chain "C" into every other ring on the column dish #2. (NOTE: Make sure Chains "C" hang in between arms.) Hook Chain "D" into the loops of Chain "C". Hook the other ends of Chain "D" into the back tab under the bobèche on the arms.

**12** Hook Crystal "B" into every other ring on the column dish #2.

**19** Hook Crystal "A" into ring on bobèche.

**13** Screw Crystal Ball "E" onto the bottom of the frame. Tighten set screw with Allen wrench provided to lock ball into position.

**14** Hook Crystal "A" into rings on the column dish #4.

**15** Hook Crystal "F" into ring on the column dish #3.

**16** Hook Crystal "G" into the inside rings on the lower arm. Hook Crystal "H" into the outside rings on the lower arm.

**17** Hook Crystal "J" into the front tab under the bobèche on the arm.

**18** Hook Chain "K" into the side tab under the bobèche on the arm. Chain "K" swags between arms.

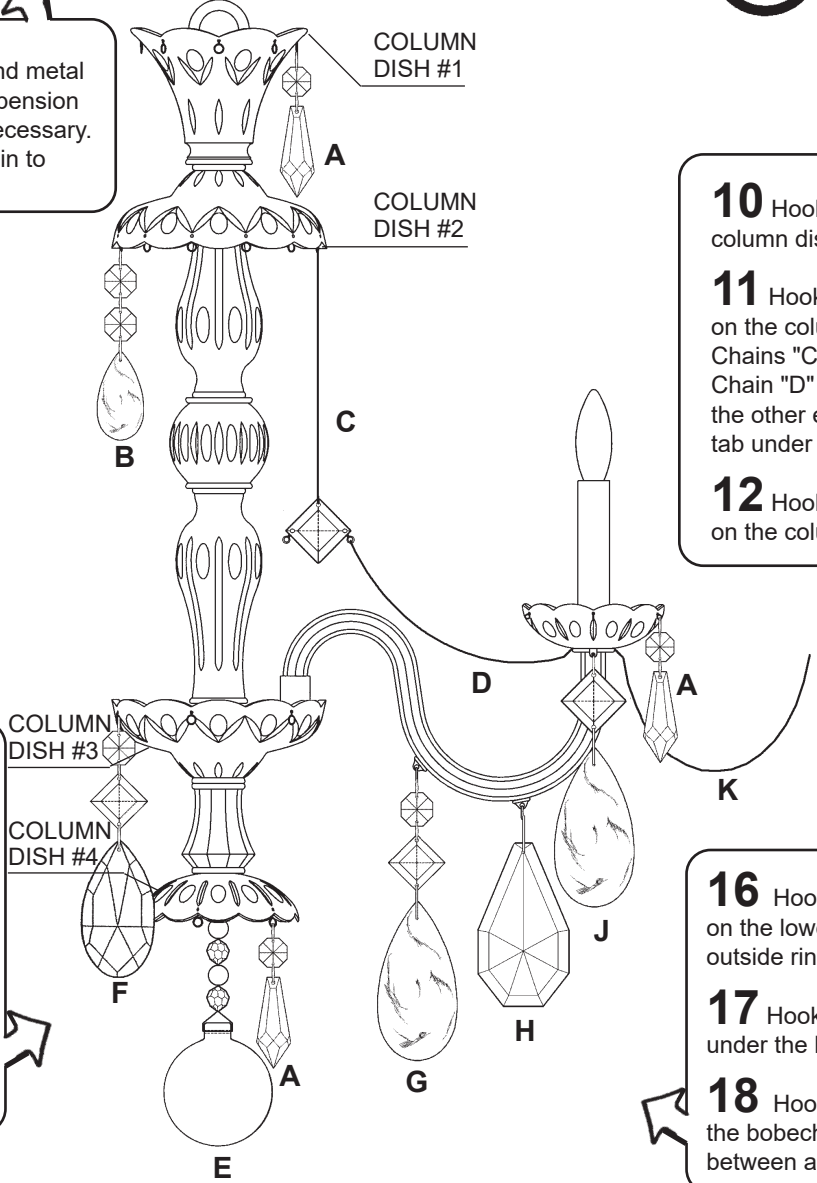

# CHANDELIER 5536CL TRIM DIAGRAM

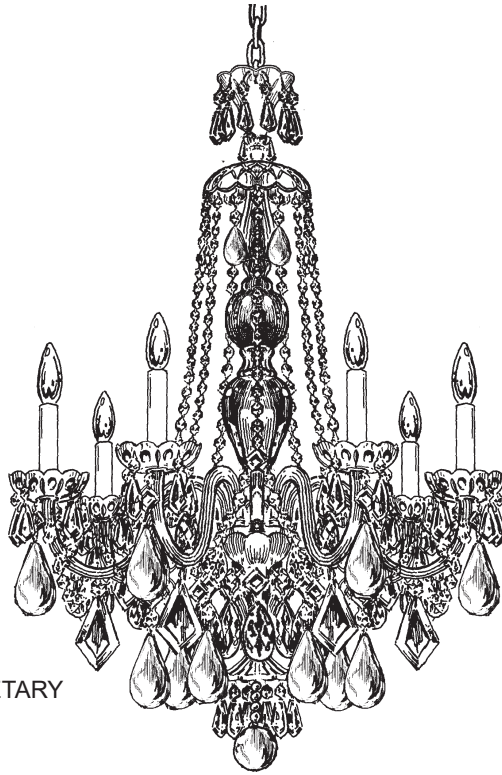

**T**HIS DESIGN IS THE PROPRIETARY TRADE DRESS/TRADEMARK OF W SCHONBEK LLC.

7 Lights  
Diameter: 24"  
Body Length: 31-1/2"



# SCHONBEK | 1870

**CAUTION... RISK OF ELECTRICAL SHOCK.** Make sure the electrical supply to the chandelier is turned off at the main fuse or circuit breaker before doing any installation. All electrical components must be installed by a licensed electrician in accordance with the National Electric Code and the appropriate local electrical codes.

HANGING WEIGHT: 27 pounds.

BULBS: 7 Candle shaped candelabra base B10 bulbs, recommend 25 watts for best appearance.  
60 Watt Maximum

**WARNING:** This chandelier meets UL/CSA requirements. Any tampering will void UL/CSA certification.

### MAINTENANCE:

Use a damp chamois to clean the glass frame.

**UNDER NO CIRCUMSTANCES SHOULD METAL POLISHES, CLEANERS, ABRASIVES OR AEROSOL SPRAYS BE USED.**

While the latest finishing techniques have been used on the metal frame, such finish cannot be unconditionally guaranteed. The main cause of deterioration, apart from certain atmospheric conditions, is improper cleaning.

To clean the crystals, polish with a soft, damp chamois.

You are cleaning delicate crystal... Take the greatest care.

### IMPORTANT:

Do not clean crystals in a dishwasher. The finish of the metal clips and hangers will be ruined and the crystals may be damaged.

**IMPORTANT**  
*Please record the following information for future service.*

CODE	#	_____	Four-digit number on outside of carton.
PACKER	#	_____	See crystal package label.
ORDER	#	_____	See crystal package label.

**CAUTION:** Glass parts are fragile. COLOR →  
To avoid breakage use care when assembling or cleaning.

**WHEN ORDERING REPLACEMENT ARM(S):**

! Give arm number from trim diagram  
! Give color code from the arm itself

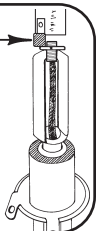

**1 MAKE SURE THAT POWER TO THE OUTLET BOX IS DISCONNECTED!! IMPORTANT: NEUTRAL WIRE IS WHITE GROUND WIRE IS BARE OR GREEN**

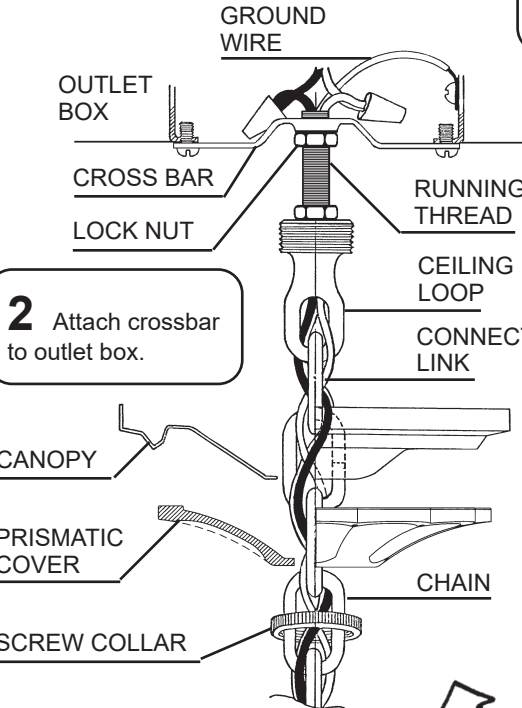

**2** Attach crossbar to outlet box.

**4** Insert stem wire through chain and ceiling loop. Connect wires in outlet box. Fixture MUST be grounded.

**5** Check distance from ceiling to loop to assure canopy assembly will be flush against ceiling.

**6** Attach canopy to ceiling with screw collar.

**3** Slip screw collar, prismatic cover and metal canopy over chain. Determine the suspension length of the fixture and cut chain, if necessary. Use two connecting links to attach chain to chandelier loop and ceiling loop.

SCHONBEK IS A WORLD LEADER IN CHANDELIER DESIGN. PATENTS INCLUDE: 5,460,269 & 5,873,652

**13** Screw Crystal Ball "E" onto the bottom of the frame. Tighten set screw with Allen wrench provided to lock ball into position.

**14** Hook Crystal "A" into rings on the column dish #4.

**15** Hook Crystal "F" into ring on the column dish #3.

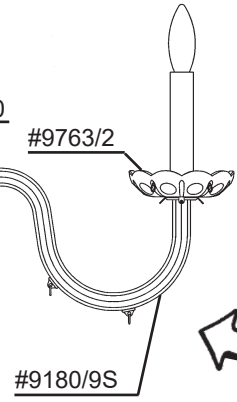
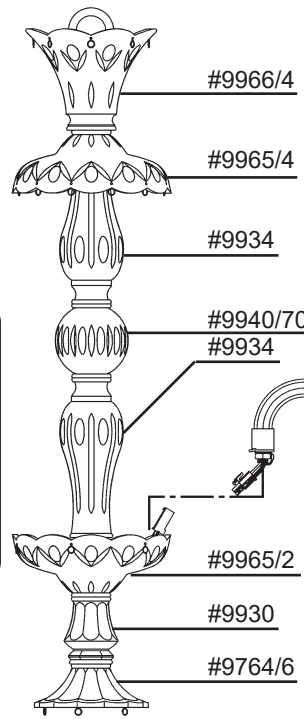

**7** Connect arm wires to the center column using plug-in connectors. See detailed illustration.

**8** Push wires into hole and attach arm to washer by rotating arm into place. Lock down by tightening screws into flange. See detailed illustration.

**9** Install bobèche, bulbs, connect power and test the fixture before trimming. If any of the bulbs do NOT light - DISCONNECT POWER. Double check the wire connections.



**10** Hook Crystal "A" into ring on the column dish #1.

**11** Hook Chain "C" into every other ring on the column dish #2. (NOTE: Make sure Chains "C" hang in between arms.) Hook Chain "D" into the loops of Chain "C". Hook the other ends of Chain "D" into the back tab under the bobèche on the arms.

**12** Hook Crystal "B" into every other ring on the column dish #2.

**19** Hook Crystal "A" into ring on bobèche.

**16** Hook Crystal "G" into the inside rings on the lower arm. Hook Crystal "H" into the outside rings on the lower arm.

**17** Hook Crystal "J" into the front tab under the bobèche on the arm.

**18** Hook Chain "K" into the side tab under the bobèche on the arm. Chain "K" swags between arms.

