

 **SCHONBEK** | 1870











MILANO 5642- ___ H



THIS DESIGN IS THE PROPRIETARY TRADE DRESS/TRADEMARK OF W SCHONBEK LLC.

2 Light
Diameter: 13-1/2"
Body Length: 15-1/2"
Extension: 7-1/2"
Hanging Weight: 3 lbs.

 **SCHONBEK** | 1870

								
MAX 60 W		110-120 V						

All electrical components must be installed by a licensed electrician in accordance with the National Electric Code and the appropriate local electrical codes.

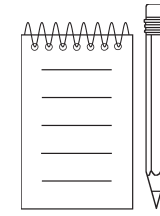
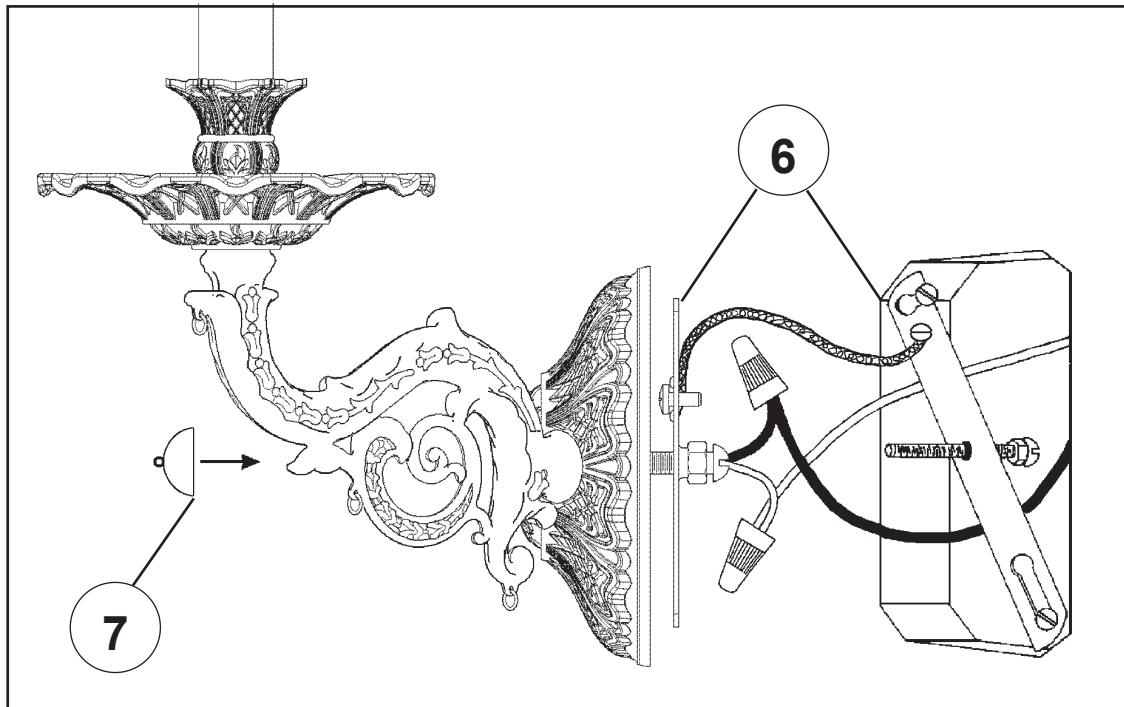
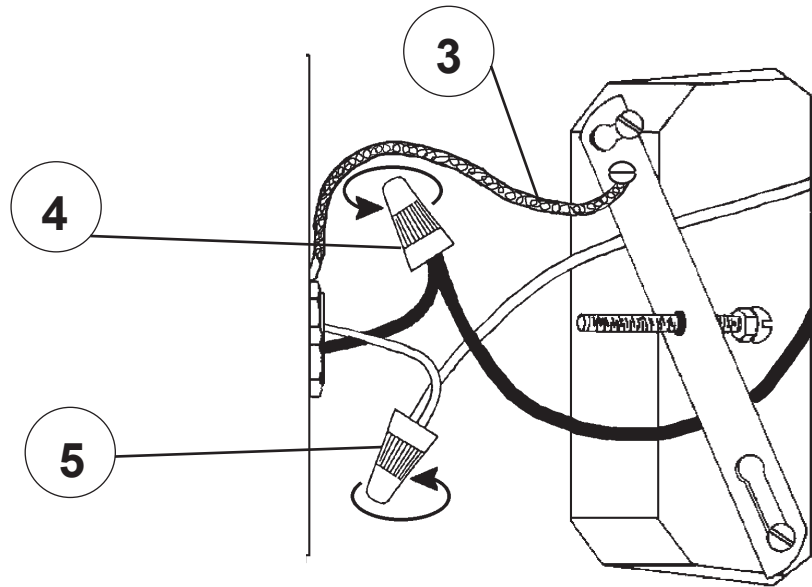
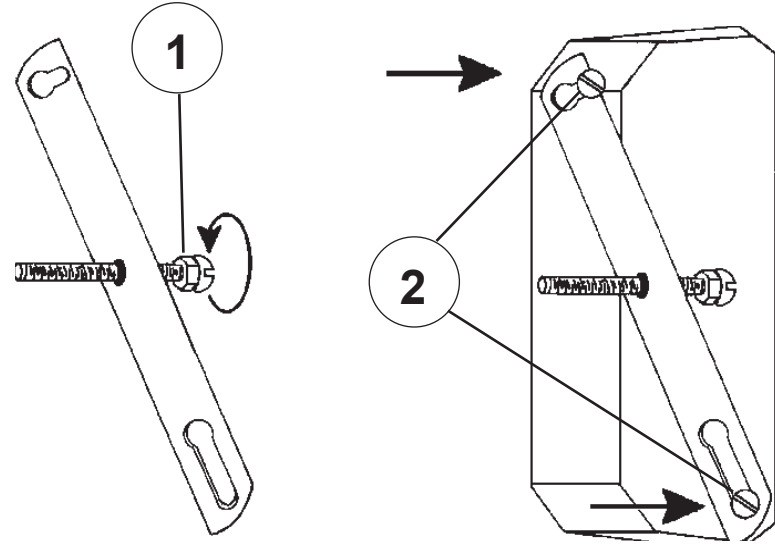



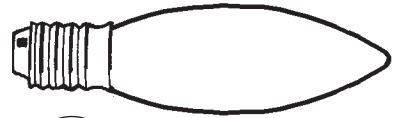

8

You will need 2 - B10
25 Watts Recommended
60 Watts Max

Install bulb and be sure
to test fixture **BEFORE**
trimming.

DIAGRAM #1

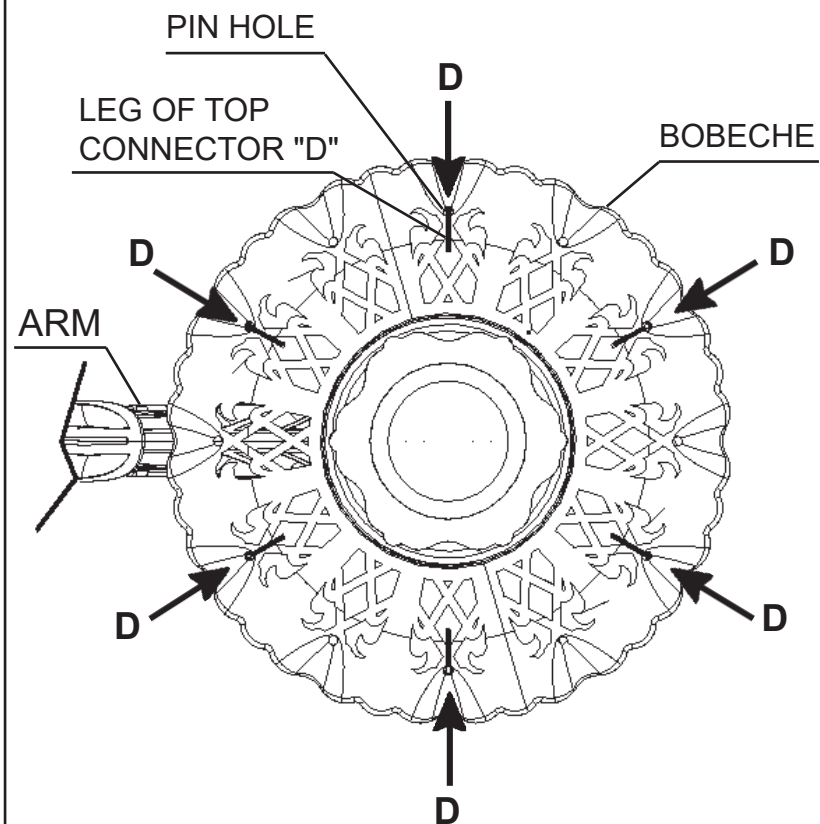

When trimming bobeche with letter "D", insert leg of top connector into pin hole from under bobeche. Hang in every other pin hole starting on either side of the arm (refer to Diagram #1)

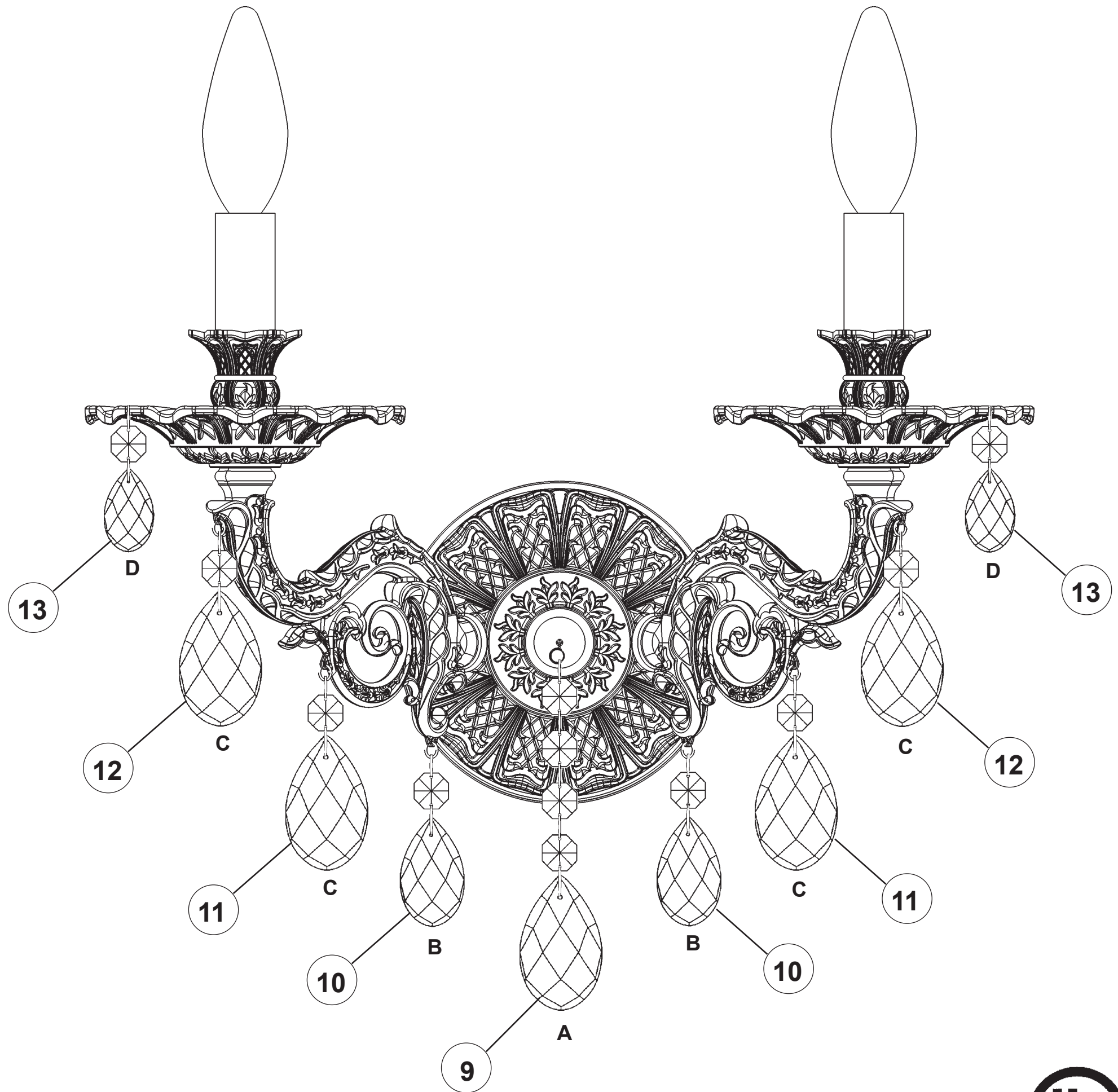

 **SCHONBEK** | 1870











MILANO 5642- __ __ R



THIS DESIGN IS THE PROPRIETARY TRADE DRESS/TRADEMARK OF W SCHONBEK LLC.

2 Light
Diameter: 13-1/2"
Body Length: 15-1/2"
Extension: 7-1/2"
Hanging Weight: 3 lbs.

 **SCHONBEK** | 1870

								
MAX 60 W		110-120 V						

All electrical components must be installed by a licensed electrician in accordance with the National Electric Code and the appropriate local electrical codes.

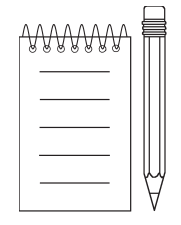
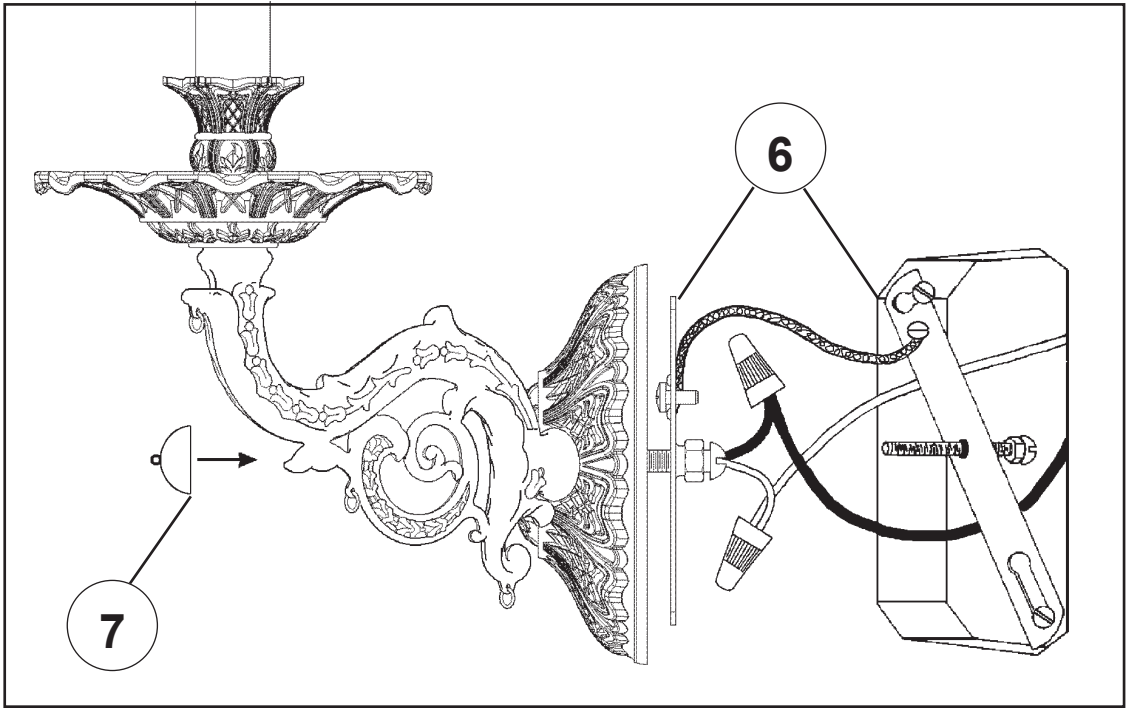
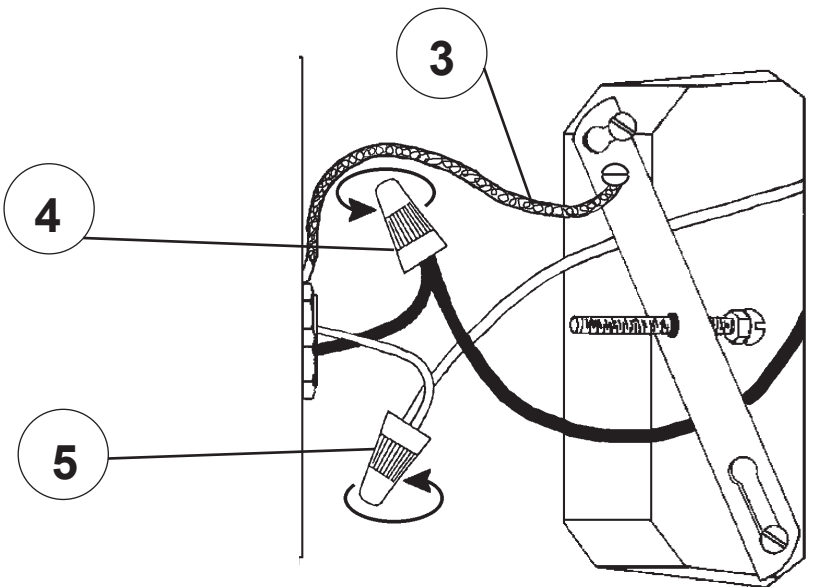
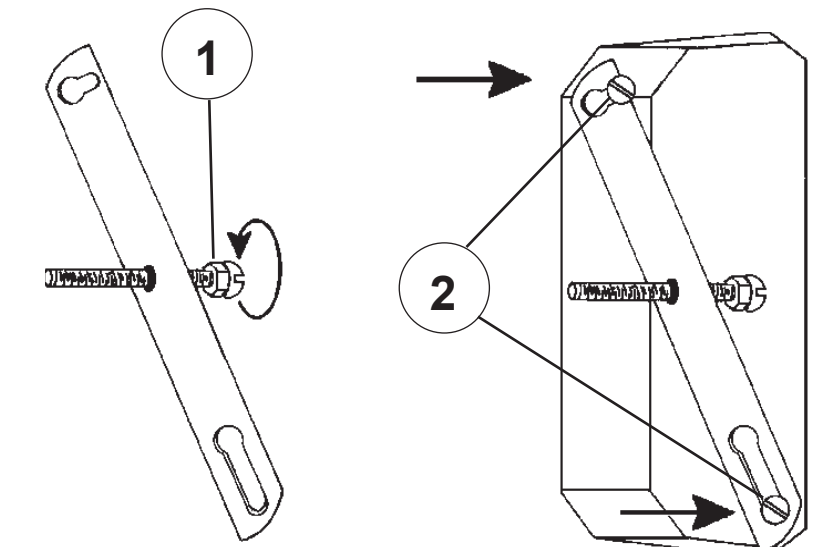

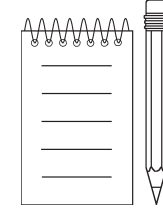
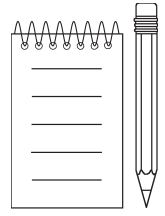

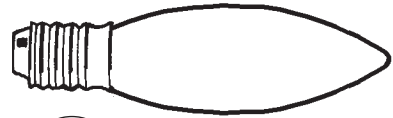

8

You will need 2 - B10
25 Watts Recommended
60 Watts Max

Install bulb and be sure
to test fixture BEFORE
trimming.

DIAGRAM #1

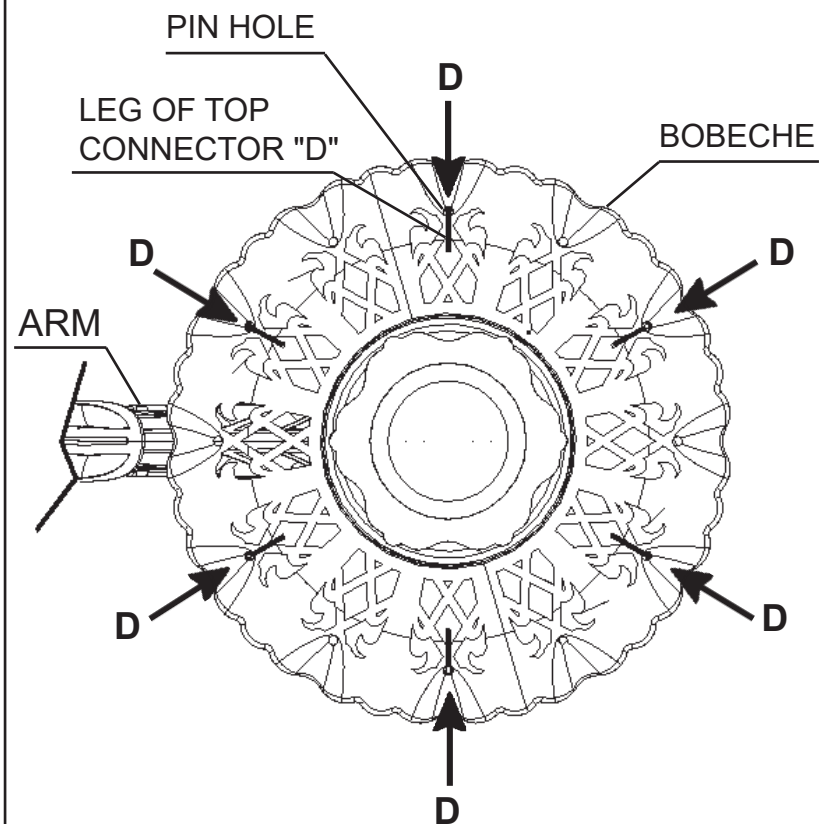

When trimming bobeche with letter "D", insert leg of top connector into pin hole from under bobeche. Hang in every other pin hole starting on either side of the arm (refer to Diagram #1)

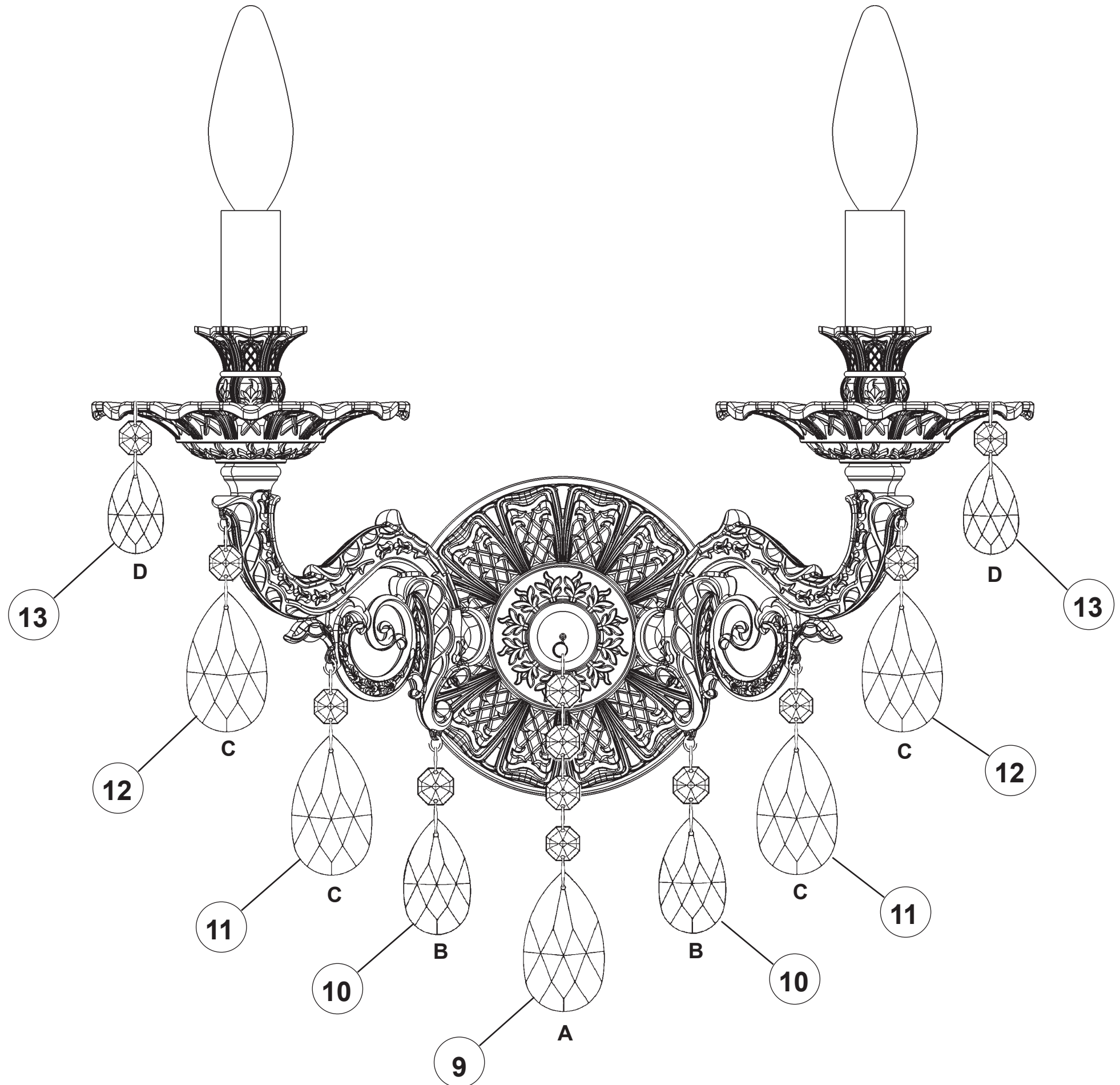

 **SCHONBEK** | 1870











MILANO 5642- _____



THIS DESIGN IS THE PROPRIETARY TRADE DRESS/TRADEMARK OF W SCHONBEK LLC.

2 Light
Diameter: 13-1/2"
Body Length: 15-1/2"
Extension: 7-1/2"
Hanging Weight: 3 lbs.

 **SCHONBEK** | 1870

								
MAX 60 W	110-120 V							

All electrical components must be installed by a licensed electrician in accordance with the National Electric Code and the appropriate local electrical codes.

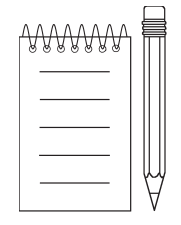
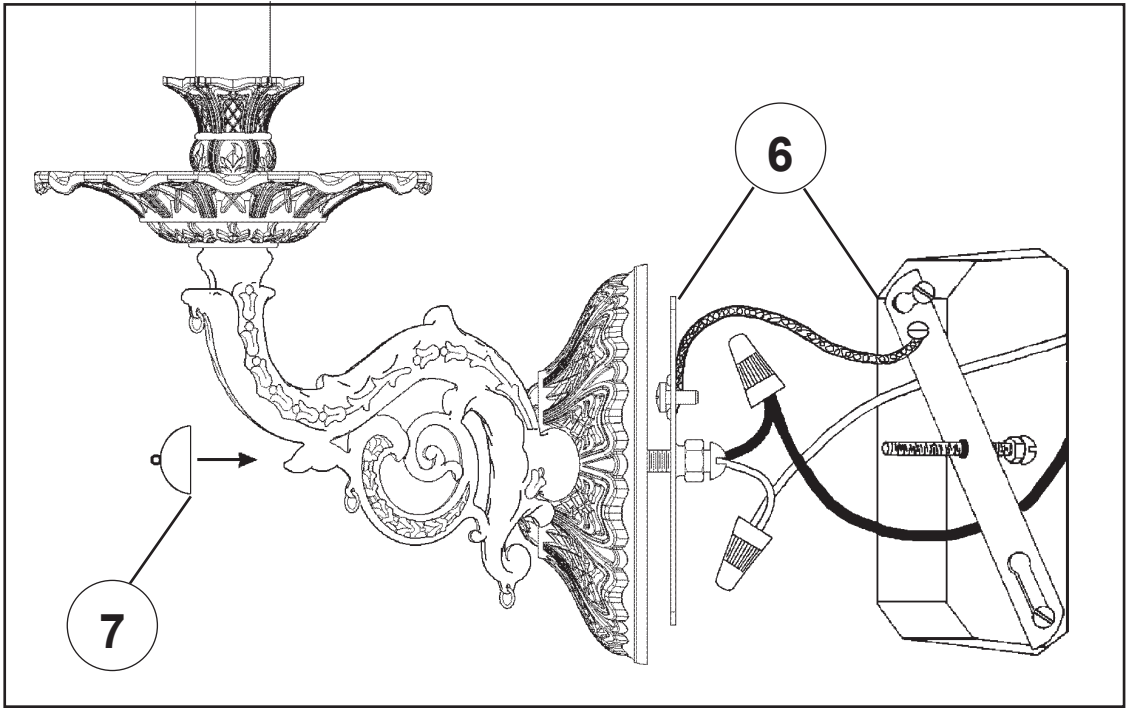
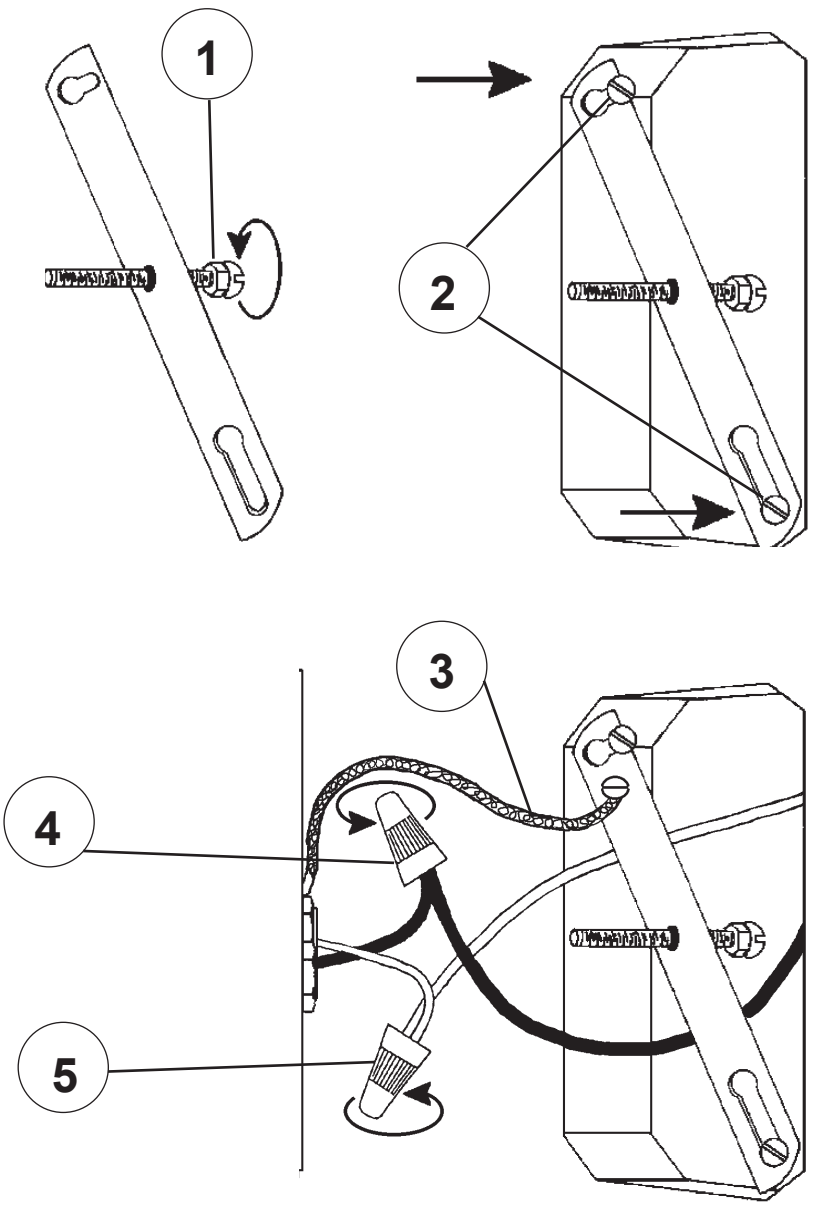



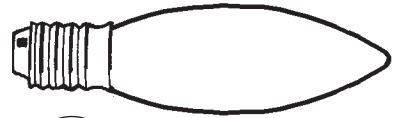

8

You will need 2 - B10
25 Watts Recommended
60 Watts Max

Install bulb and be sure
to test fixture **BEFORE**
trimming.

DIAGRAM #1

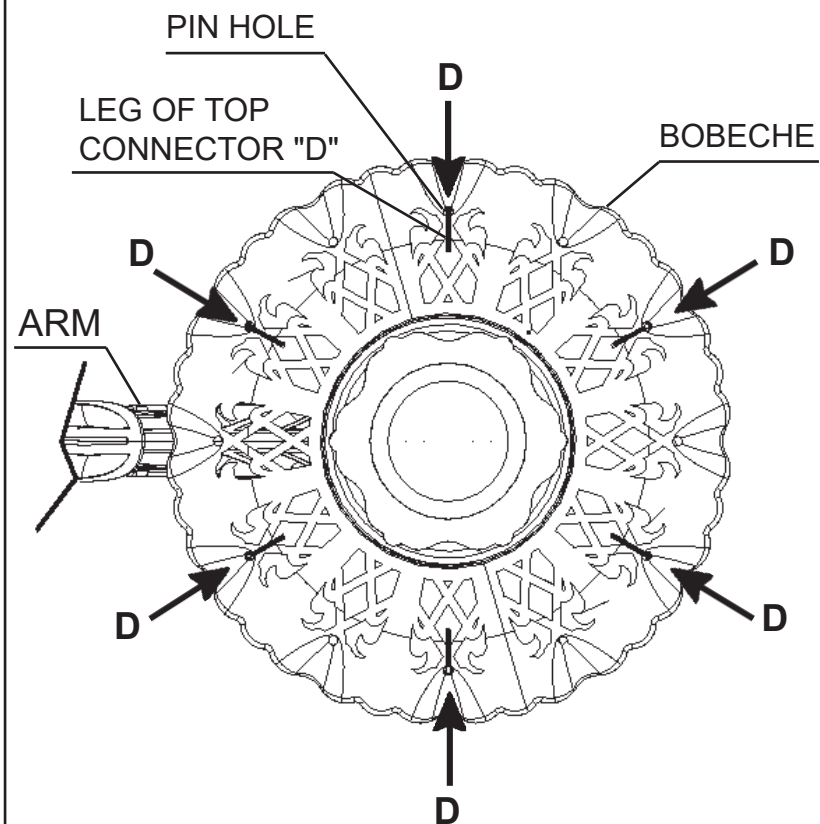

When trimming bobeche with letter "D", insert leg of top connector into pin hole from under bobeche. Hang in every other pin hole starting on either side of the arm (refer to Diagram #1)

