

 **SCHONBEK** | 1870











MILANO 5643- \_\_\_ \_H



3 Lights  
Diameter: 13"  
Body Length: 15"  
Extension: 8-1/2"  
Hanging Weight: 3 lbs.

**T**HIS DESIGN IS THE PROPRIETARY TRADE DRESS/TRADEMARK OF W SCHONBEK LLC.

 **SCHONBEK** | 1870

								
MAX <b>60</b> W		110-120 V						

All electrical components must be installed by a licensed electrician in accordance with the National Electric Code and the appropriate local electrical codes.

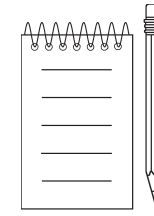
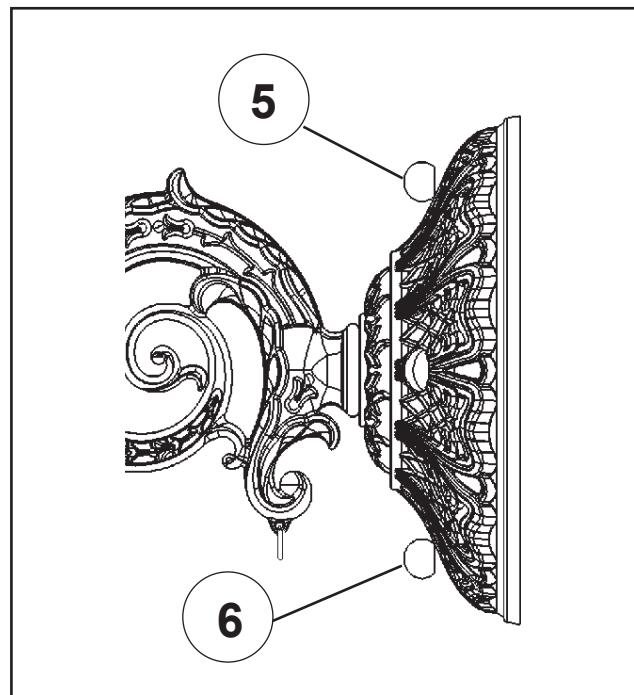
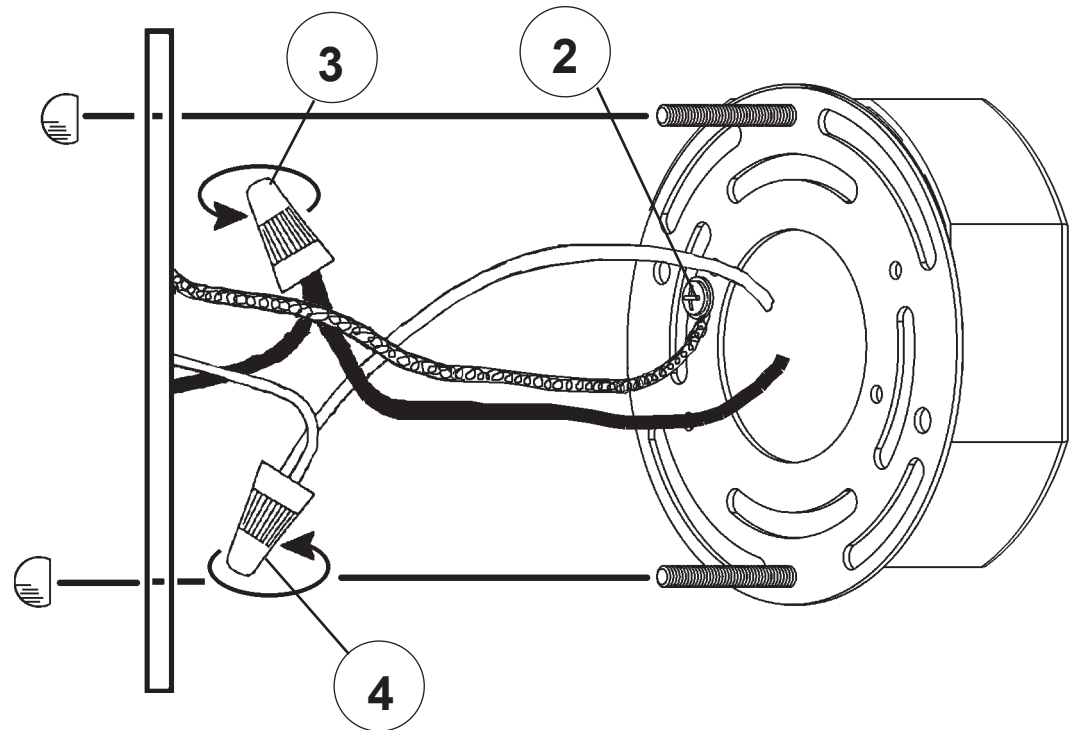
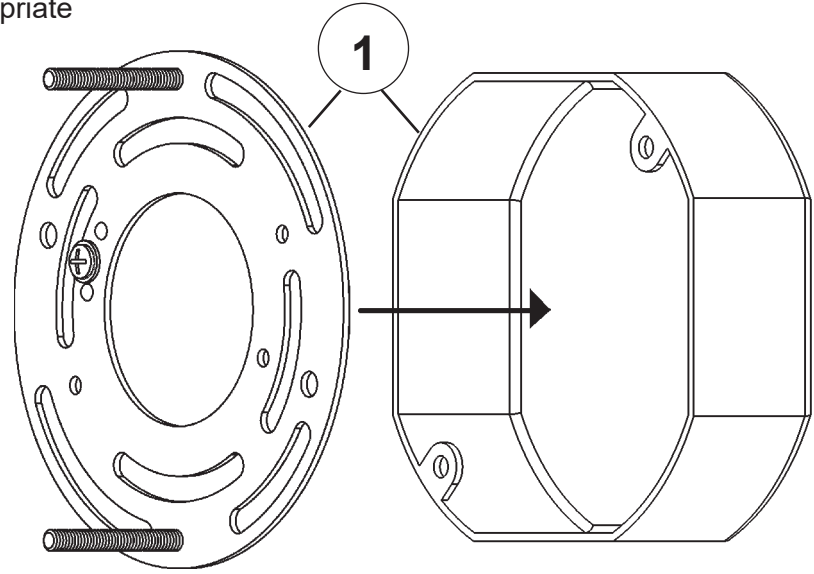

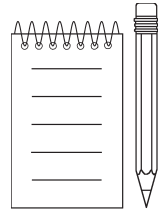

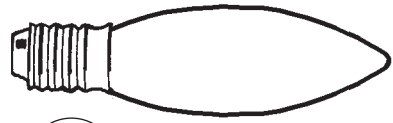

7

You will need 3 - B10  
25 Watts Recommended  
60 Watts Max

Install bulb and be sure  
to test fixture **BEFORE**  
trimming.

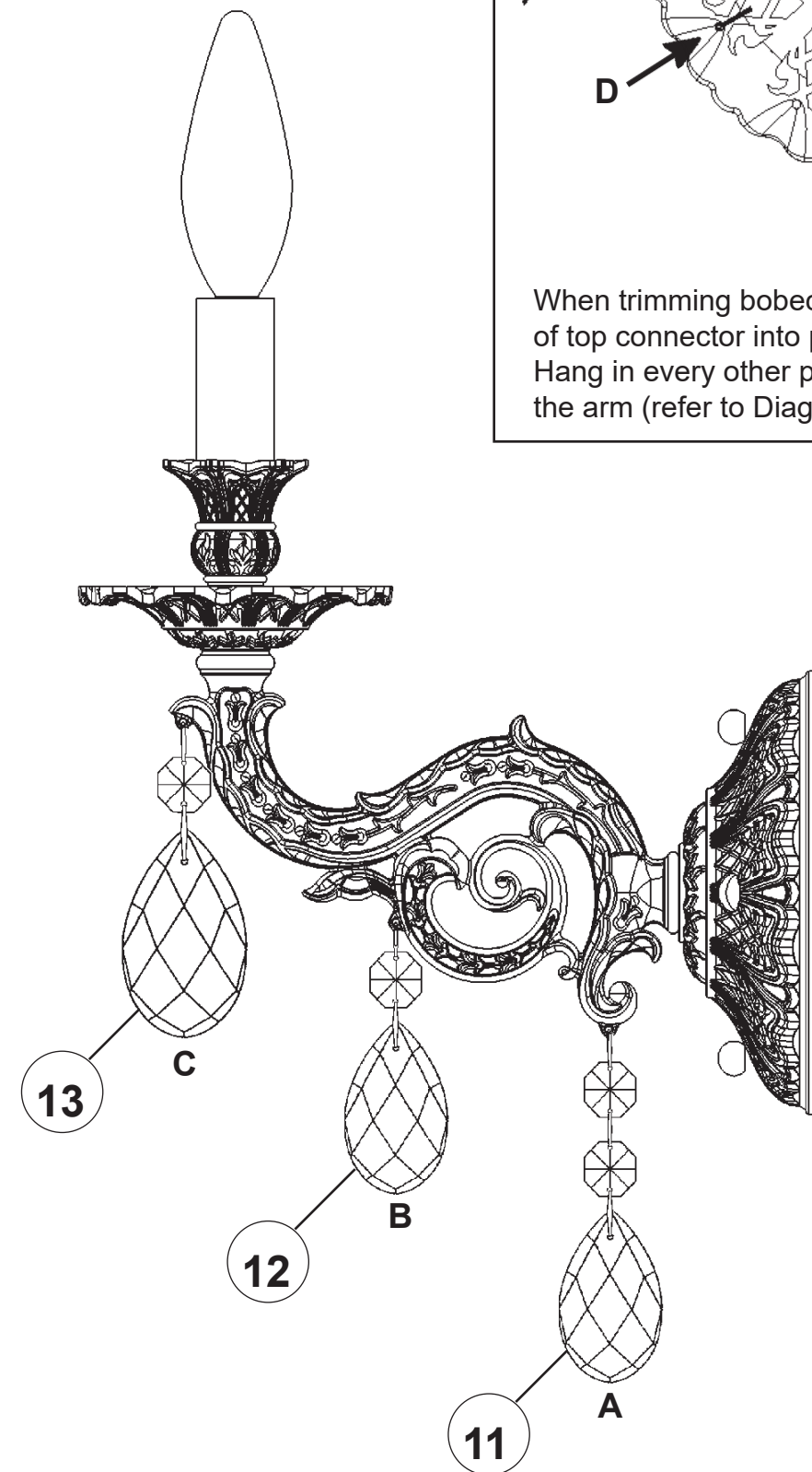
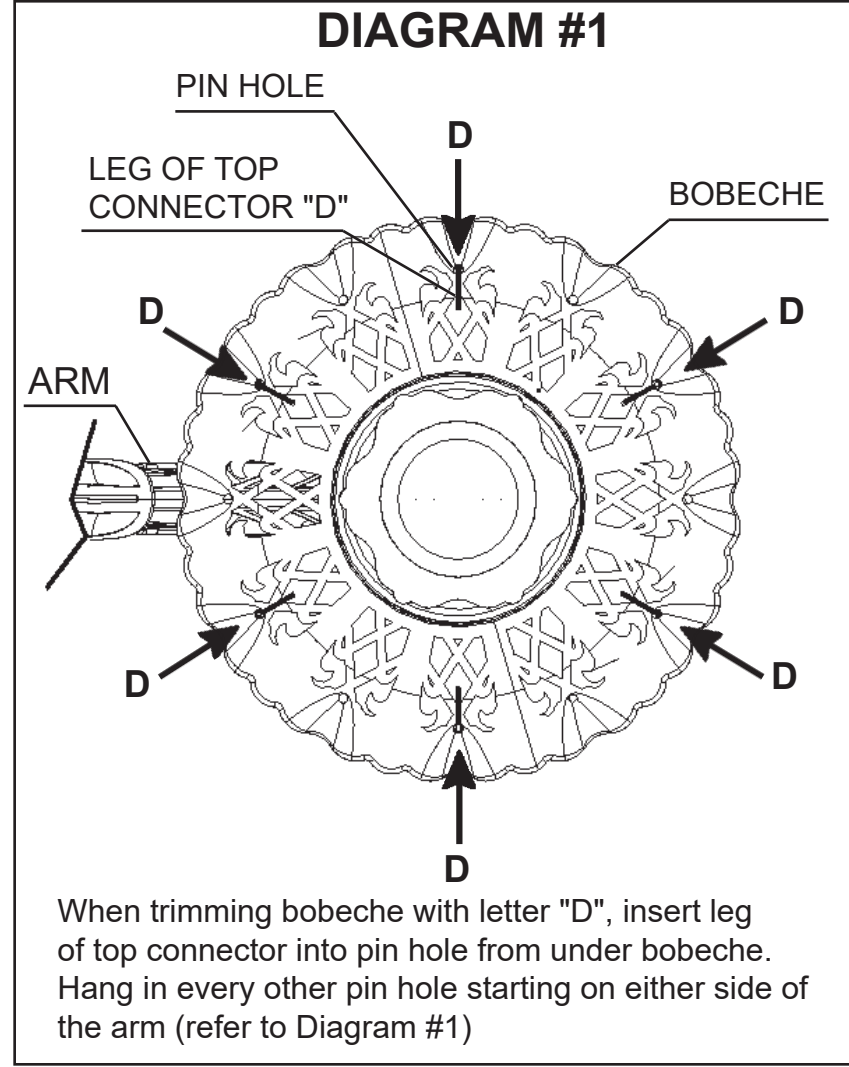
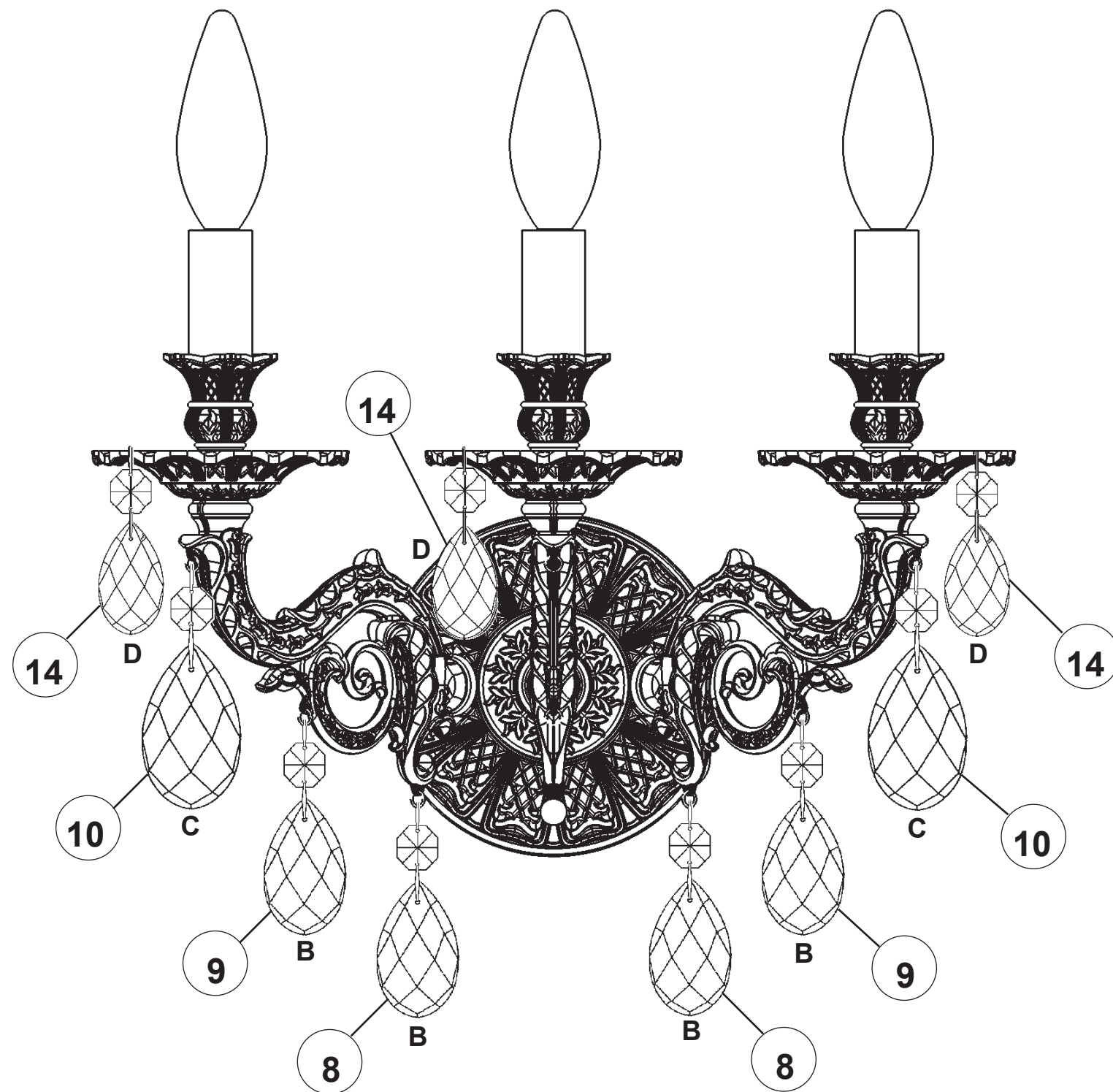

 **SCHONBEK** | 1870



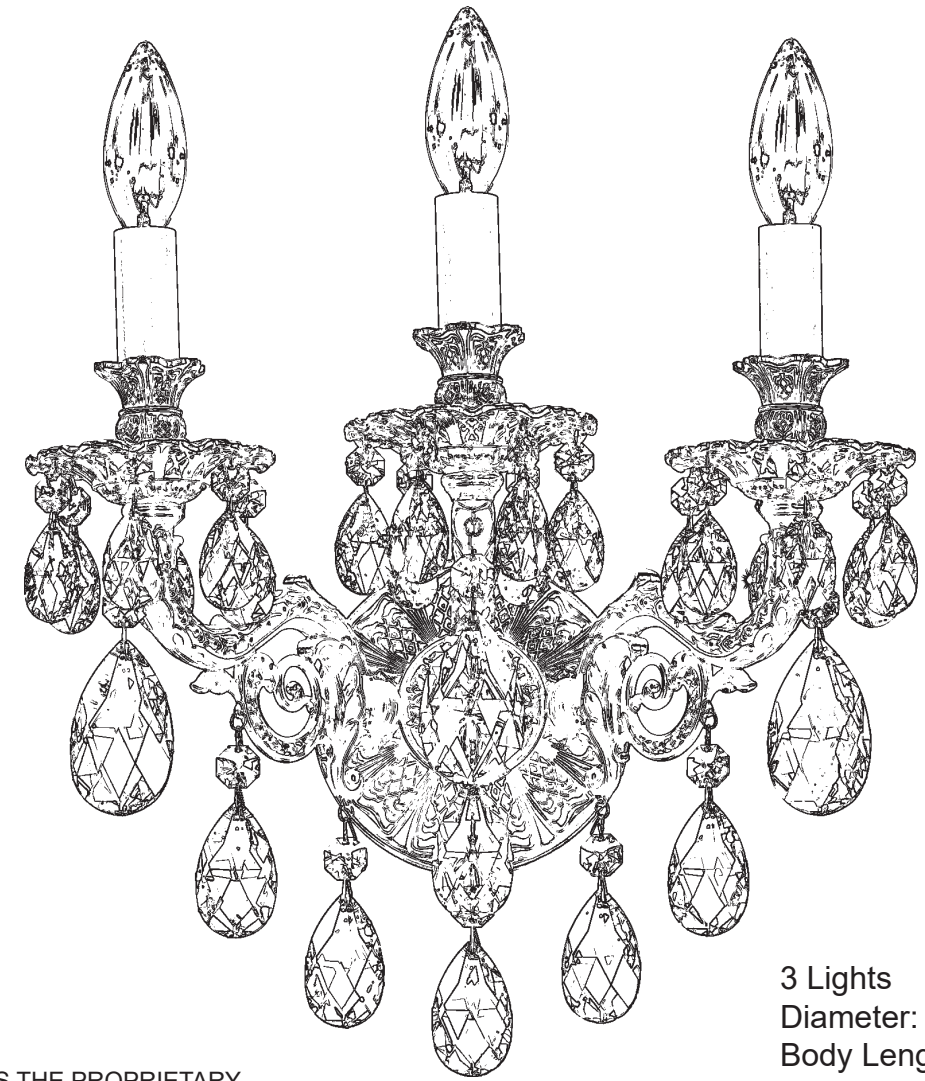







# MILANO 5643- \_\_\_ \_R



**T**HIS DESIGN IS THE PROPRIETARY TRADE DRESS/TRADEMARK OF W SCHONBEK LLC.

3 Lights  
Diameter: 13"  
Body Length: 15"  
Extension: 8-1/2"  
Hanging Weight: 3 lbs.

 **SCHONBEK** | 1870

								
MAX <b>60</b> W		110-120 V						



All electrical components must be installed by a licensed electrician in accordance with the National Electric Code and the appropriate local electrical codes.

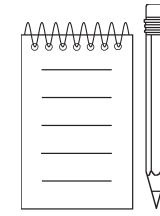
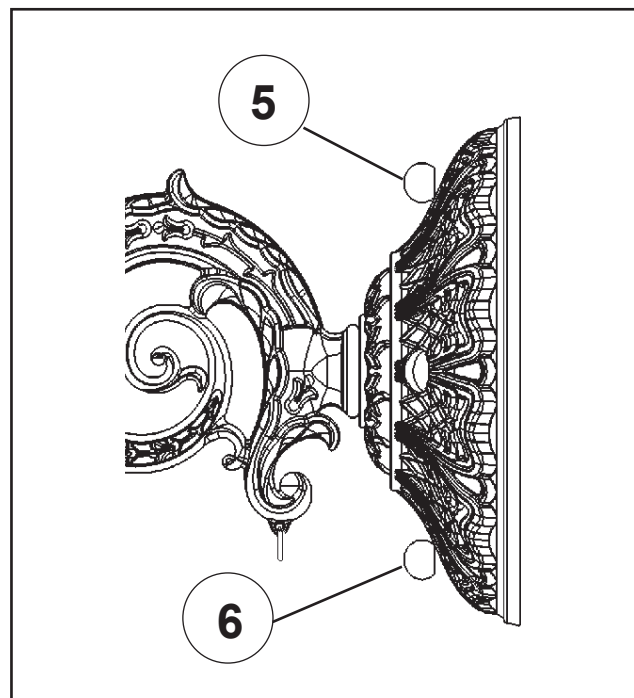
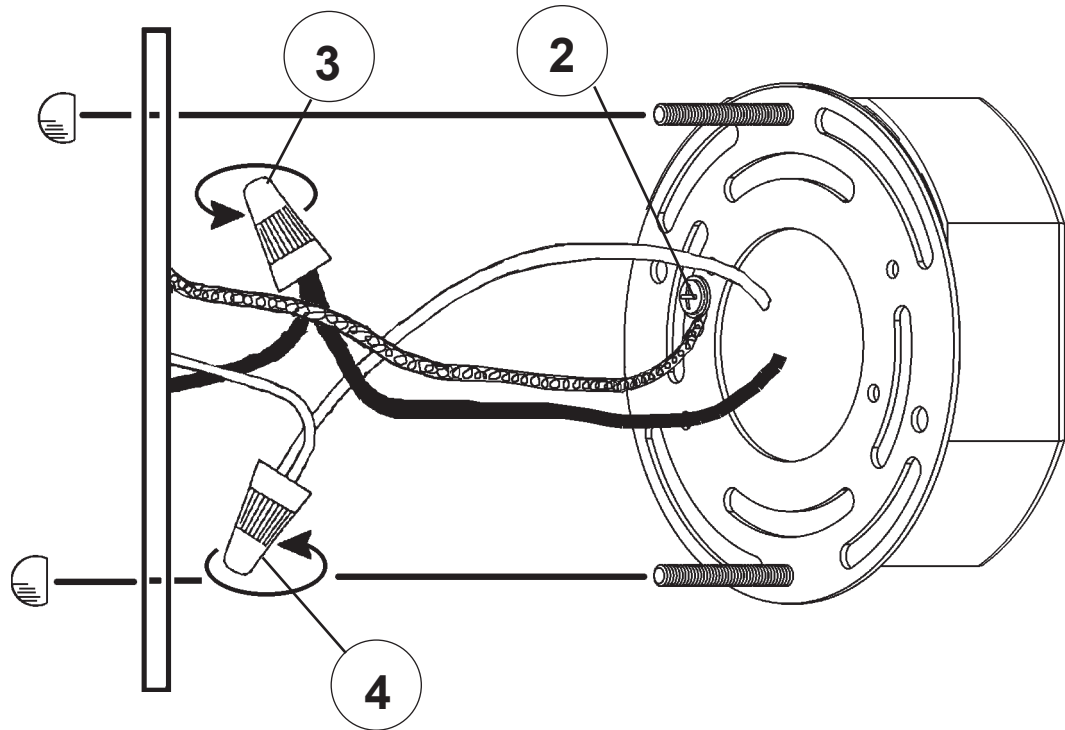
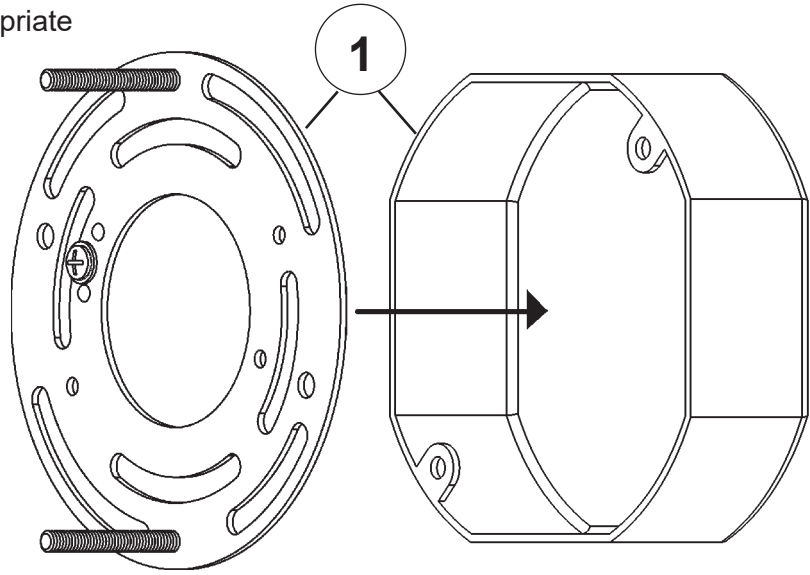

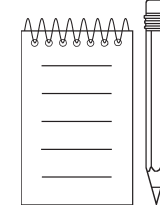
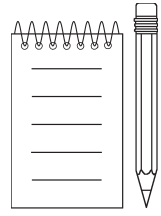

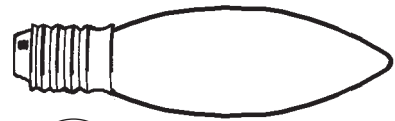

7

You will need 3 - B10  
25 Watts Recommended  
60 Watts Max

Install bulb and be sure  
to test fixture BEFORE  
trimming.

### DIAGRAM #1

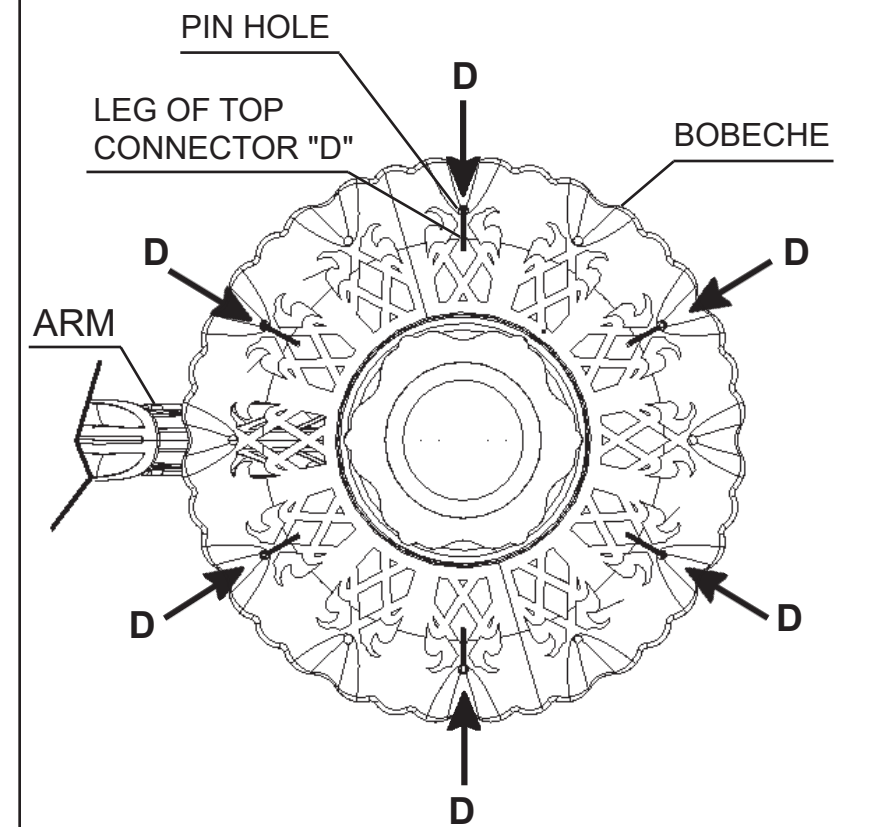

When trimming bobèche with letter "D", insert leg of top connector into pin hole from under bobèche. Hang in every other pin hole starting on either side of the arm (refer to Diagram #1)

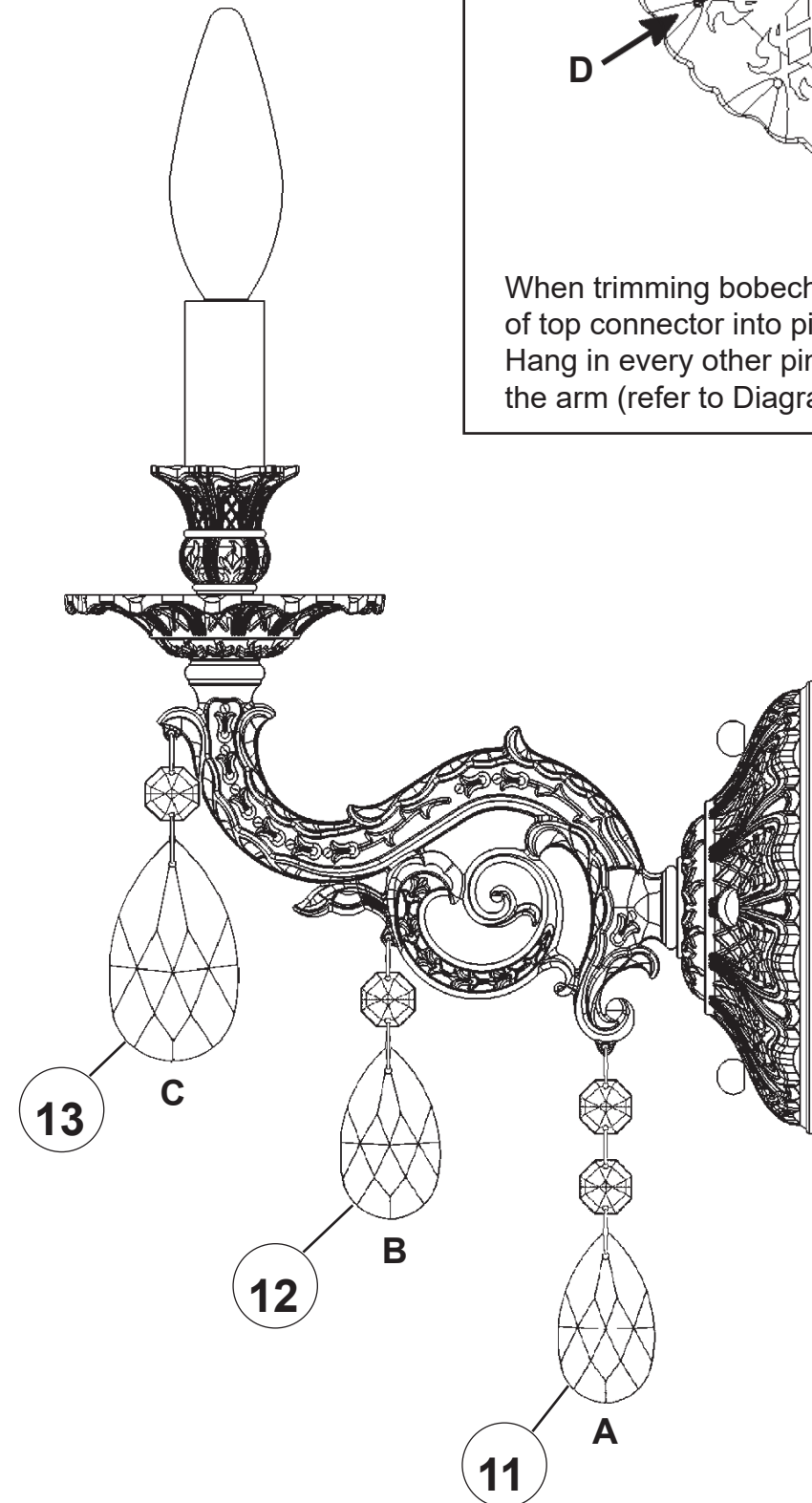
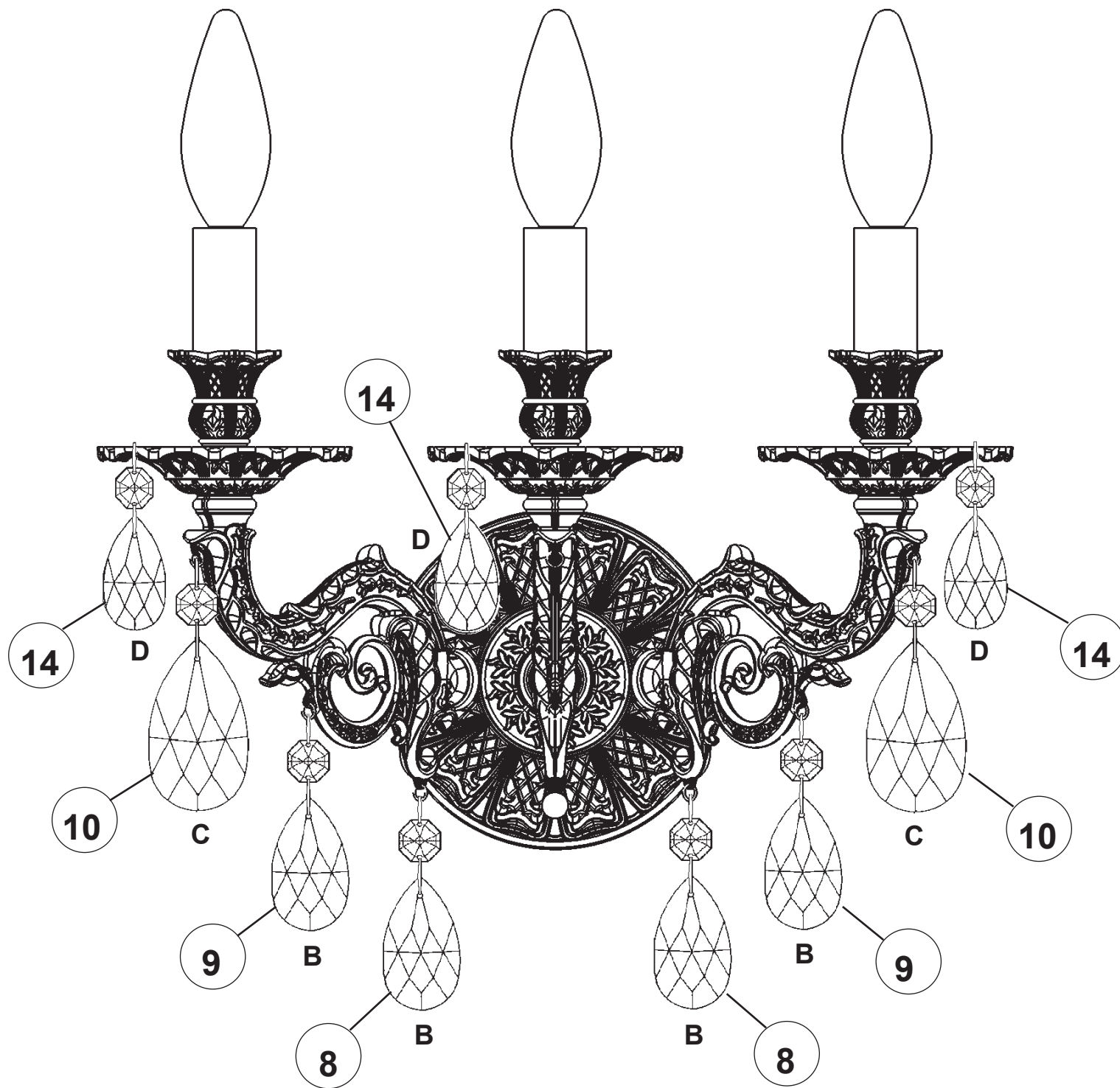



 **SCHONBEK** | 1870



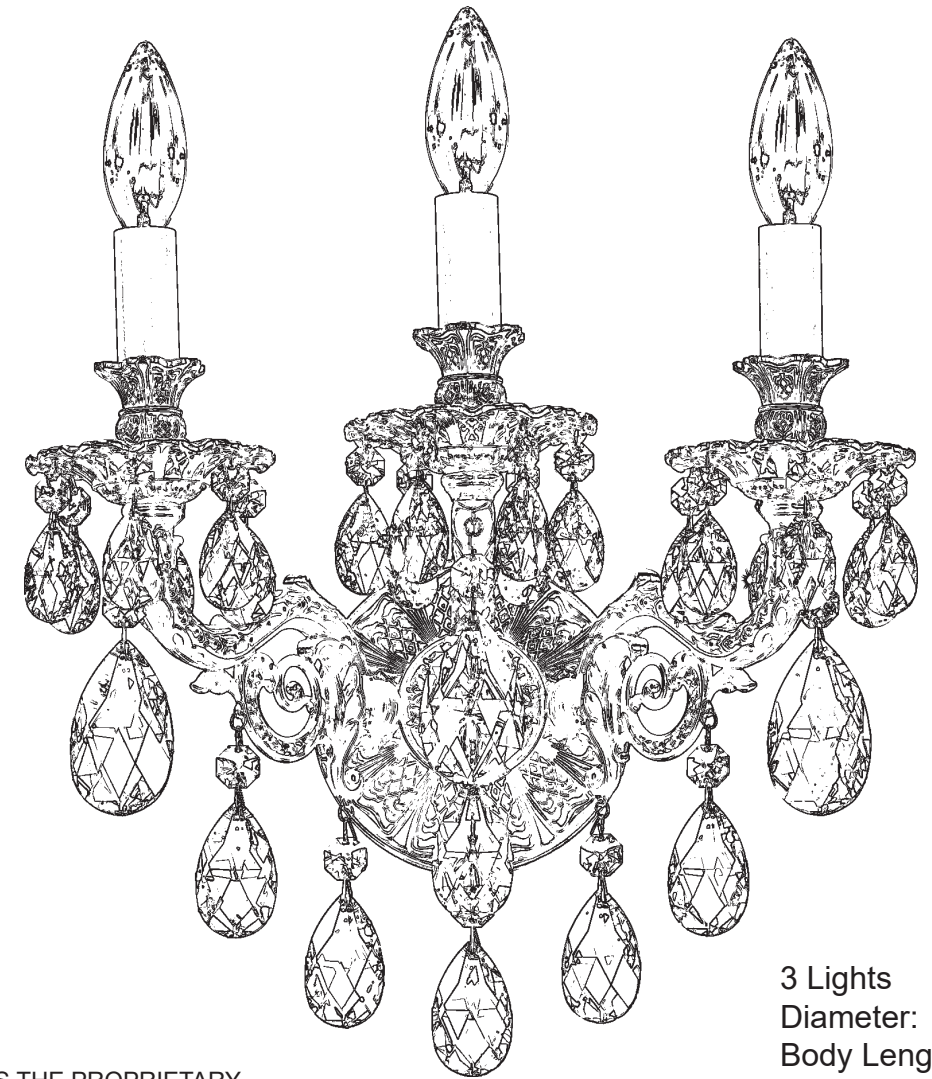







# MILANO 5643- \_\_\_\_\_



**T**HIS DESIGN IS THE PROPRIETARY TRADE DRESS/TRADEMARK OF W SCHONBEK LLC.

3 Lights  
Diameter: 13"  
Body Length: 15"  
Extension: 8-1/2"  
Hanging Weight: 3 lbs.

 **SCHONBEK** | 1870

								
MAX <b>60</b> W	110-120 V							

All electrical components must be installed by a licensed electrician in accordance with the National Electric Code and the appropriate local electrical codes.

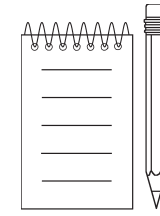
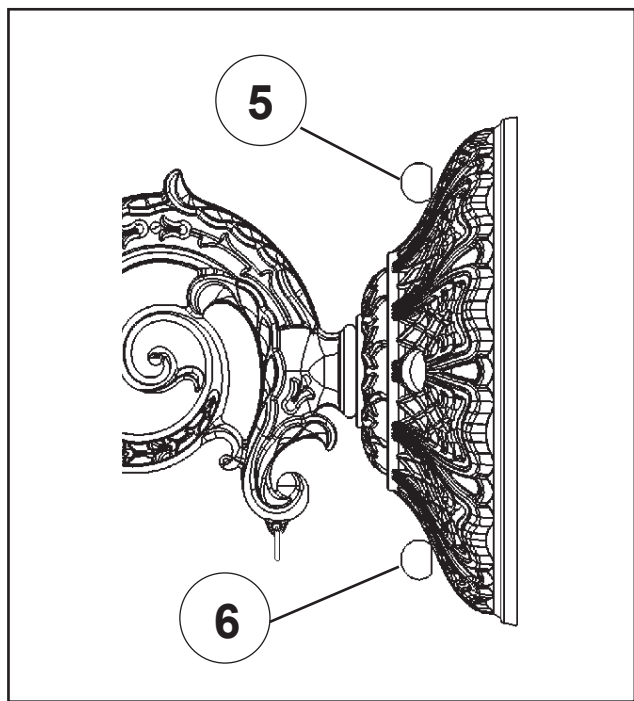
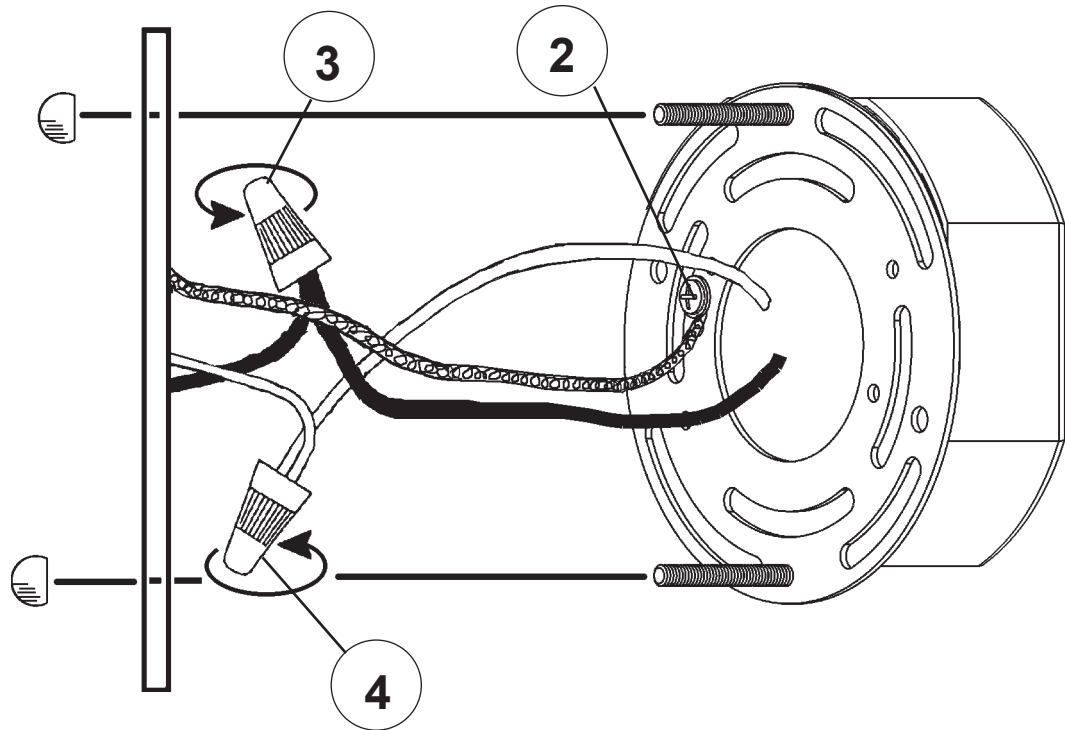
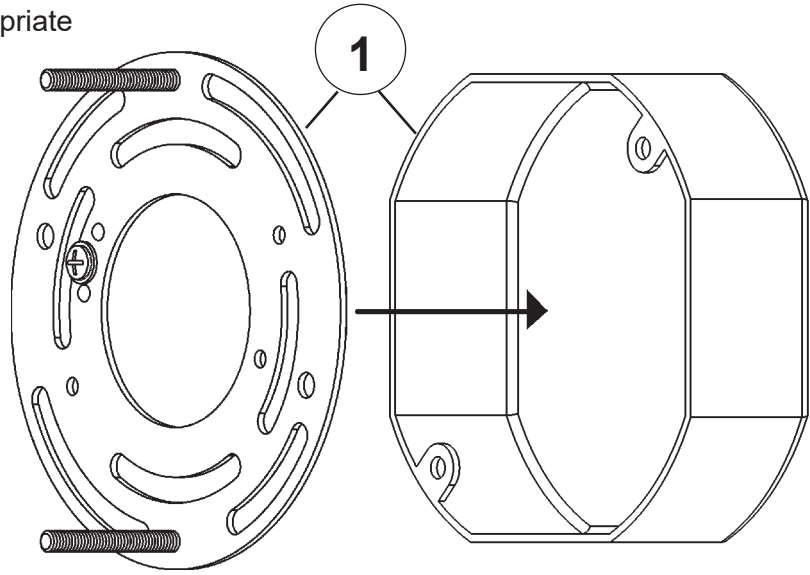

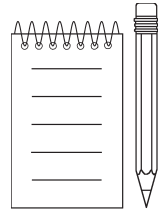

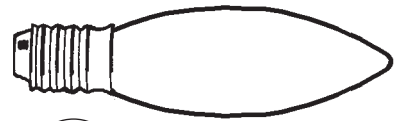

7

You will need 3 - B10  
25 Watts Recommended  
60 Watts Max

Install bulb and be sure  
to test fixture BEFORE  
trimming.

### DIAGRAM #1

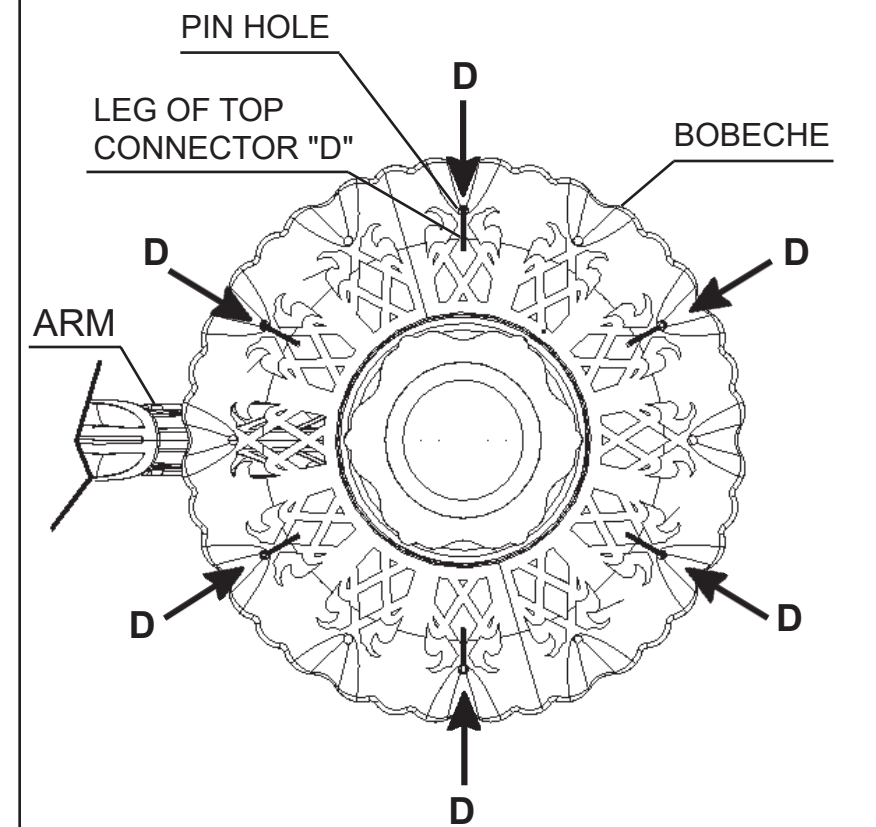

When trimming bobecche with letter "D", insert leg of top connector into pin hole from under bobecche. Hang in every other pin hole starting on either side of the arm (refer to Diagram #1)

