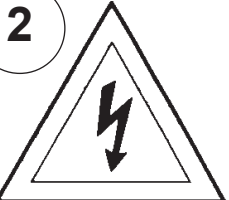
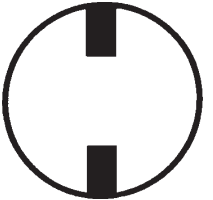

Instructions for electrician
STEPS 2 - 18

WARNING:

2  

Electrical Danger Turn Power Off

All electrical components must be installed by a licensed electrician in accordance with the National Electric Code and the appropriate local electrical codes.

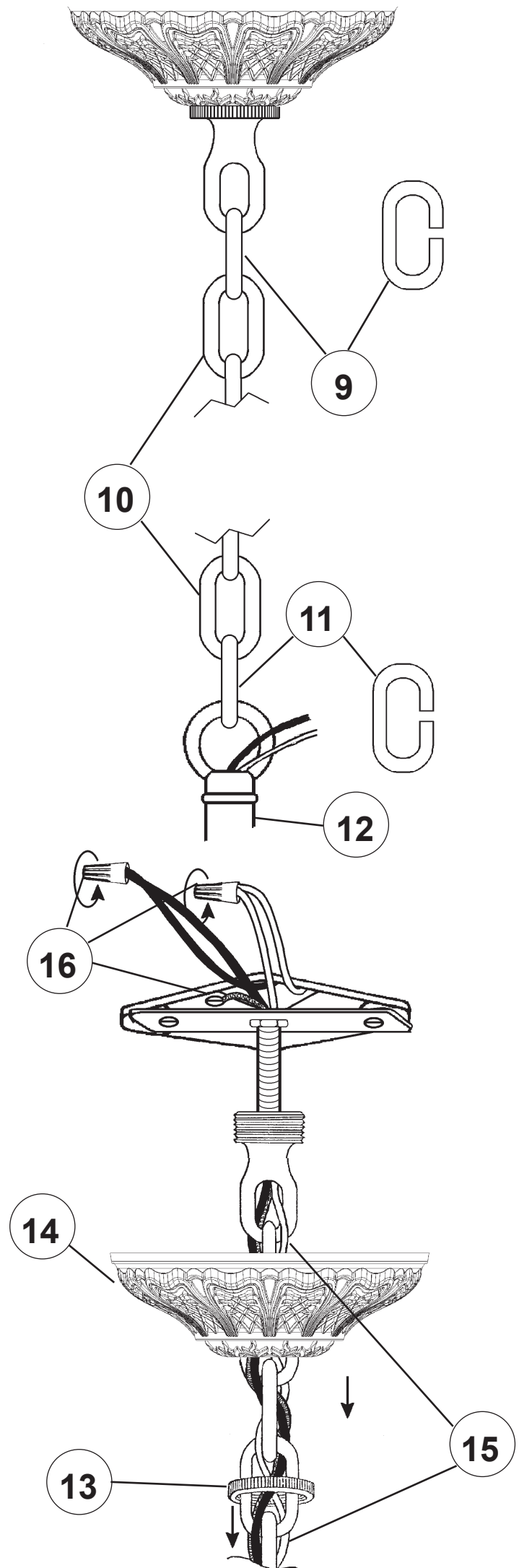
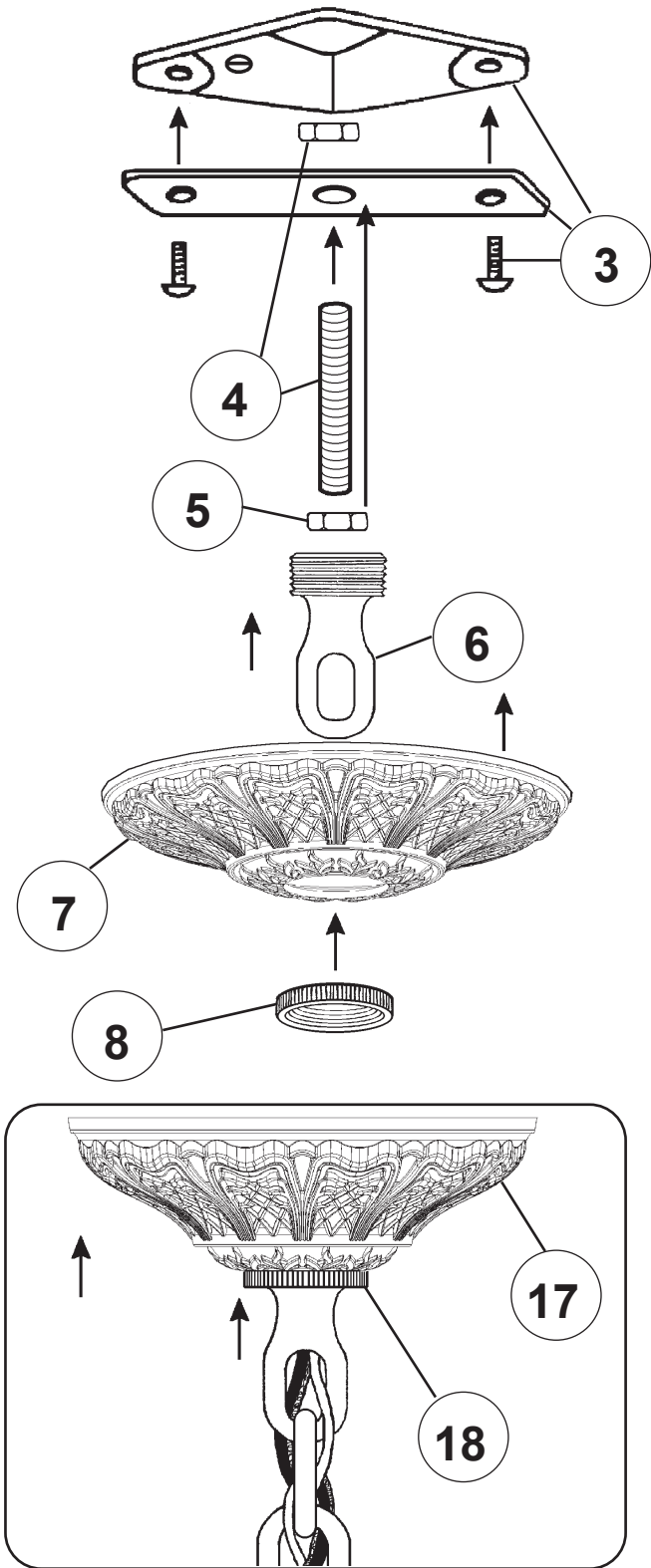

CHANDELIER 5677-____H TRIM DIAGRAM

(Finish Option)

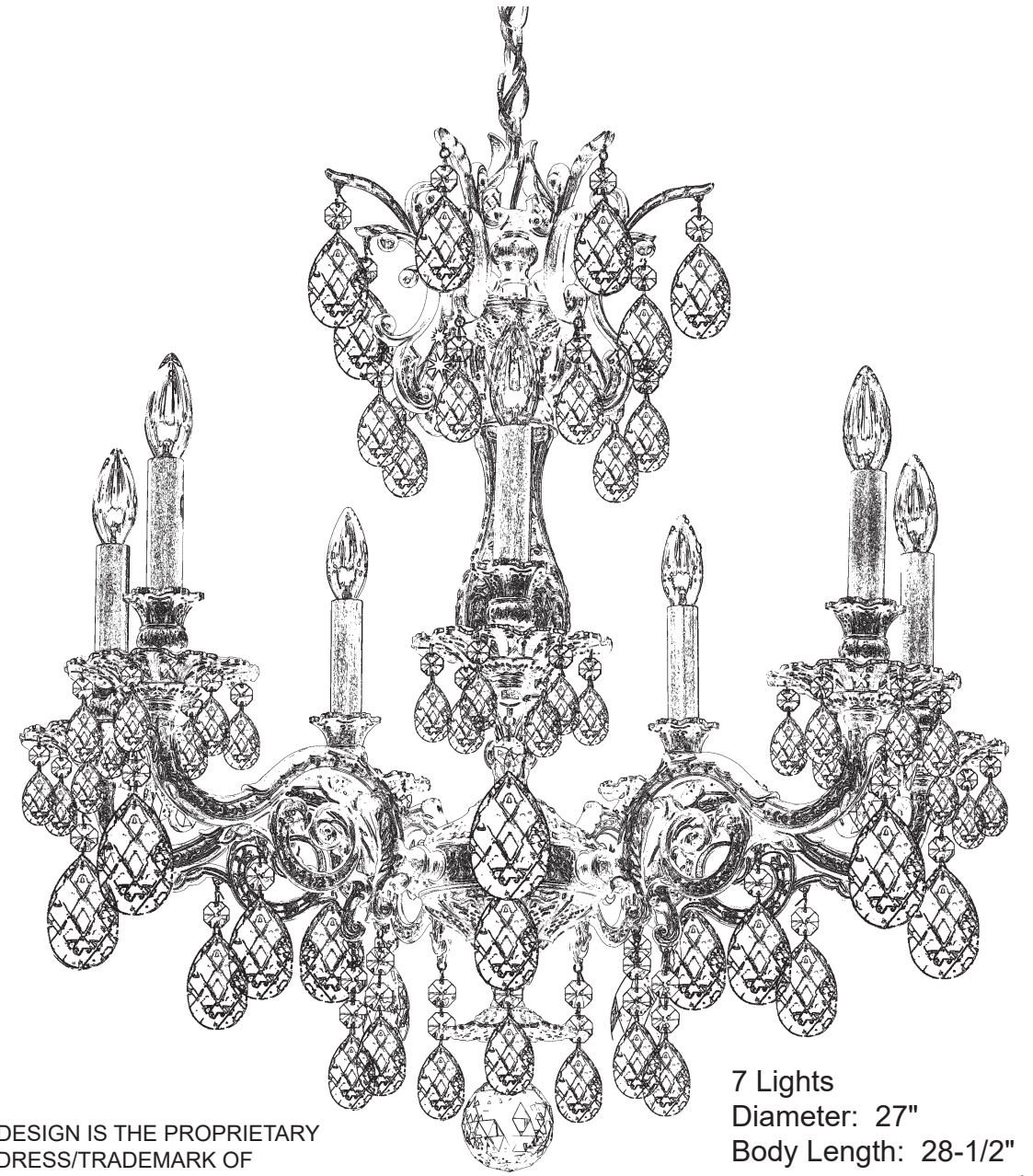

7 Lights
Diameter: 27"
Body Length: 28-1/2"
Hanging Weight: 19-1/2 lbs.

THIS DESIGN IS THE PROPRIETARY TRADE DRESS/TRADEMARK OF W SCHONBEK LLC.



See diagram on back page
Follow steps in exact order
Save this trim diagram for future reference

1 **IMPORTANT**
Person who opens carton should record the following information for future service.

CODE #	_____	Four-digit number on outside of carton.
PACKER #	_____	See crystal package label.
ORDER #	_____	See crystal package label.



Instructions for crystal trimming

STEPS 19 - 28

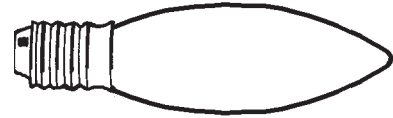

You will need 7 - B10
25 Watts Recommended
60 Watts Max

19

Install bulbs and be sure
to test fixture **BEFORE**
trimming.

DIAGRAM #1

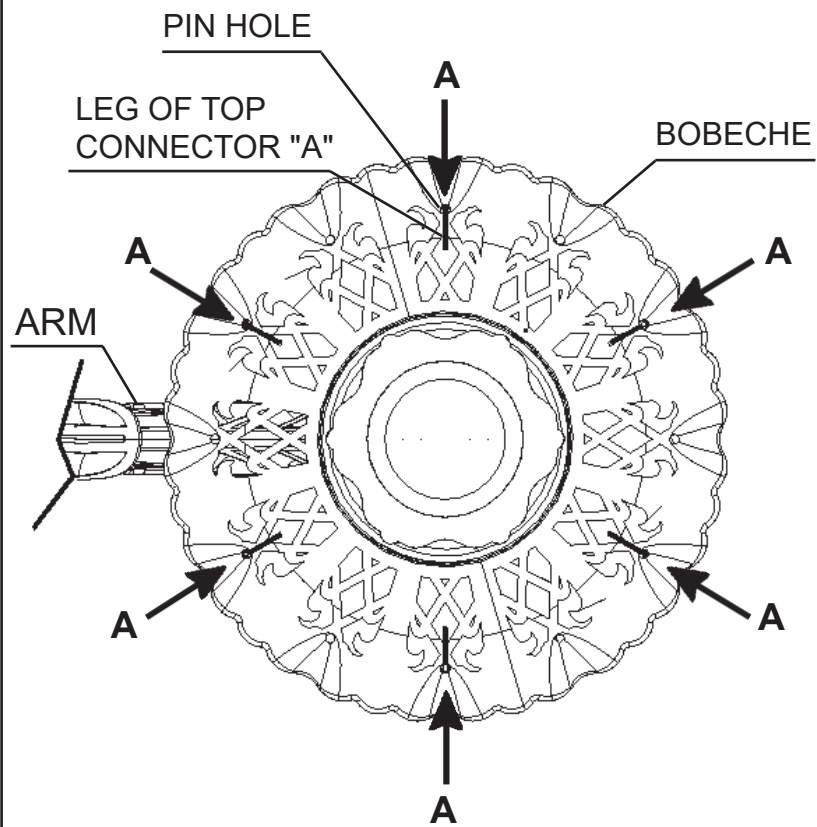

When trimming bobèche with letter "A", insert leg of top connector into pin hole from under bobèche. Hang in every other pin hole starting on either side of the arm (refer to Diagram #1)

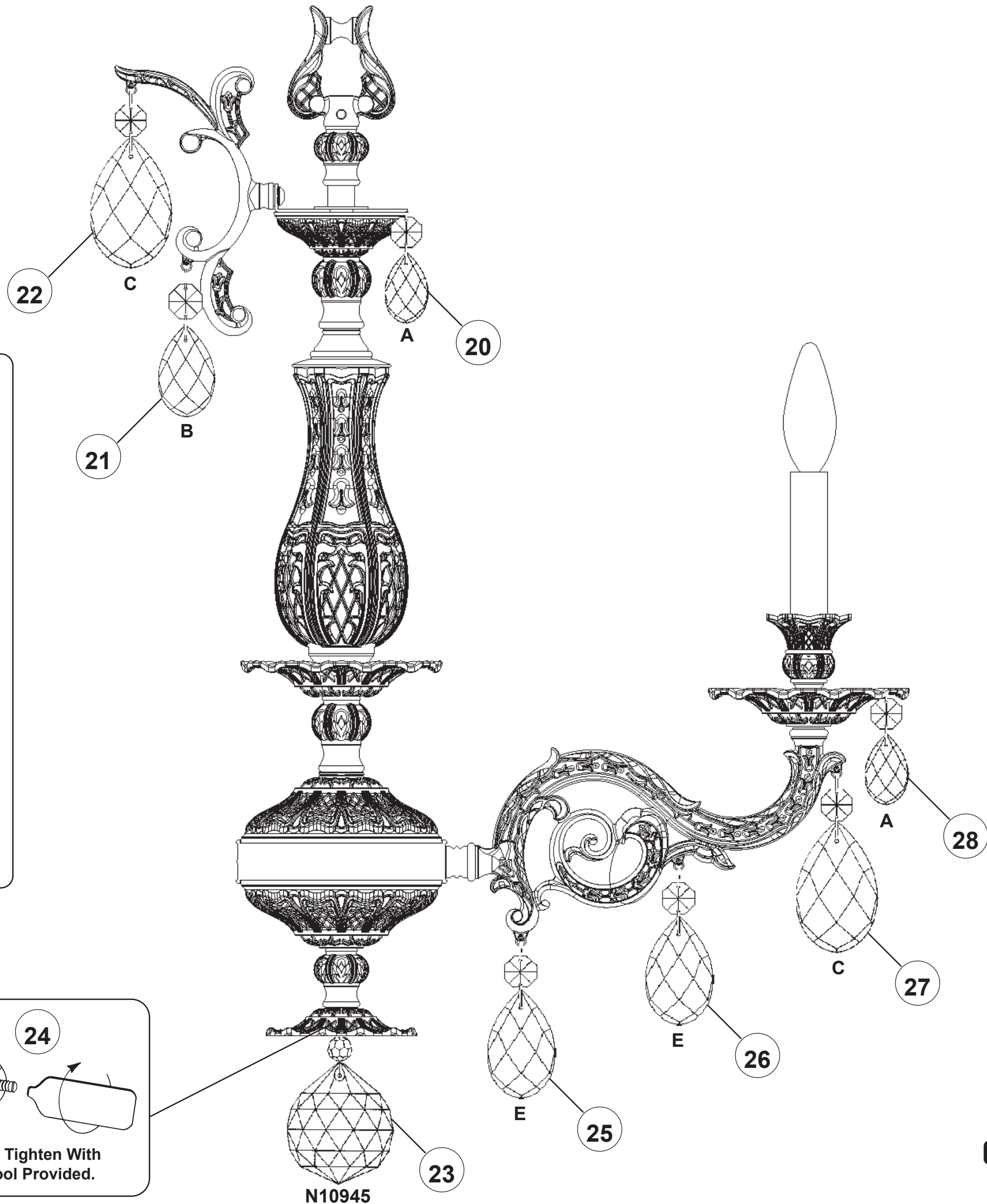

24

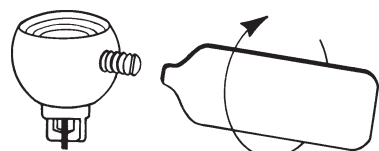

Tighten With
Tool Provided.

23

N10945

Instructions for electrician
STEPS 2 - 18

WARNING:

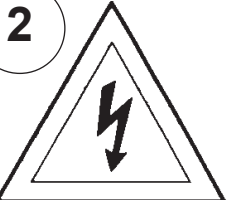
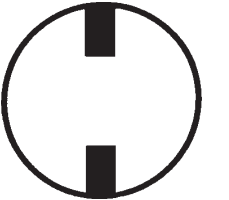
2  

Electrical Danger Turn Power Off

All electrical components must be installed by a licensed electrician in accordance with the National Electric Code and the appropriate local electrical codes.

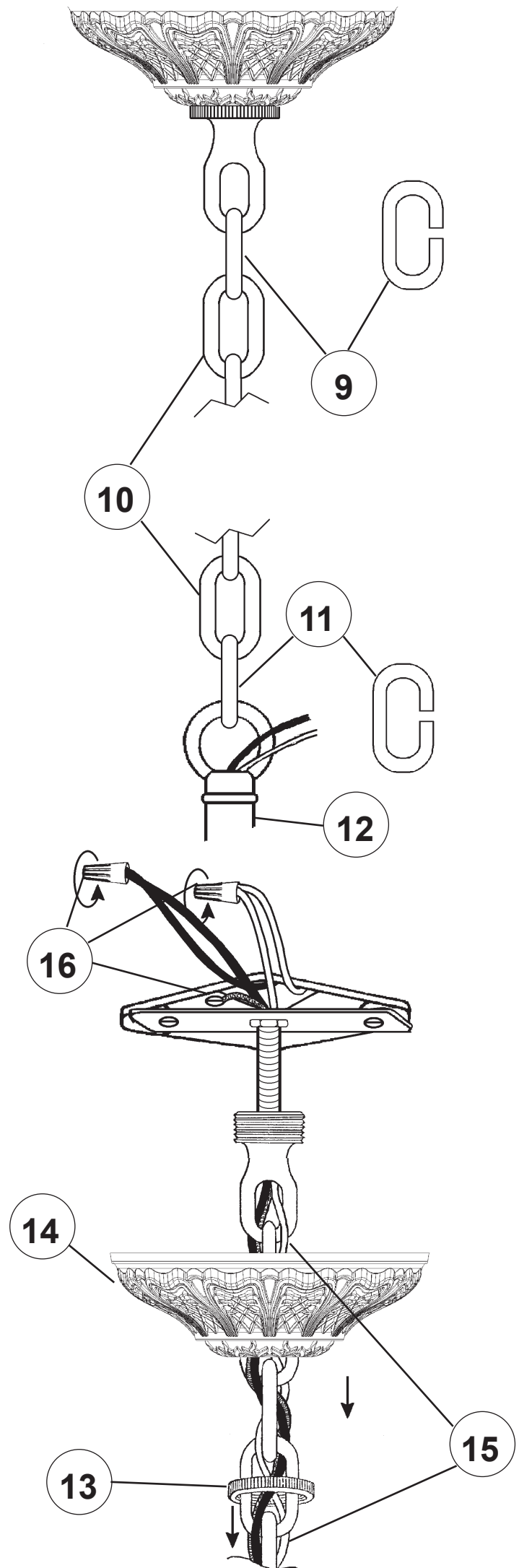
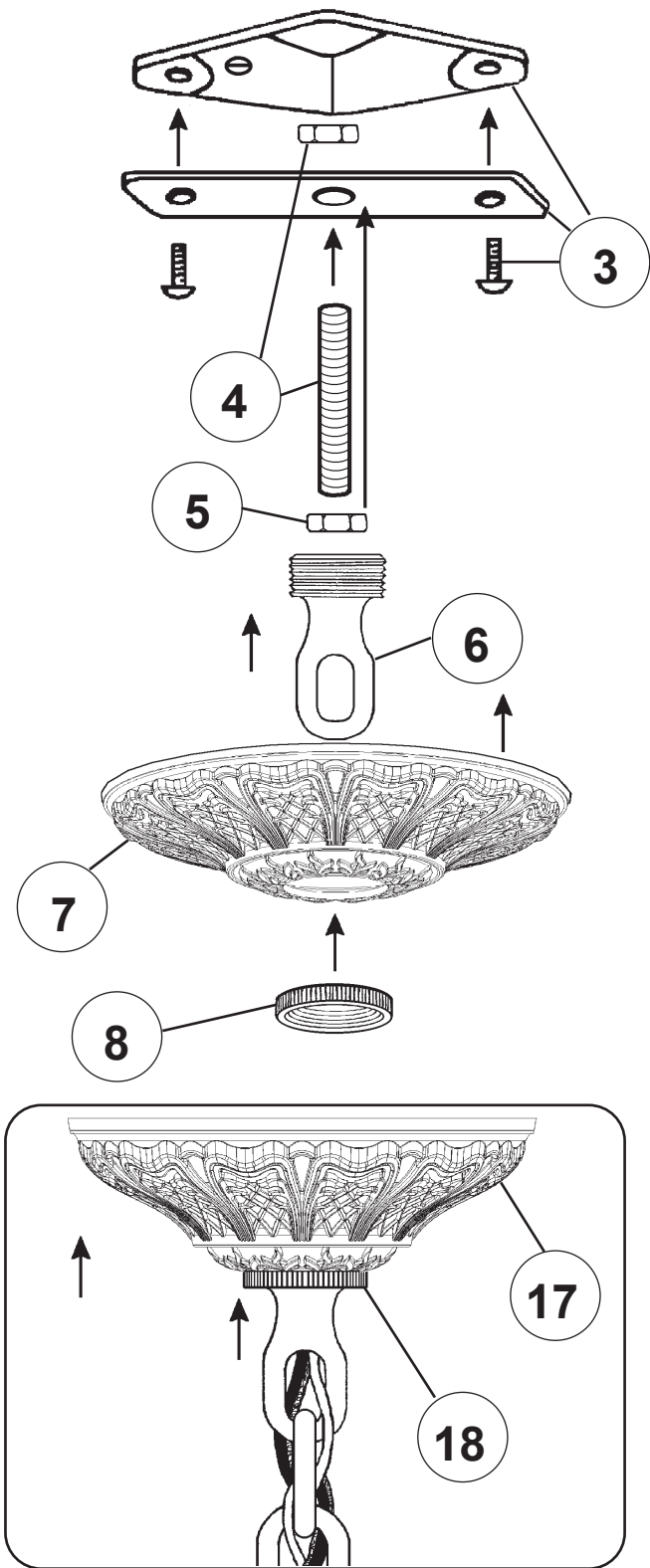

CHANDELIER 5677- _____ R TRIM DIAGRAM

(Finish Option)



7 Lights
Diameter: 27"
Body Length: 28-1/2"
Hanging Weight: 19-1/2 lbs.

THIS DESIGN IS THE PROPRIETARY TRADE DRESS/TRADEMARK OF W SCHONBEK LLC.



See diagram on back page
Follow steps in exact order
Save this trim diagram for future reference

1 **IMPORTANT**
Person who opens carton should record the following information for future service.

CODE # _____ Four-digit number on outside of carton.
PACKER # _____ See crystal package label.
ORDER # _____ See crystal package label.



Instructions for crystal trimming

STEPS 19 - 28

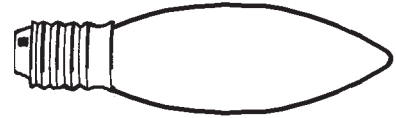

You will need 7 - B10
25 Watts Recommended
60 Watts Max

19

Install bulbs and be sure
to test fixture **BEFORE**
trimming.

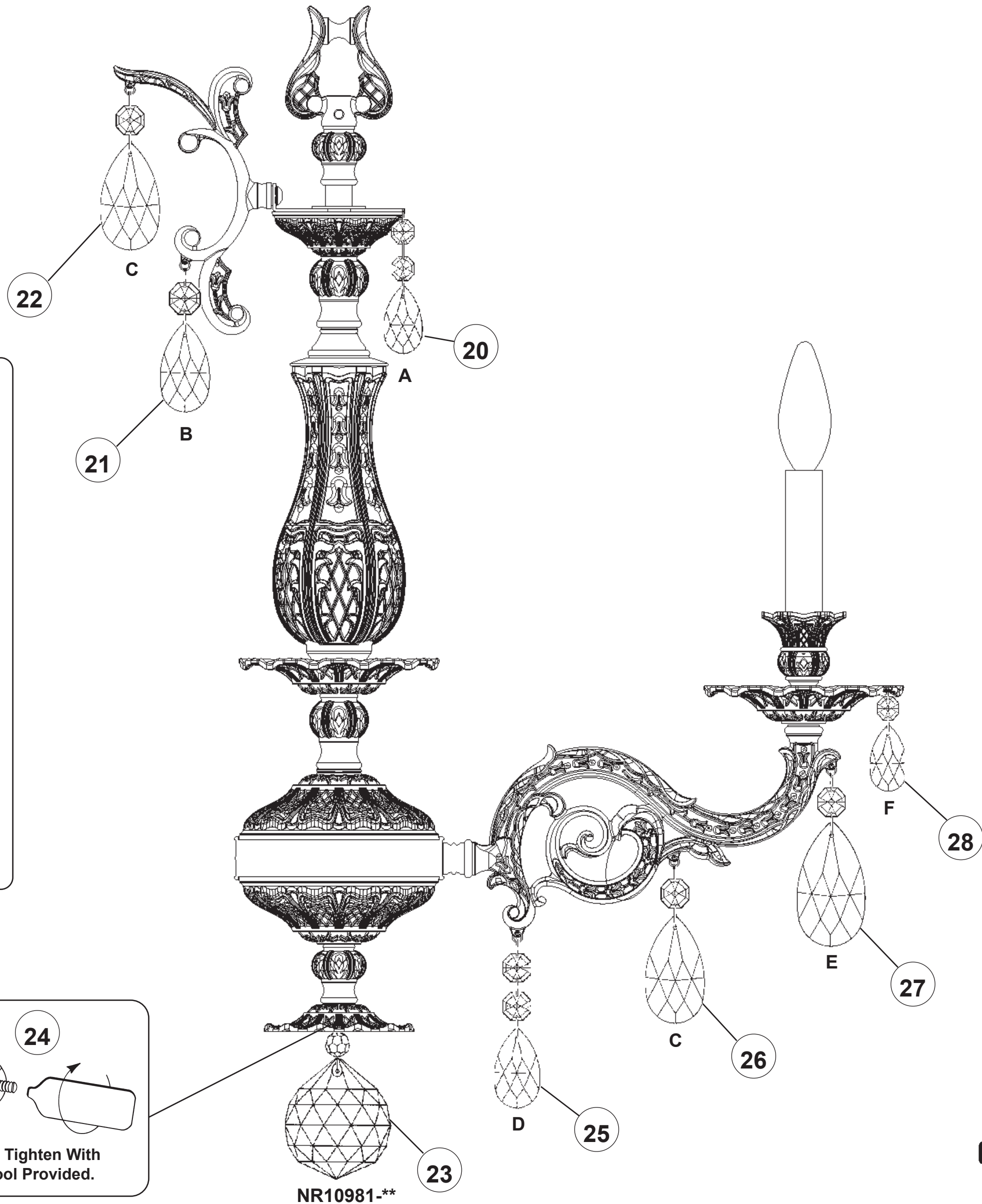
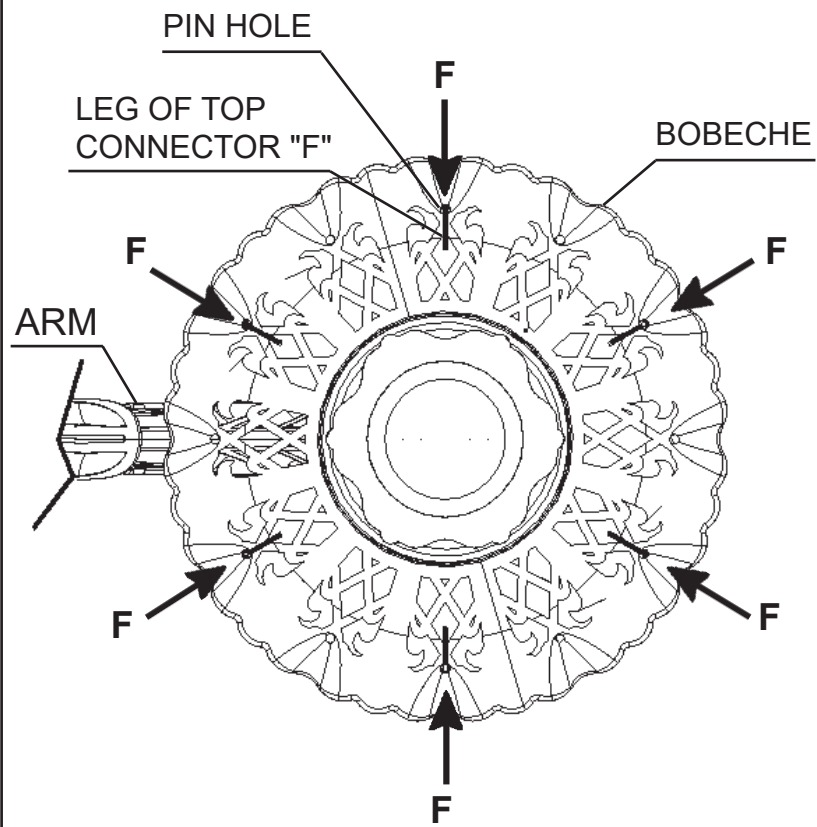
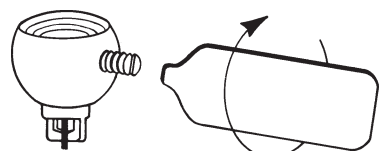

DIAGRAM #1



When trimming bobèche with letter "F", insert leg of top connector into pin hole from under bobèche. Hang in every other pin hole starting on either side of the arm (refer to Diagram #1)

24



Tighten With
Tool Provided.

23

NR10981-**

Instructions for electrician
STEPS 2 - 18

WARNING:

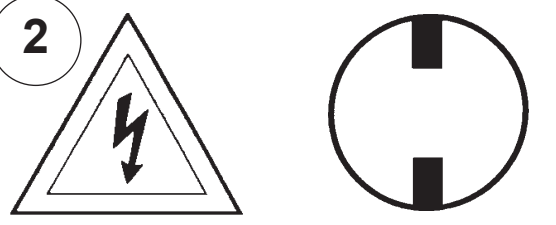
2  **Electrical Danger Turn Power Off**

All electrical components must be installed by a licensed electrician in accordance with the National Electric Code and the appropriate local electrical codes.

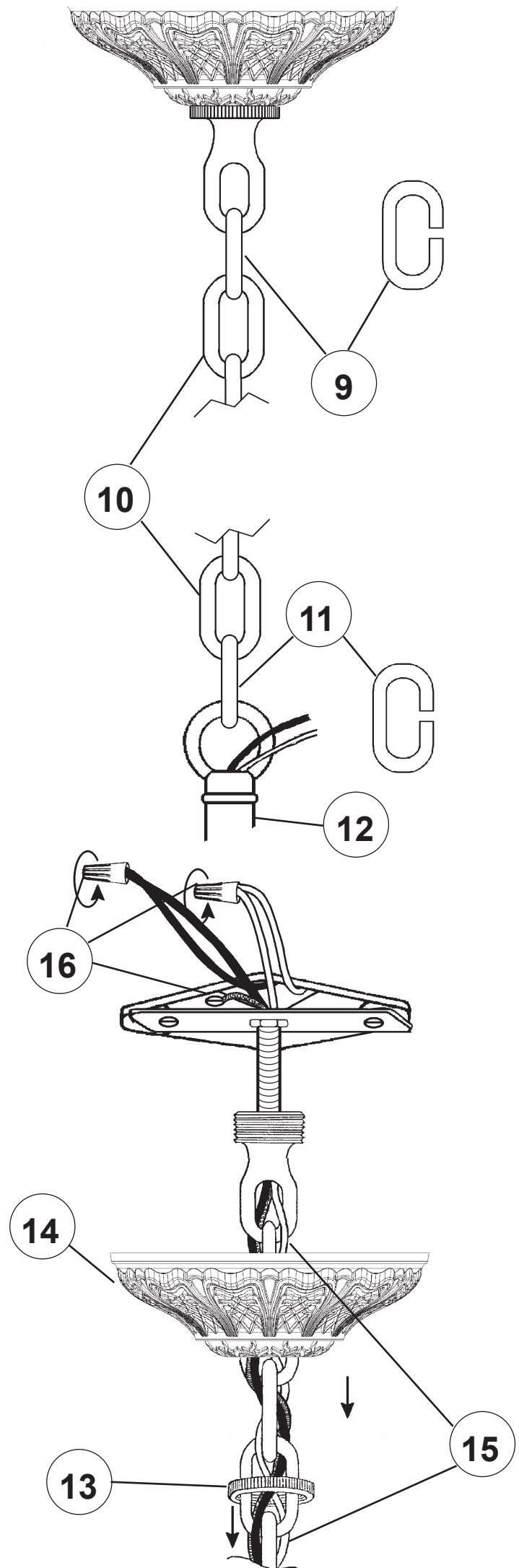
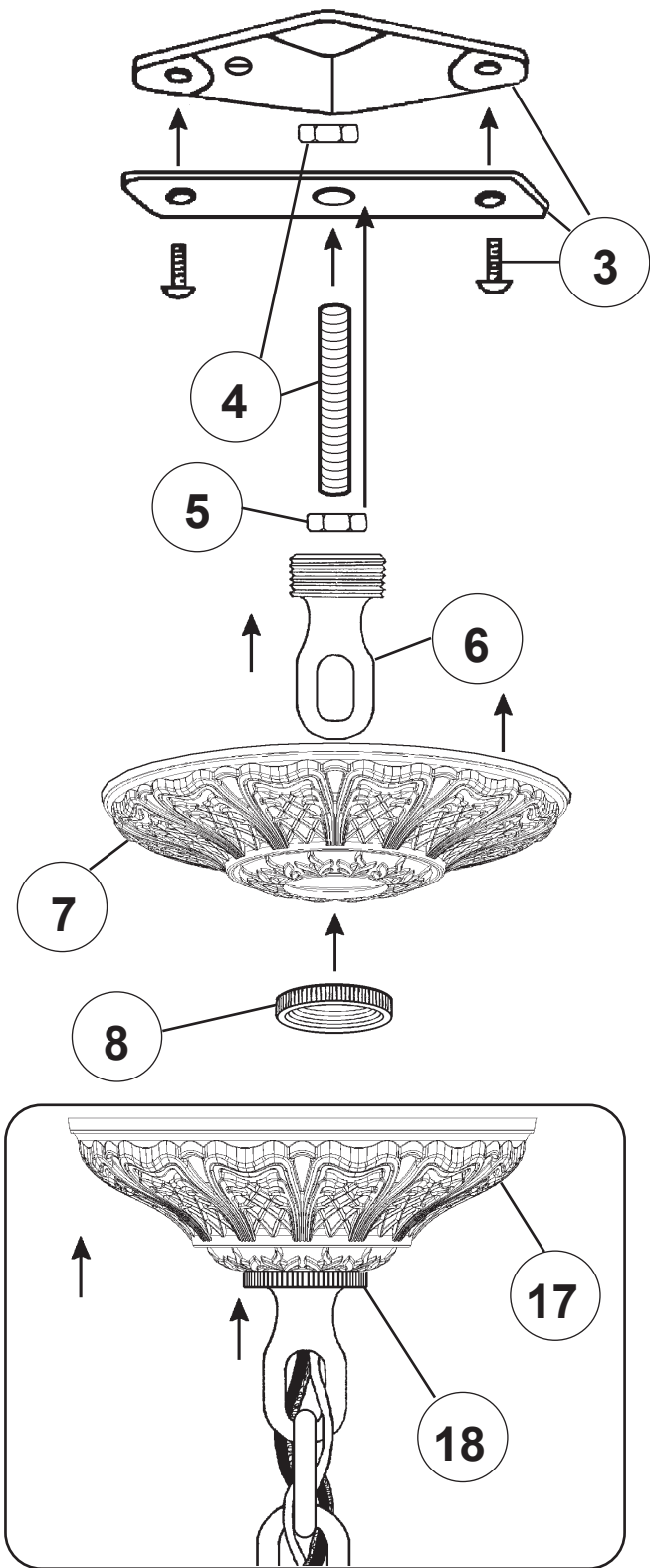

CHANDELIER 5677- _____ TRIM DIAGRAM

(Finish Option) (Trim Option)

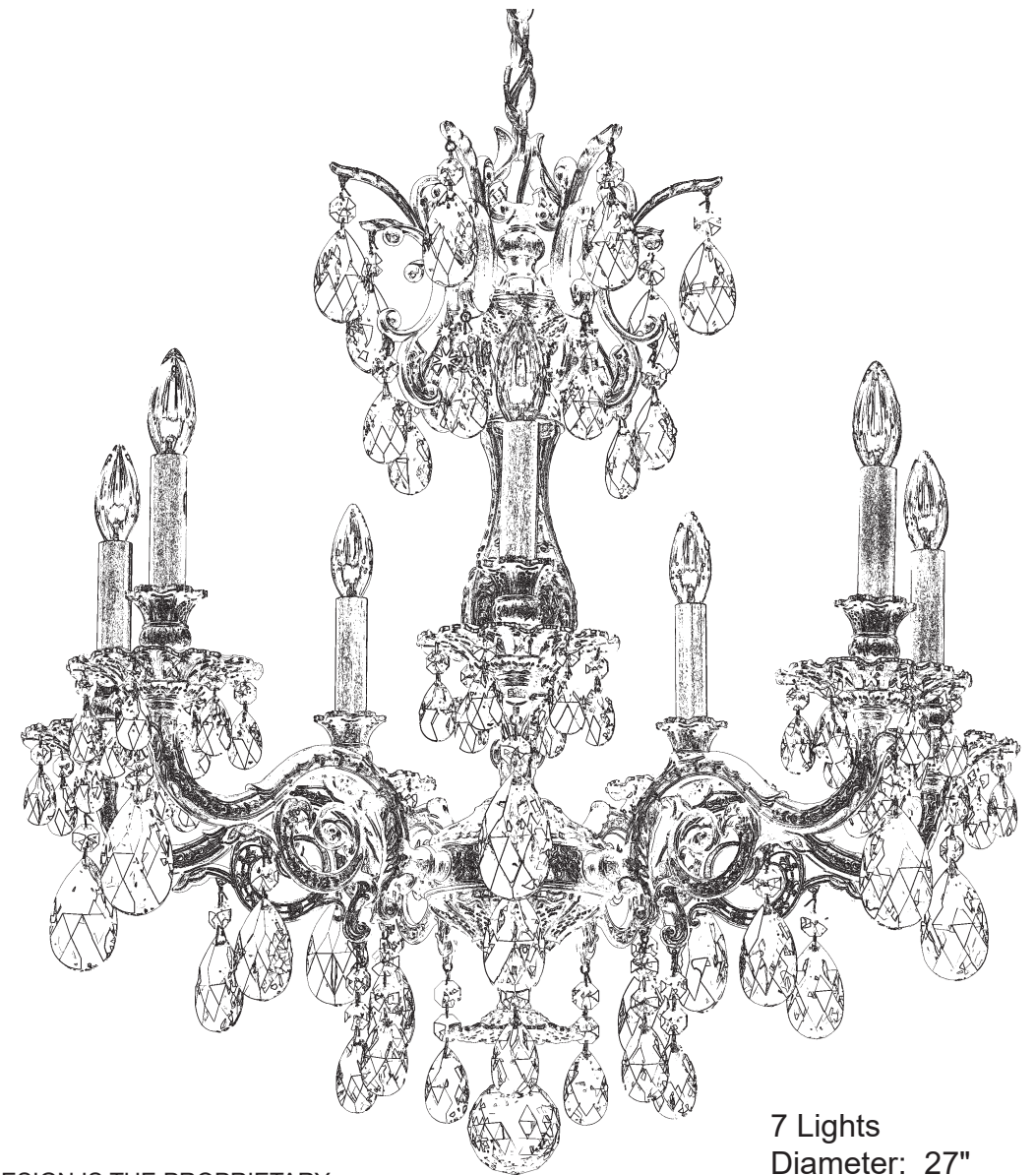

7 Lights
Diameter: 27"
Body Length: 28-1/2"
Hanging Weight: 19-1/2 lbs.

THIS DESIGN IS THE PROPRIETARY TRADE DRESS/TRADEMARK OF W SCHONBEK LLC.



See diagram on back page
Follow steps in exact order
Save this trim diagram for future reference

1 **IMPORTANT**
Person who opens carton should record the following information for future service.

CODE # _____ Four-digit number on outside of carton.
PACKER # _____ See crystal package label.
ORDER # _____ See crystal package label.



Instructions for crystal trimming

STEPS 19 - 28

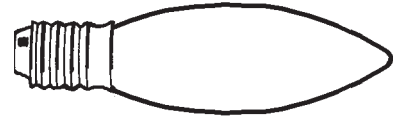

You will need 7 - B10
25 Watts Recommended
60 Watts Max

19

Install bulbs and be sure
to test fixture **BEFORE**
trimming.

DIAGRAM #1

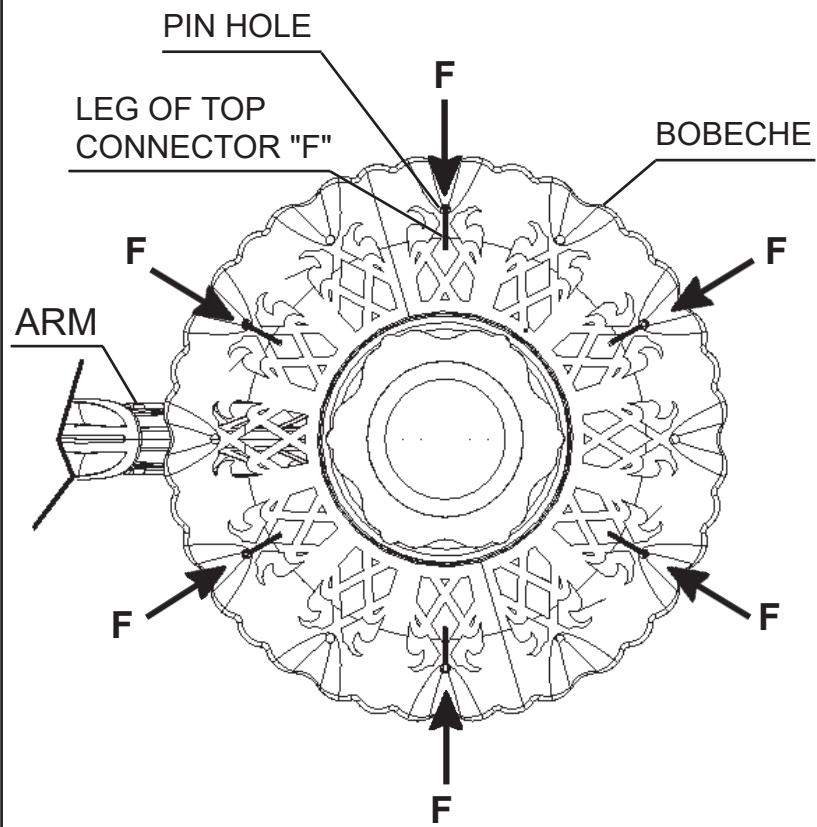

When trimming bobèche with letter "F", insert leg of top connector into pin hole from under bobèche. Hang in every other pin hole starting on either side of the arm (refer to Diagram #1)

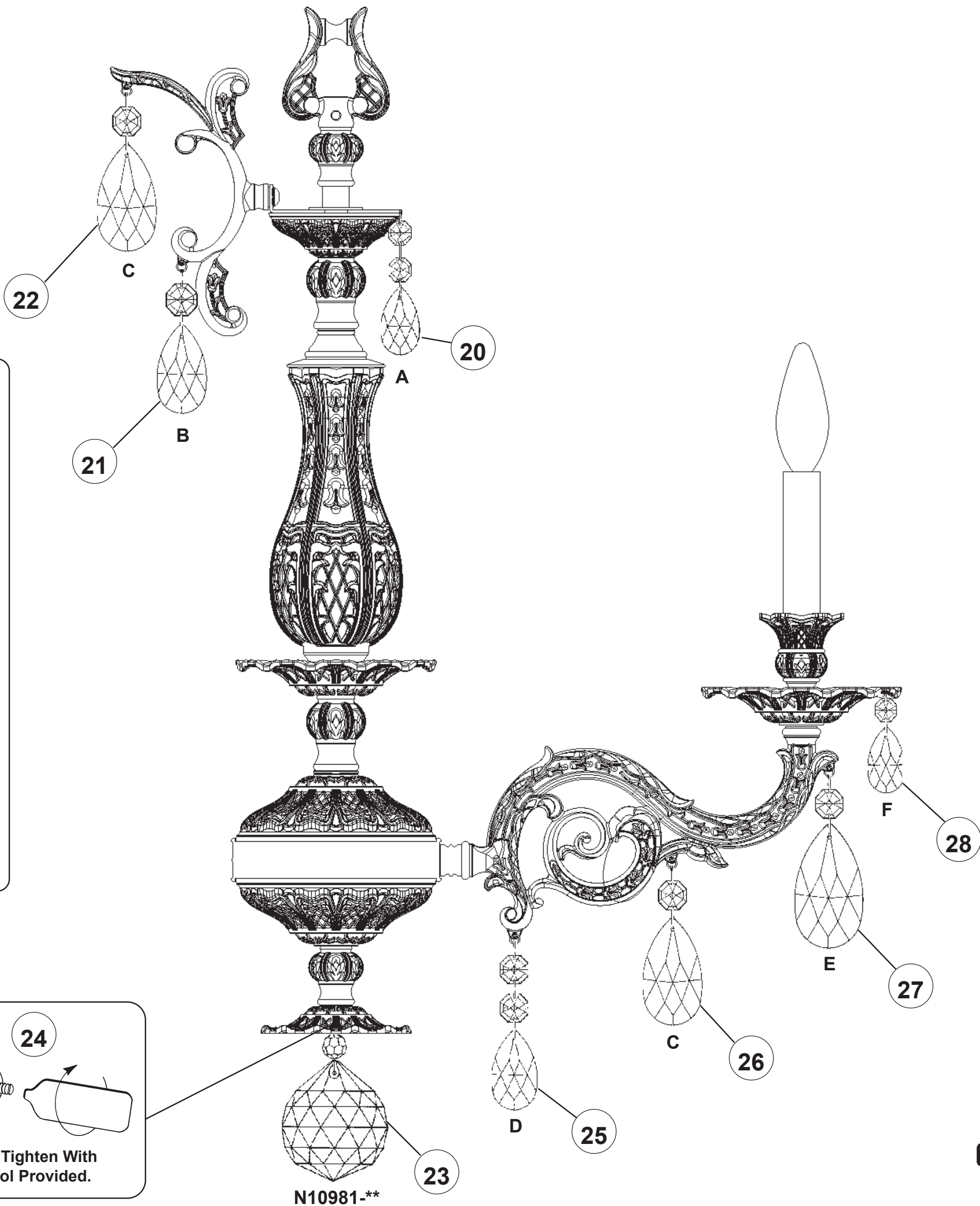

24

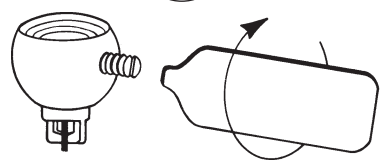

Tighten With
Tool Provided.

23

N10981-**

