

 **SCHONBEK** | 1870

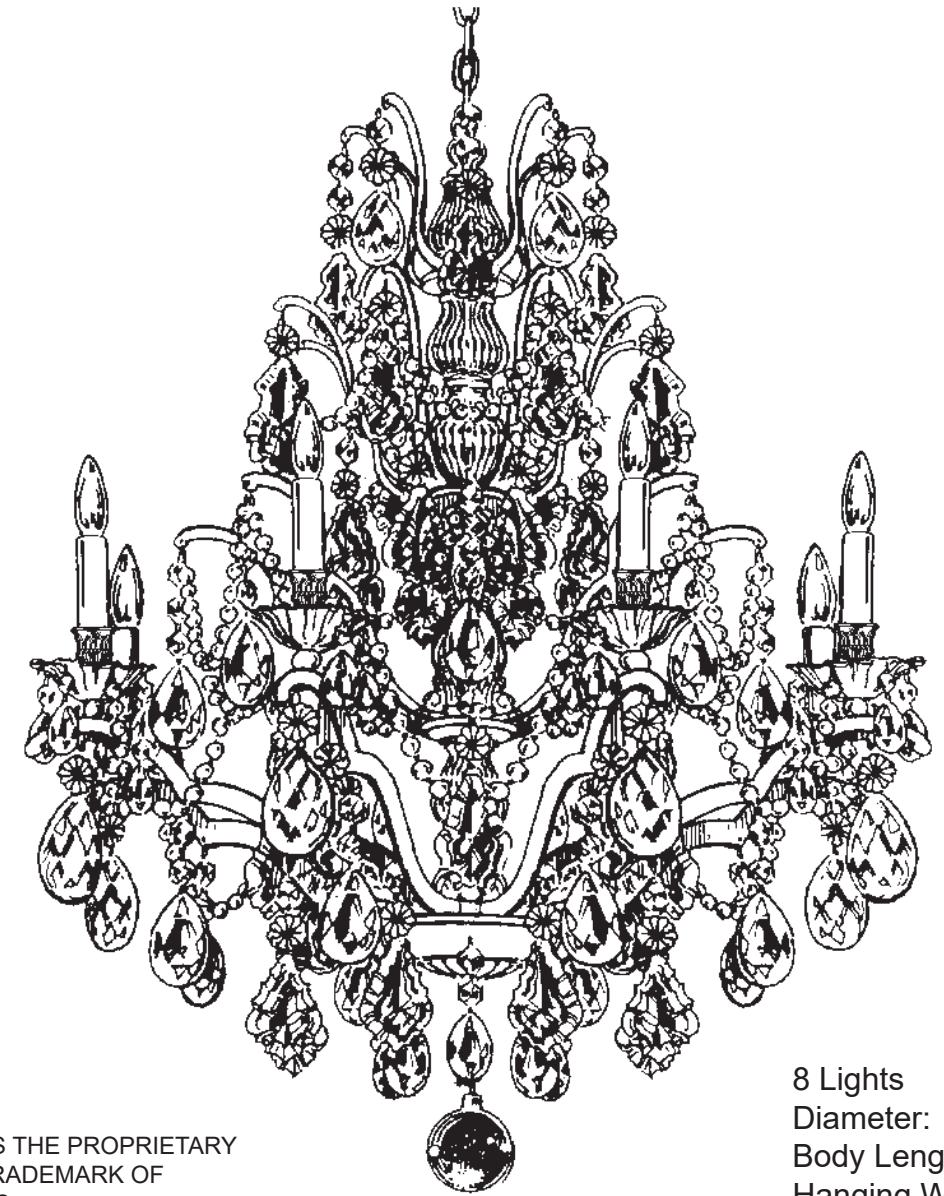









BORDEAUX 5771- ___ H



THIS DESIGN IS THE PROPRIETARY TRADE DRESS/TRADEMARK OF W SCHONBEK LLC.

8 Lights
Diameter: 28"
Body Length: 33"
Hanging Weight: 22 lbs.

 **SCHONBEK** | 1870

								
MAX 60 W		110-120 V						

All electrical components must be installed by a licensed electrician in accordance with the National Electric Code and the appropriate local electrical codes.

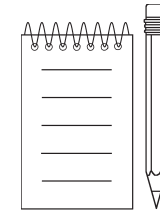
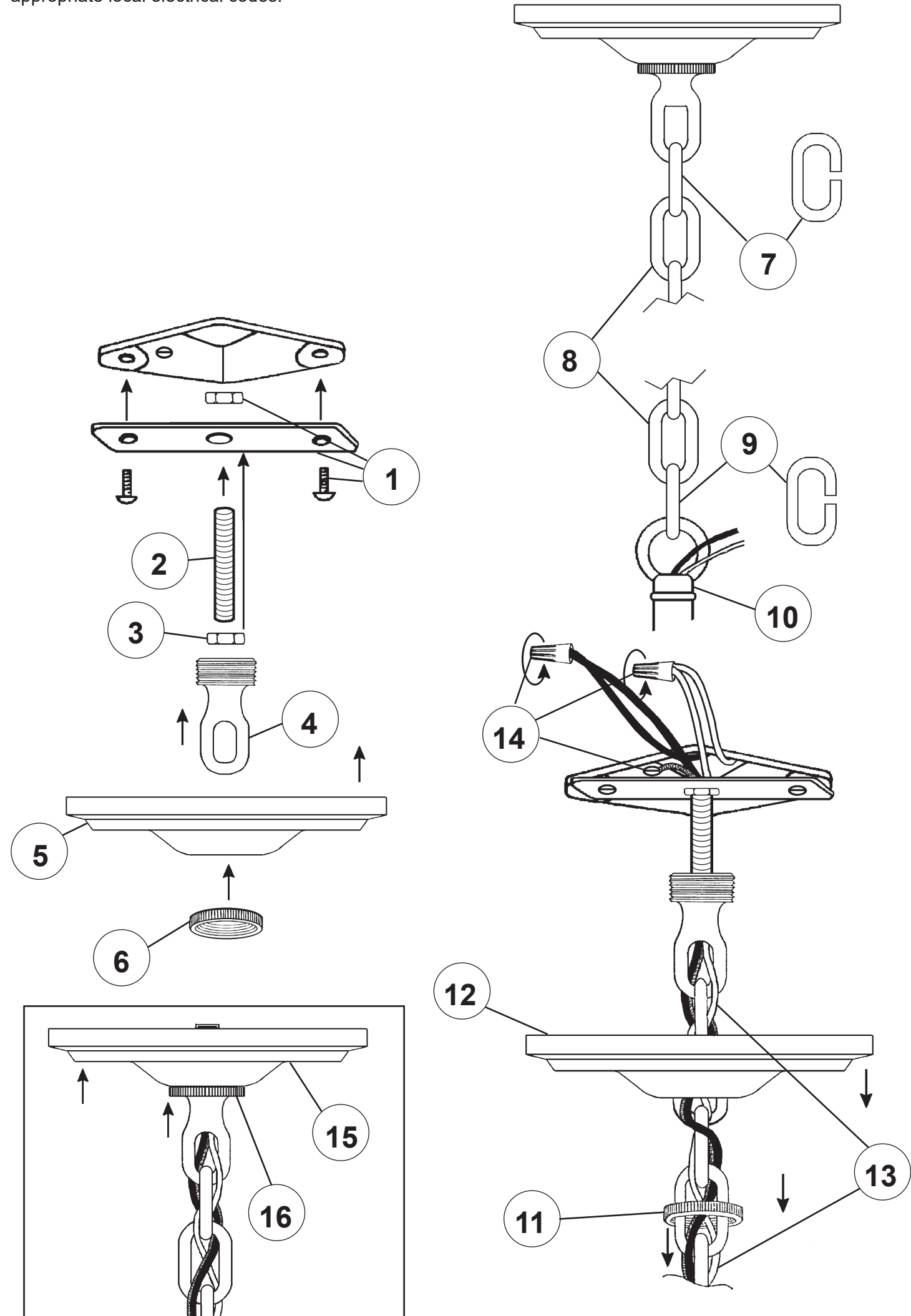



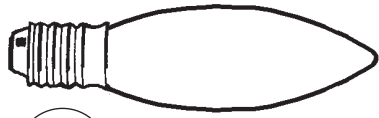

17

You will need 8 - B10
25 Watts Recommended
60 Watts Max

Install bulbs and be sure
to test fixture **BEFORE**
trimming.

