

TRILLIANE 5856- __ _ H

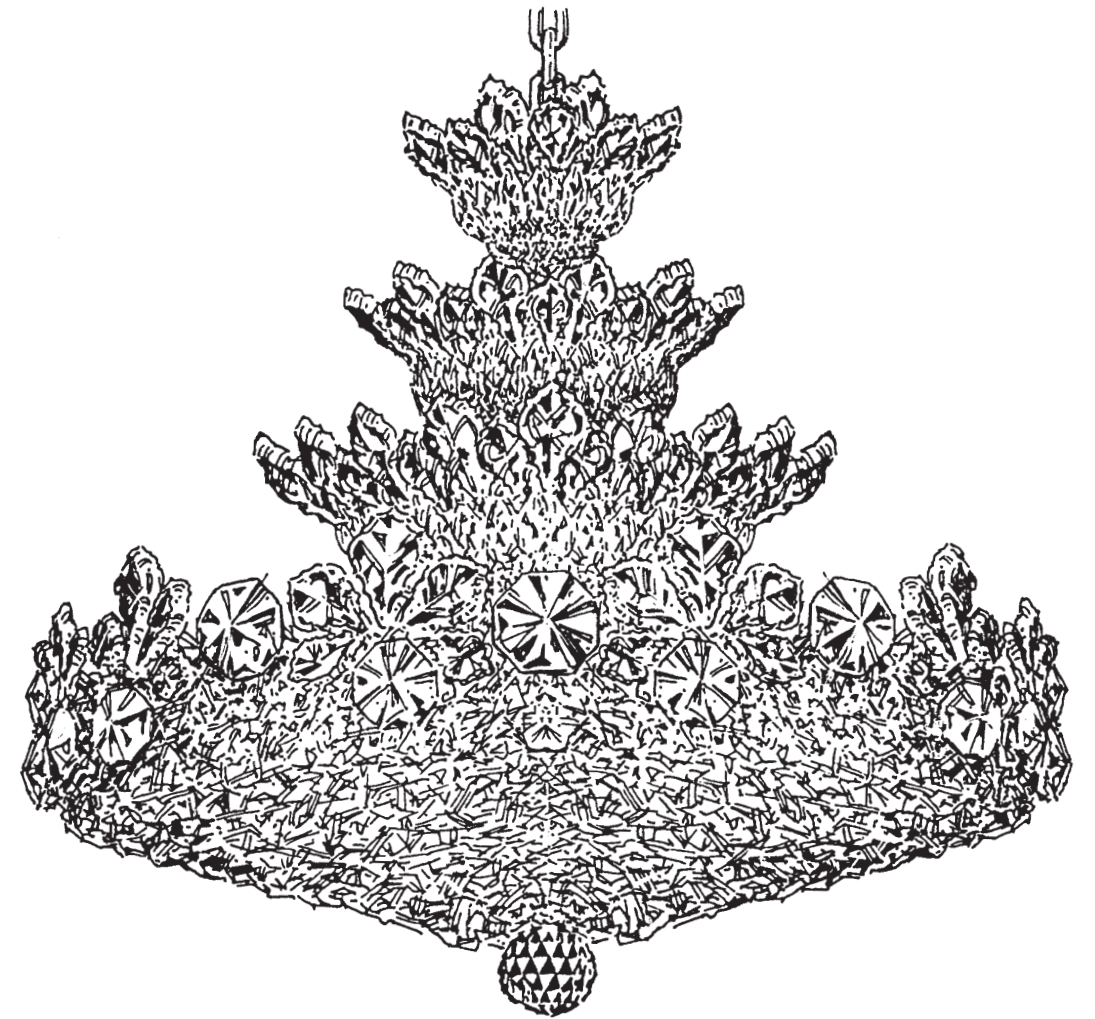











THIS DESIGN IS THE PROPRIETARY TRADE DRESS/TRADEMARK OF W SCHONBEK LLC.

30 Lights
Diameter: 30"
Body Length: 27"
Hanging Weight: 64 lbs.

 **SCHONBEK** | 1870

 **SCHONBEK** | 1870

								
MAX 40 W	110-120 V							

All electrical components must be installed by a licensed electrician in accordance with the National Electric Code and the appropriate local electrical codes.

WARNING: THIS LUMINAIRE MUST BE MOUNTED OR SUPPORTED INDEPENDENTLY OF AN OUTLET BOX.

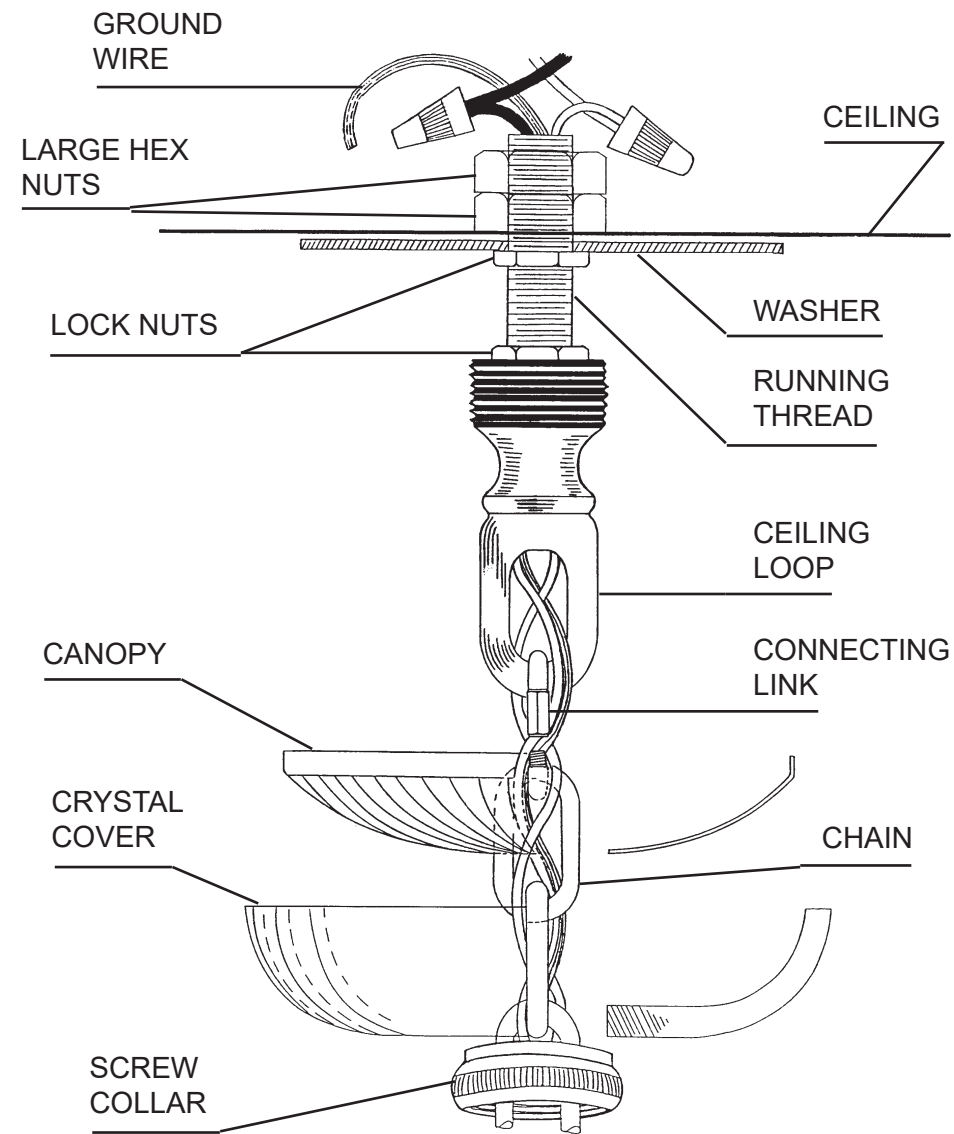

- 1 MAKE SURE POWER IS DISCONNECTED!!**
- 2** Attach washer to supporting member in ceiling sufficient to support weight of fixture.
- 3** Slip screw collar, crystal cover and metal canopy over chain. Determine the suspension length of the fixture and cut chain, if necessary. Use two connecting links to attach chain to chandelier loop and ceiling loop.
- 4** Insert stem wire through chain and ceiling loop. Connect wires. Fixture **MUST** be grounded.
- 5** Check distance from ceiling to loop to assure canopy assembly will be flush against ceiling.
- 6** Attach canopy to ceiling with screw collar.

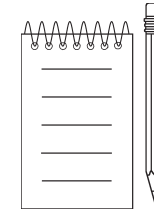

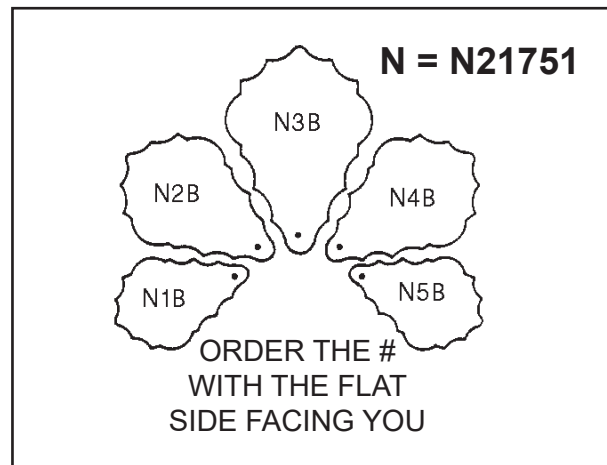
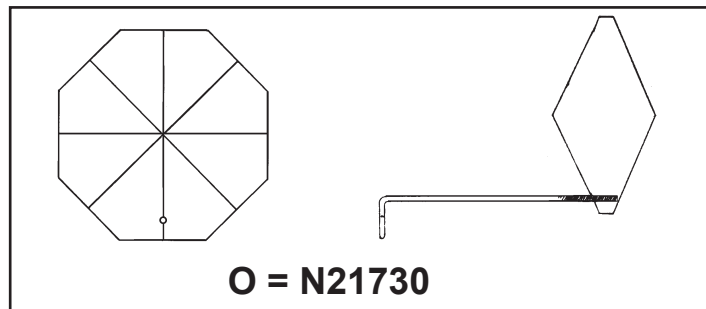
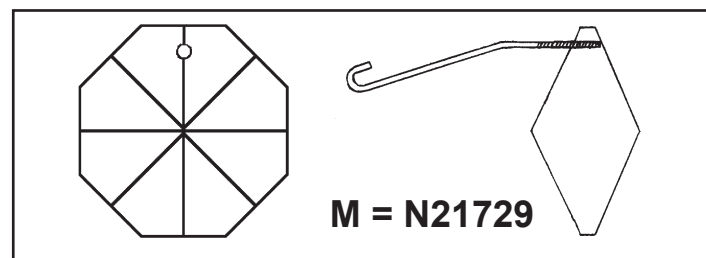
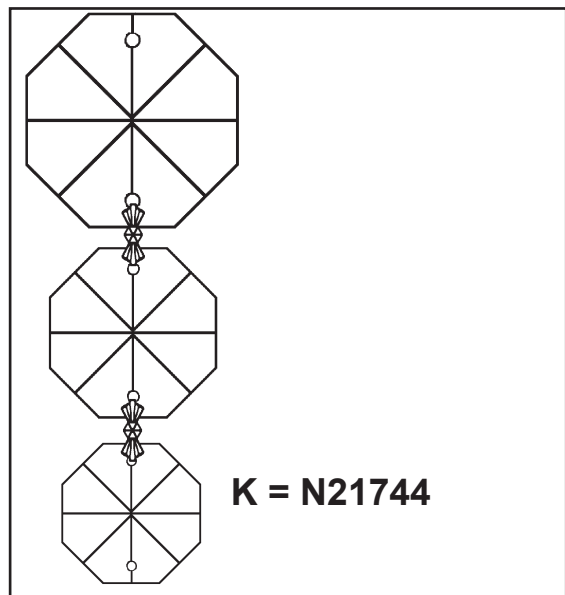
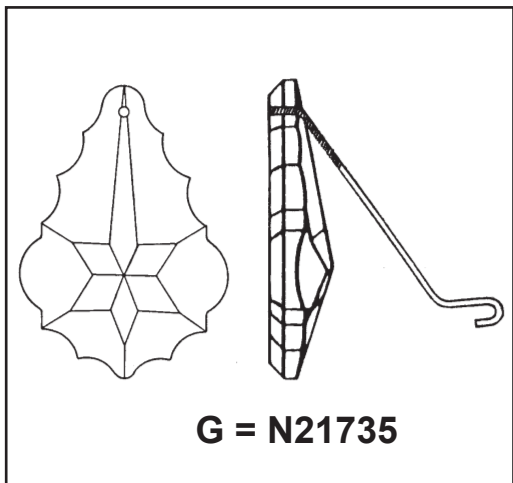
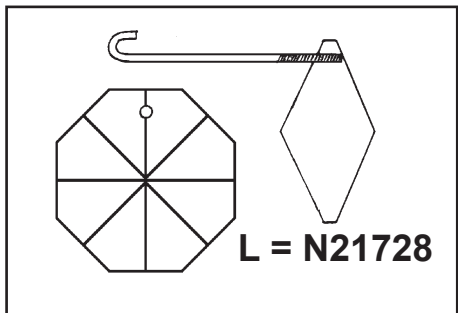
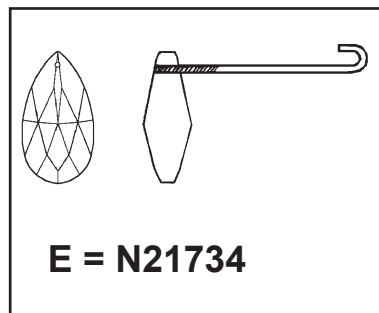
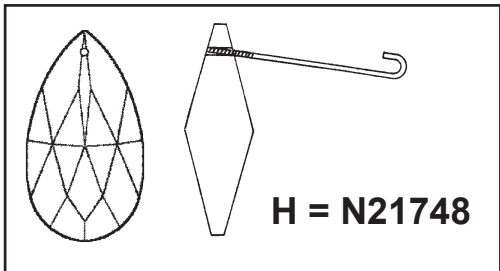
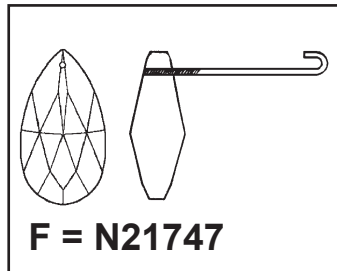
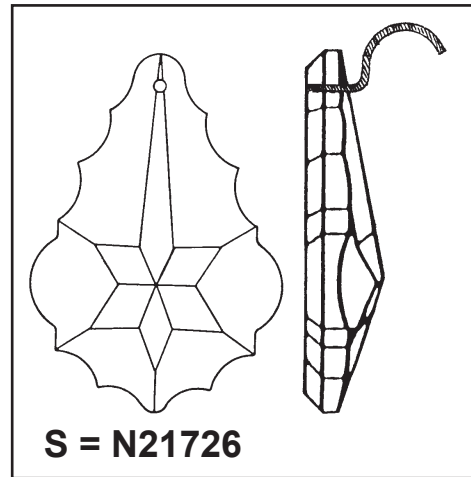
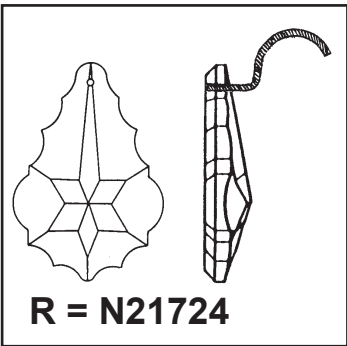
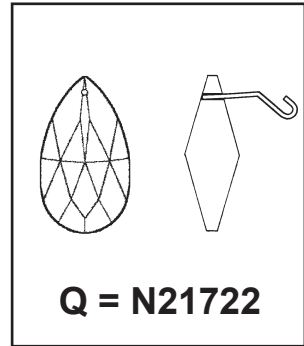
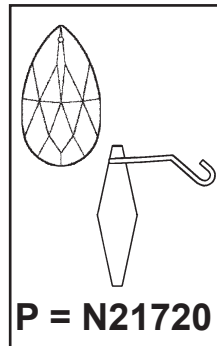

CRYSTAL BASKET DETAIL

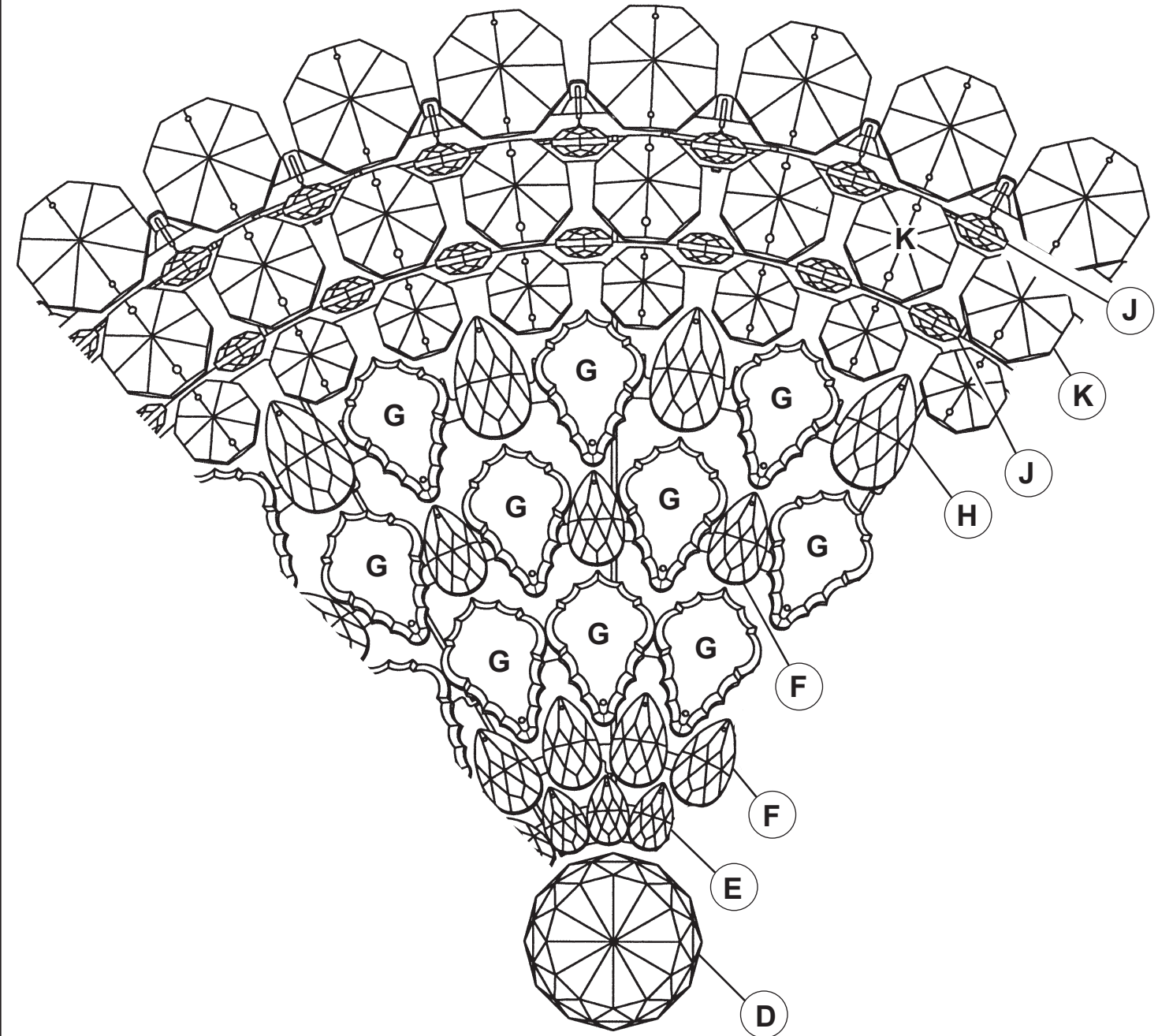



7

Install bulbs and be sure to test fixture BEFORE trimming.



You will need 10 - B10
25 Watts Recommended
40 Watts Max



You will need 3 - B8
25 Watts Recommended
40 Watts Max

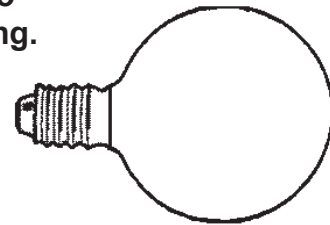

You will need 17 - G16-1/2
25 Watts Recommended
40 Watts Max

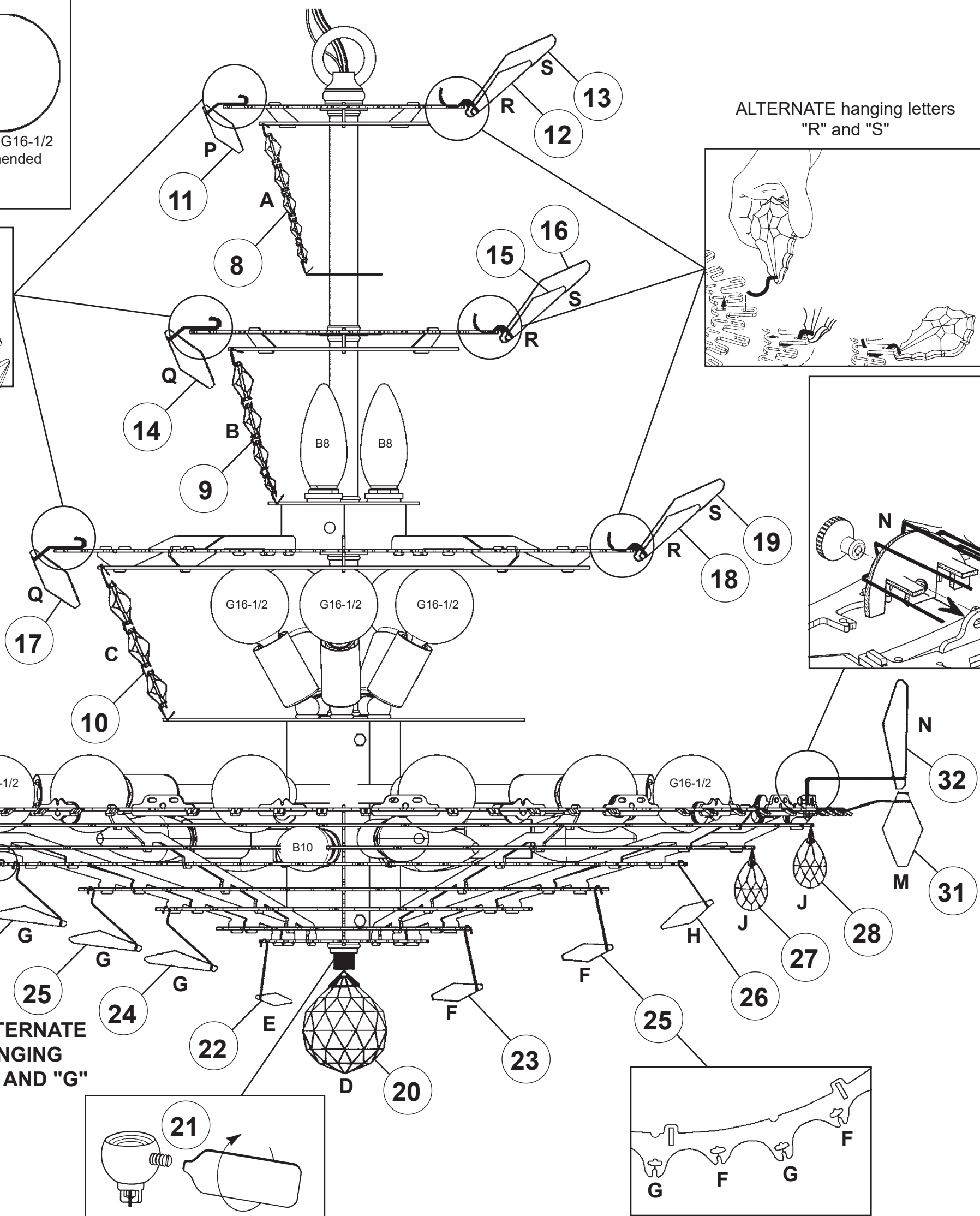
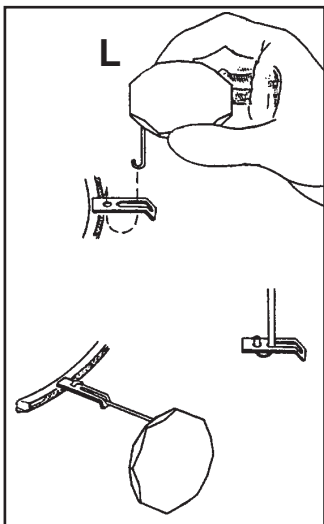
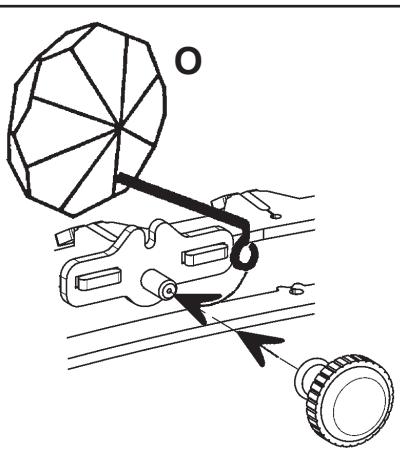
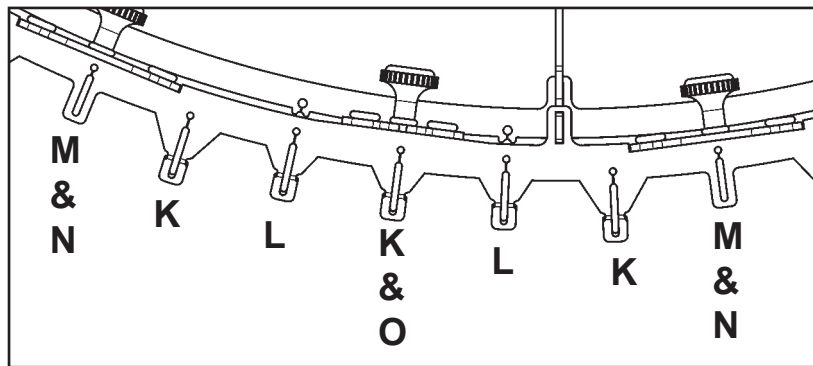
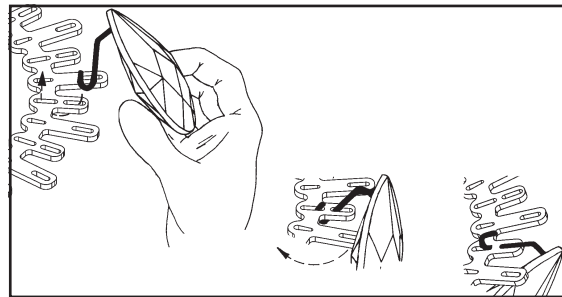

ALTERNATE hanging letters "R" and "S"

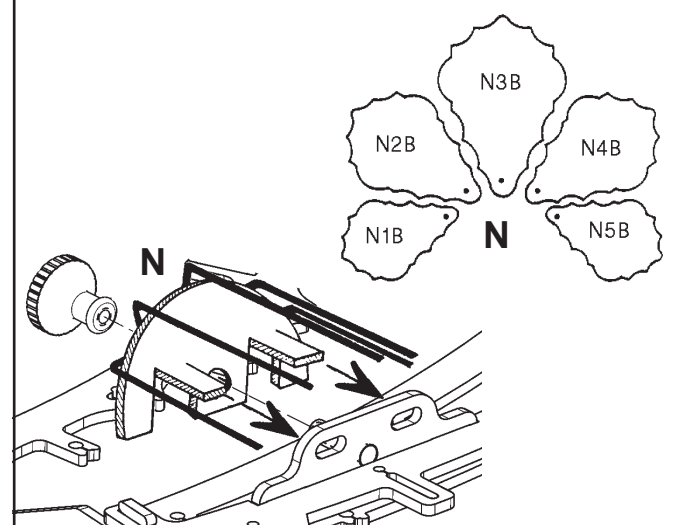
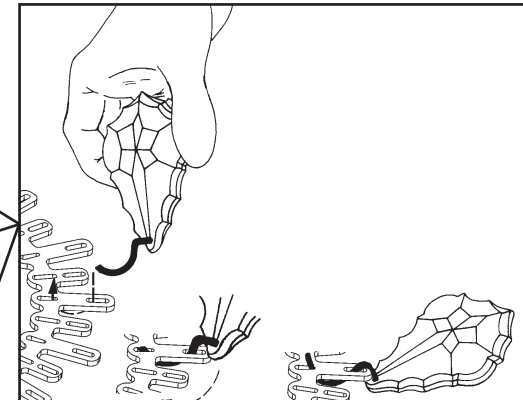

ALTERNATE HANGING "F" AND "G"

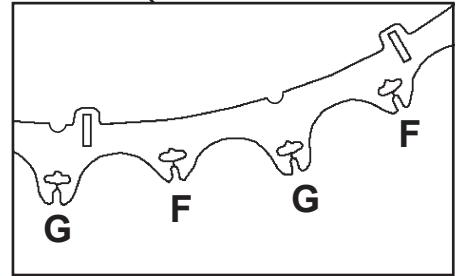
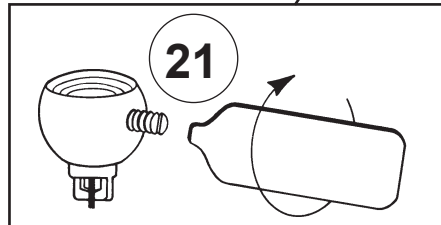

TRILLIANE 5856- __ __ R

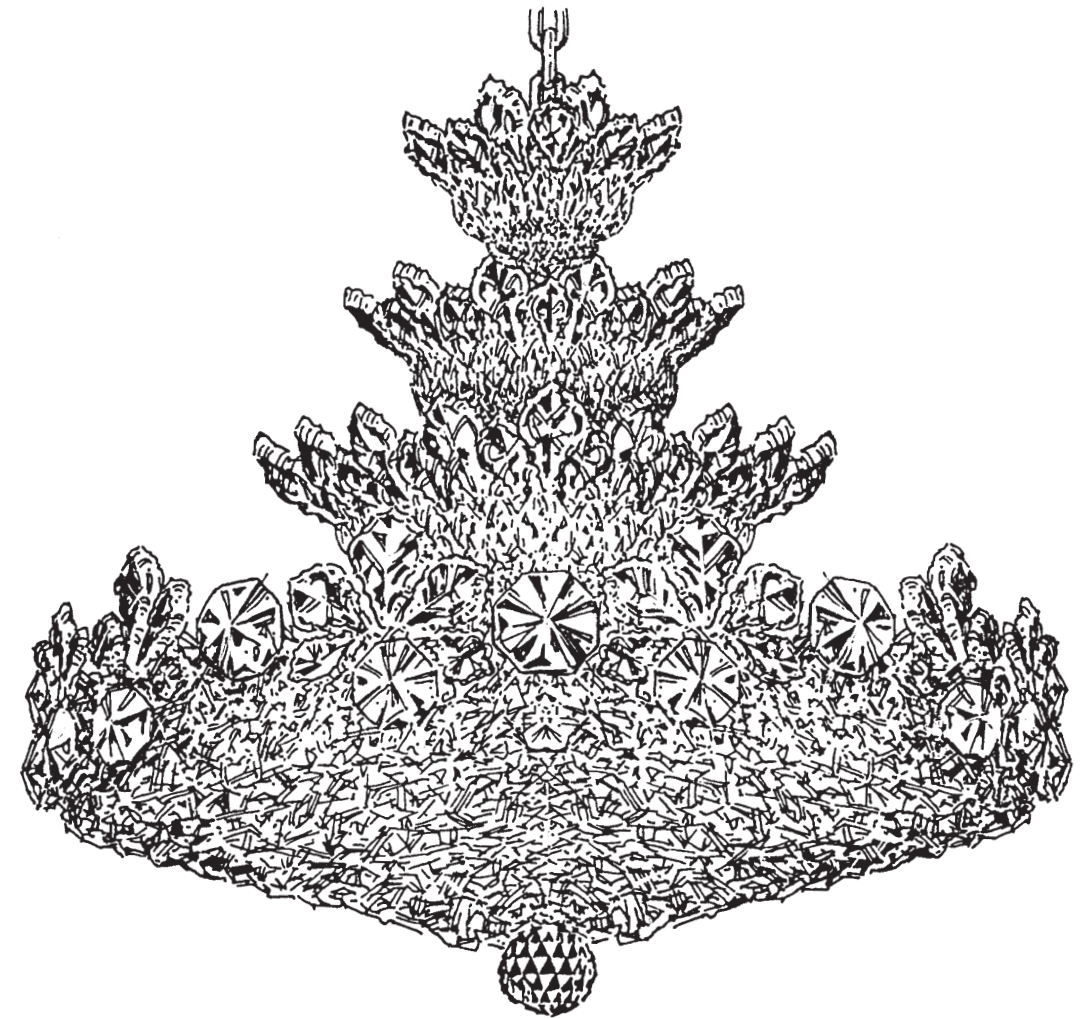











THIS DESIGN IS THE PROPRIETARY TRADE DRESS/TRADEMARK OF W SCHONBEK LLC.

30 Lights
Diameter: 30"
Body Length: 27"
Hanging Weight: 64 lbs.

 **SCHONBEK** | 1870

 **SCHONBEK** | 1870

								
MAX 40 W		110-120 V						

All electrical components must be installed by a licensed electrician in accordance with the National Electric Code and the appropriate local electrical codes.

WARNING: THIS LUMINAIRE MUST BE MOUNTED OR SUPPORTED INDEPENDENTLY OF AN OUTLET BOX.

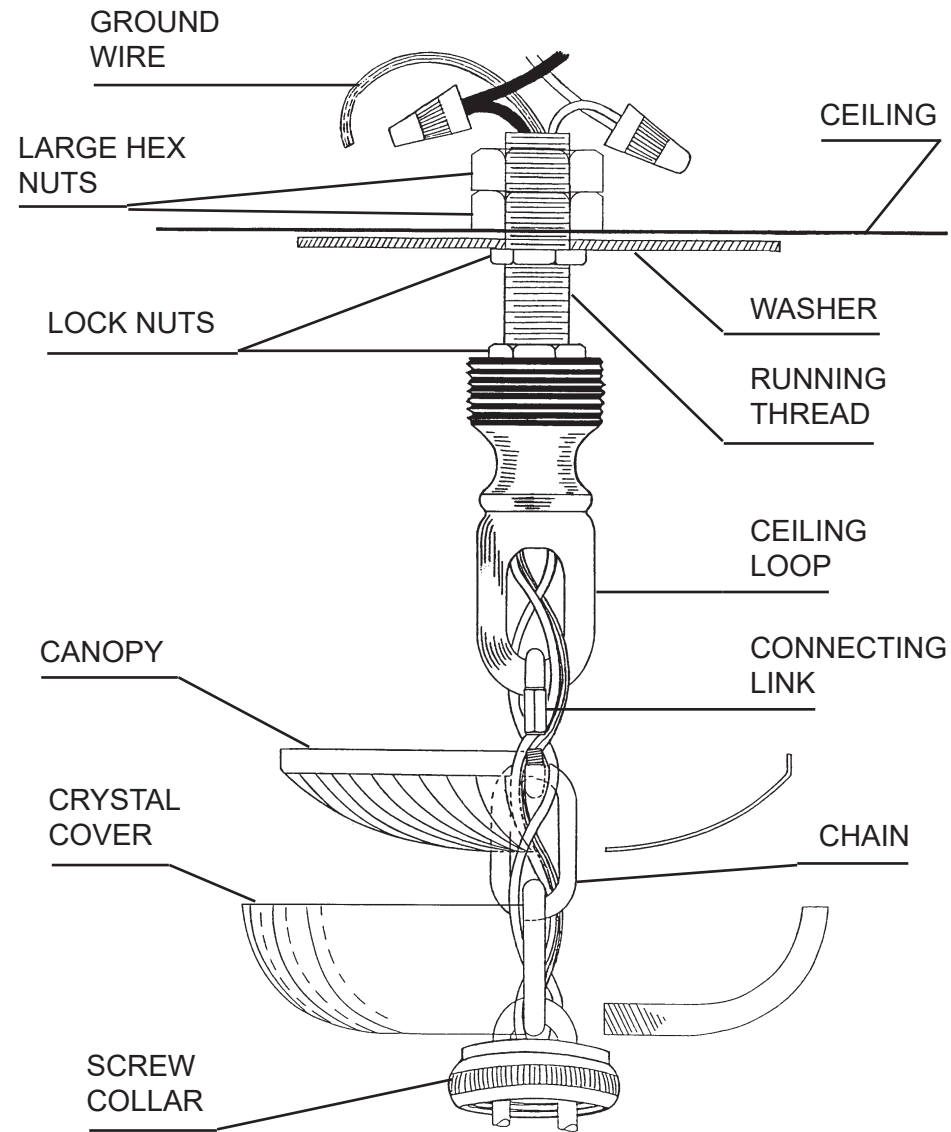

1 MAKE SURE POWER IS DISCONNECTED!!

2 Attach washer to supporting member in ceiling sufficient to support weight of fixture.

3 Slip screw collar, crystal cover and metal canopy over chain. Determine the suspension length of the fixture and cut chain, if necessary. Use two connecting links to attach chain to chandelier loop and ceiling loop.

4 Insert stem wire through chain and ceiling loop. Connect wires. Fixture **MUST** be grounded.

5 Check distance from ceiling to loop to assure canopy assembly will be flush against ceiling.

6 Attach canopy to ceiling with screw collar.

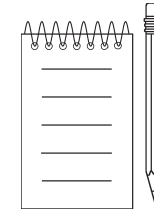

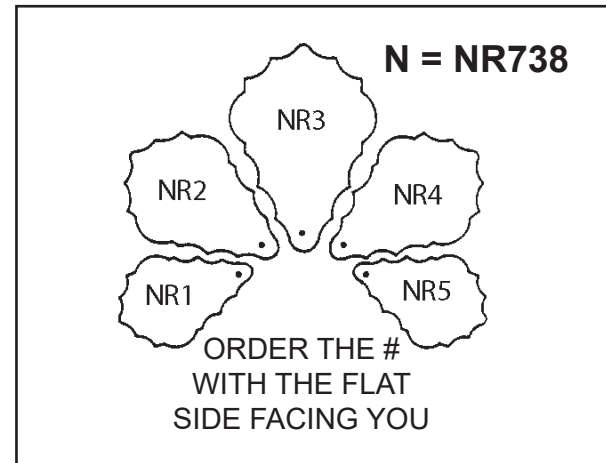
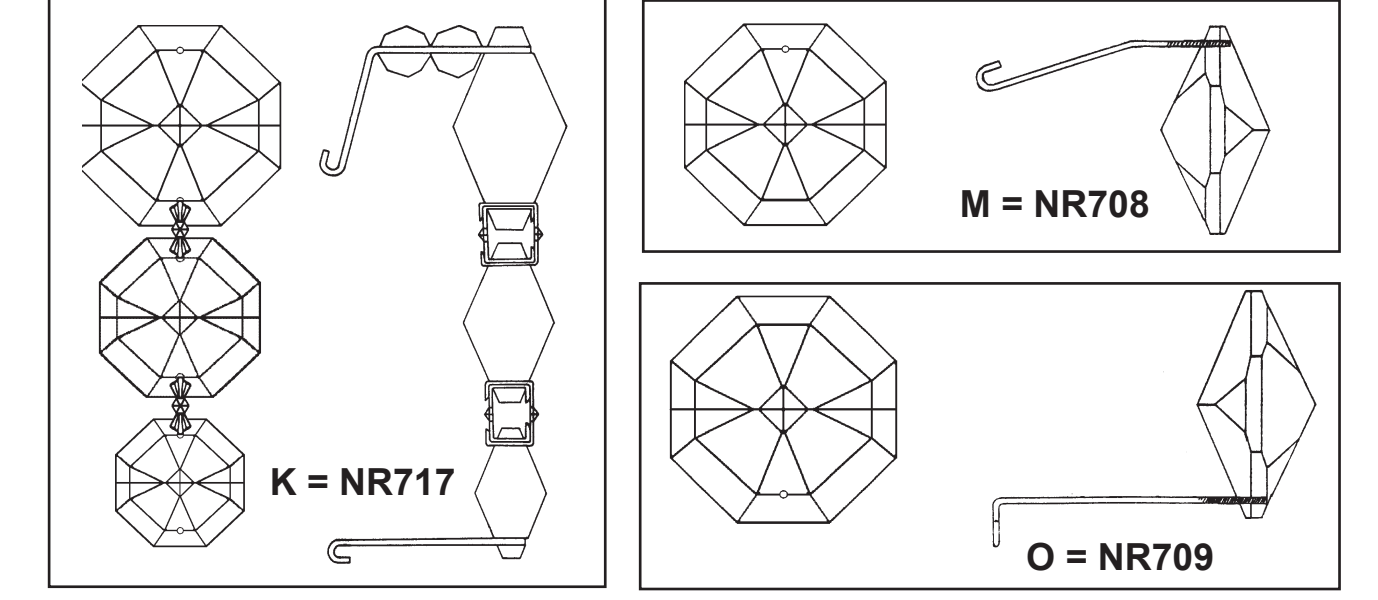
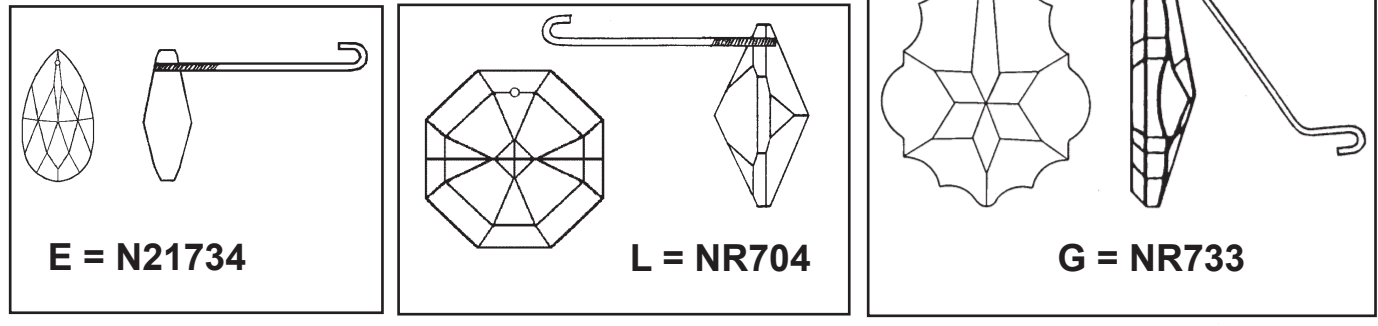
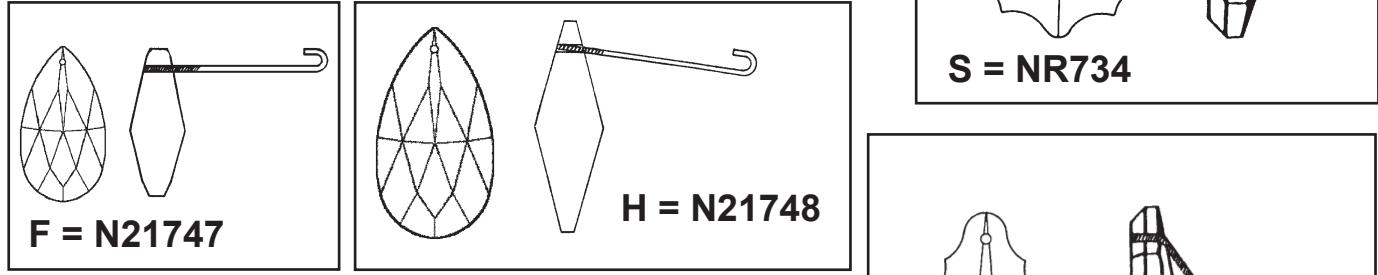
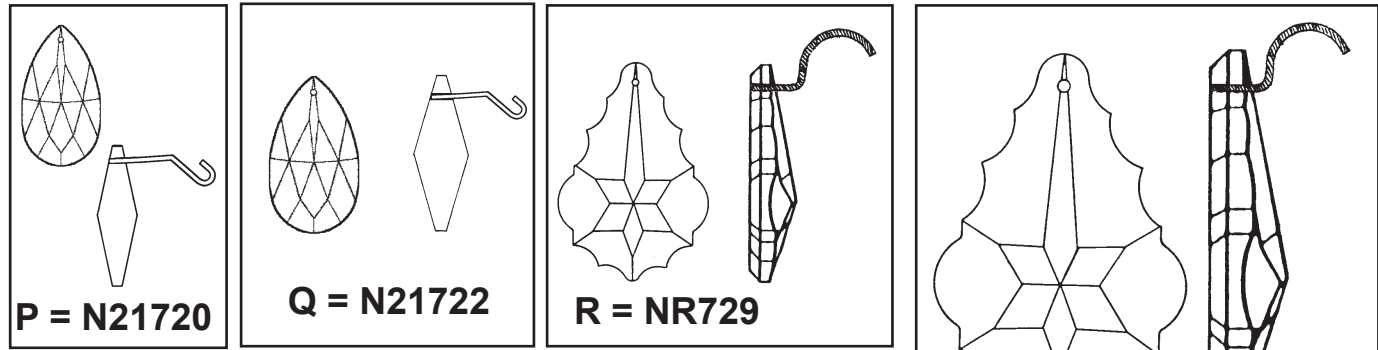

CRYSTAL BASKET DETAIL

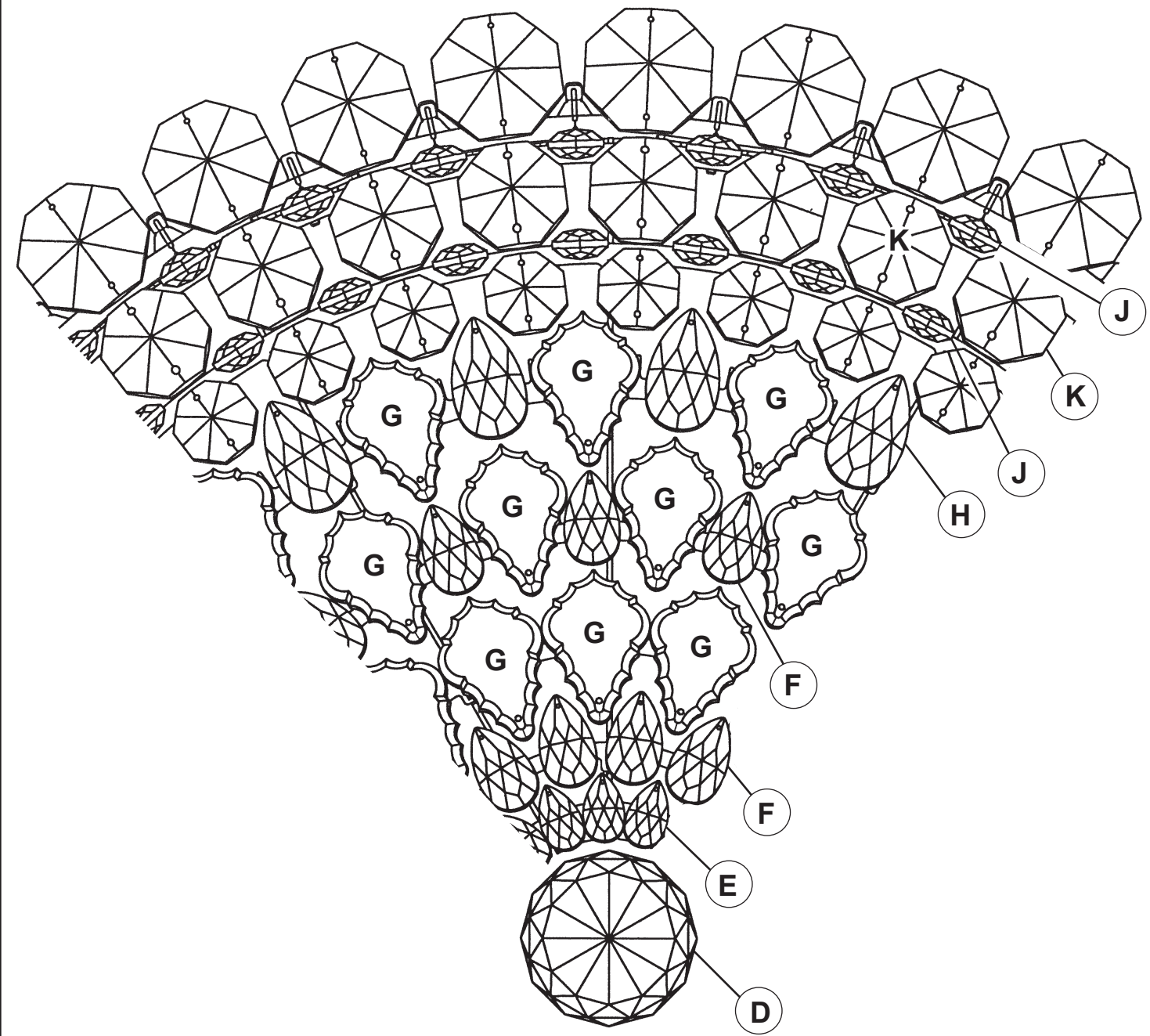



7

Install bulbs and be sure to test fixture BEFORE trimming.



You will need 10 - B10
25 Watts Recommended
40 Watts Max



You will need 3 - B8
25 Watts Recommended
40 Watts Max

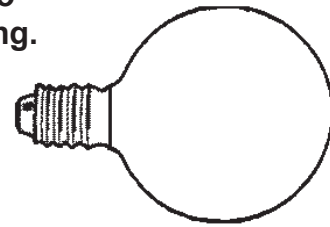

You will need 17 - G16-1/2
25 Watts Recommended
40 Watts Max

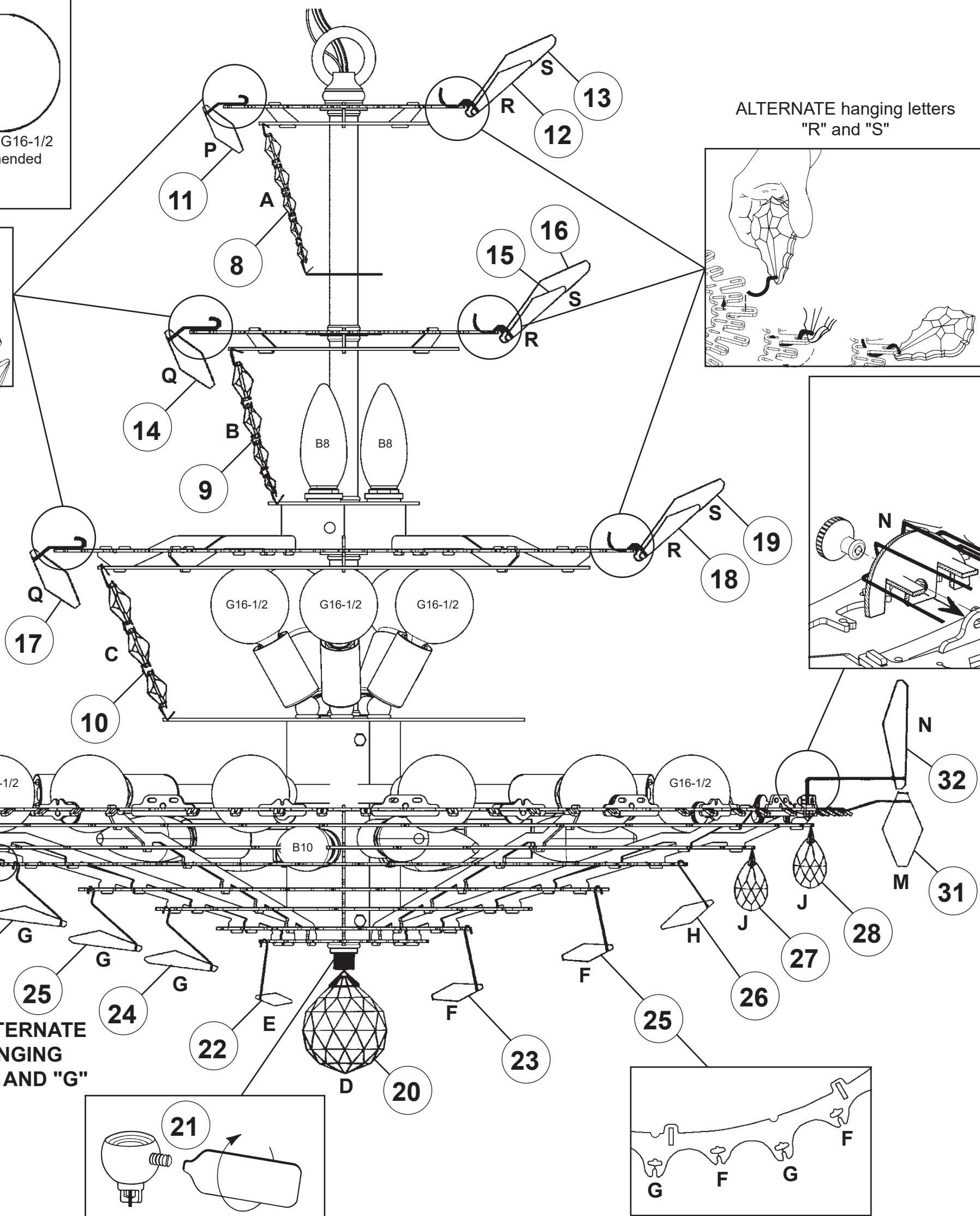
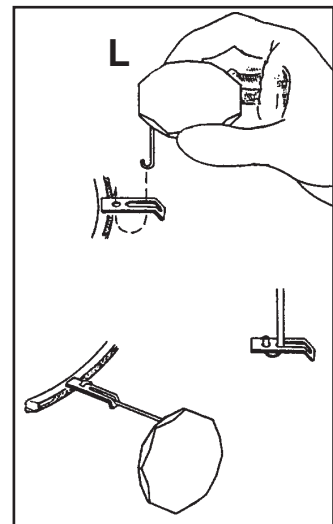
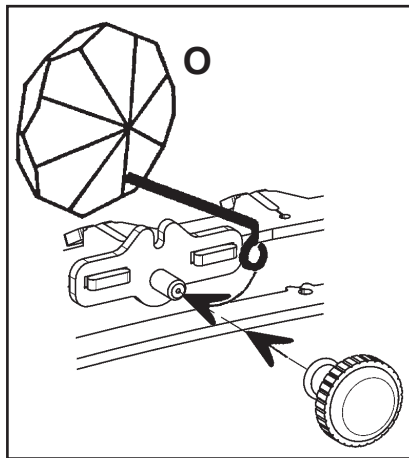
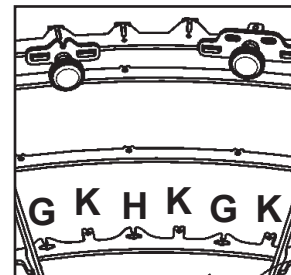
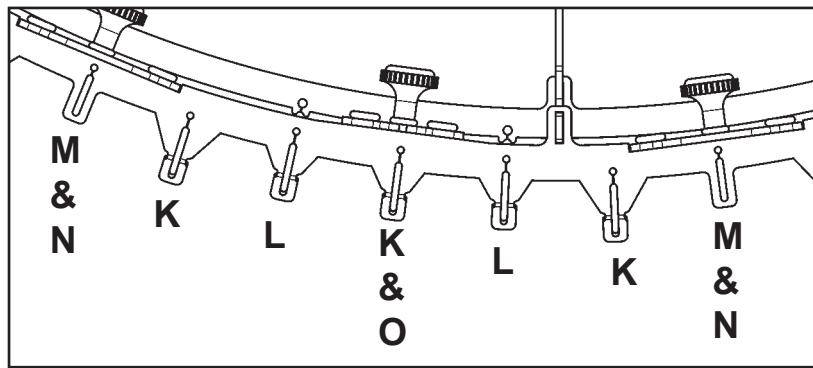
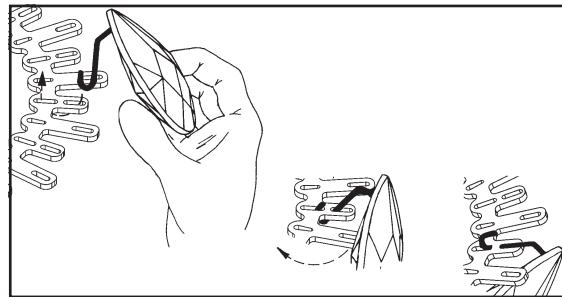

ALTERNATE hanging letters "R" and "S"

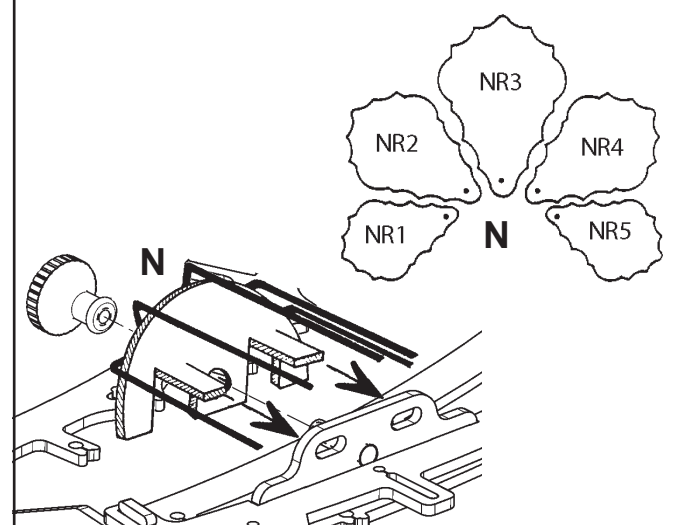
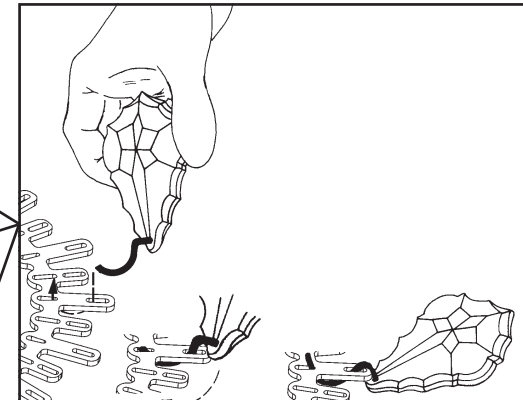

ALTERNATE HANGING "F" AND "G"

