

PETIT CRYSTAL DELUXE 5891-\_\_ \_\_O

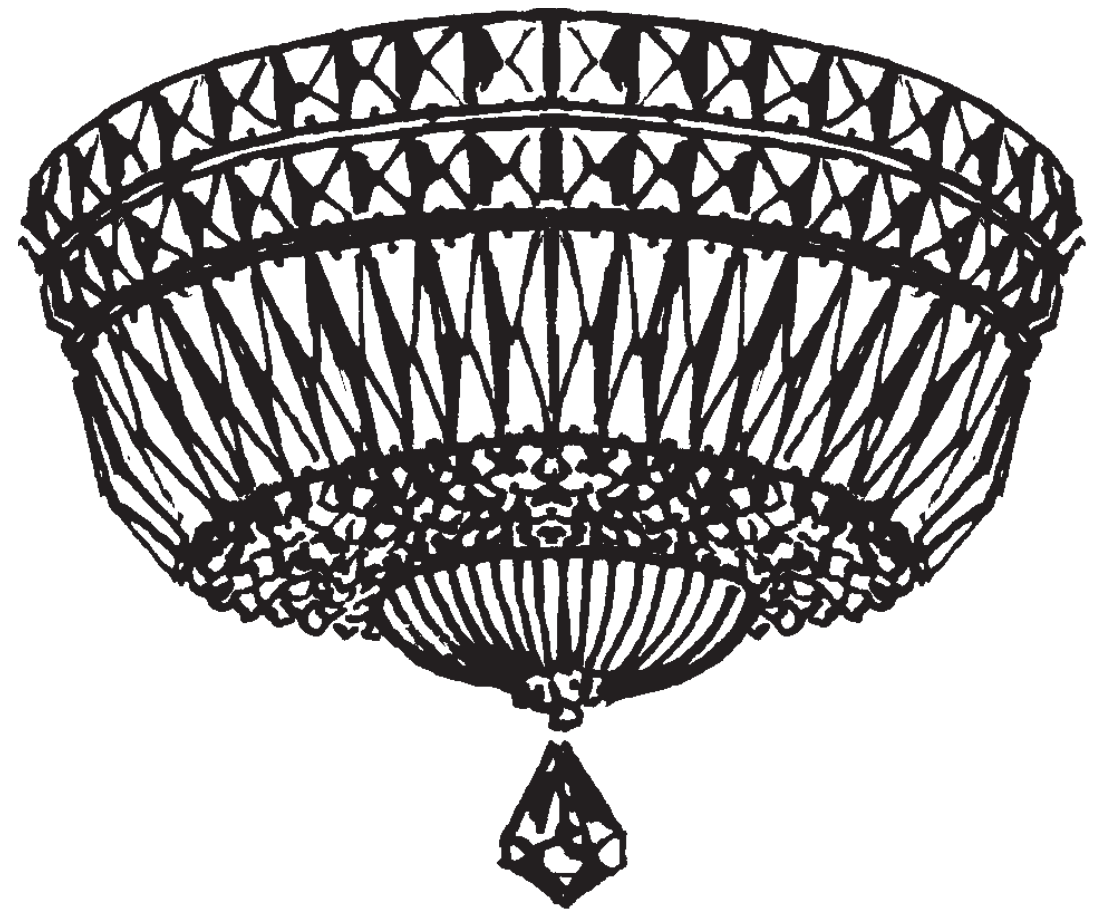











4 Lights  
Diameter: 10"  
Body Length: 7"  
Hanging Weight: 4 lbs.

**T**HIS DESIGN IS THE PROPRIETARY  
TRADE DRESS/TRADEMARK OF  
W SCHONBEK LLC.

 **SCHONBEK** | 1870

 **SCHONBEK** | 1870

								
MAX 40 W		110-120 V						

All electrical components must be installed by a licensed electrician in accordance with the National Electric Code and the appropriate local electrical codes.

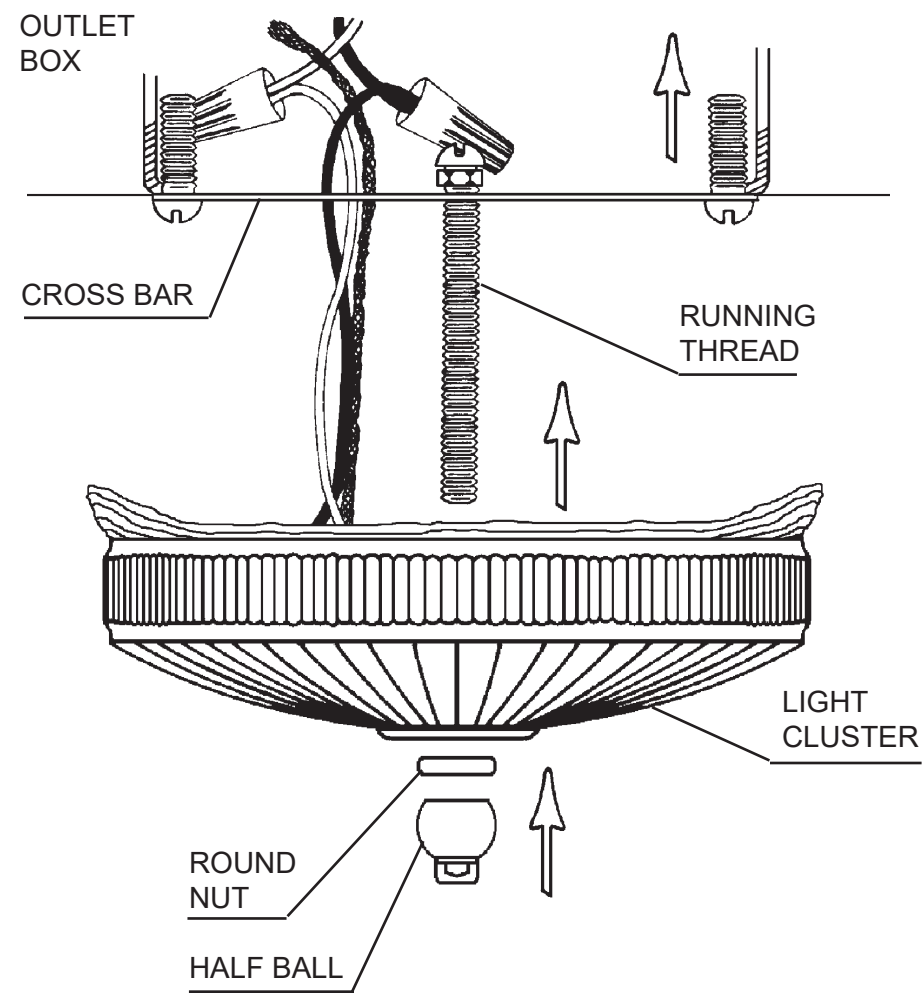

- 1** Remove crossbar from light cluster and attach to outlet box.
- 2** Feed stem wires through crossbar and attach to power wires in outlet box.
- 3** Place light cluster over thread attached to crossbar and secure with round nut and half ball.

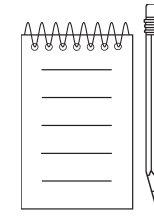

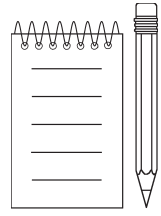

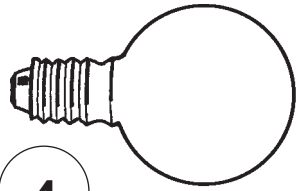

4

You will need 4 - G16-1/2  
25 Watts Recommended  
40 Watts Max  
MIN 90°C SUPPLY  
CONDUCTORS

Install bulbs and be sure  
to test fixture BEFORE  
trimming.



### CRYSTAL CHAIN ASSEMBLY

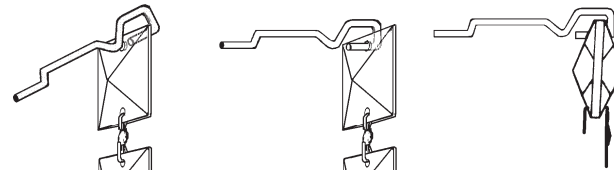

NOTE: There will be a slight resistance when putting the pin through the top crystal. Do NOT bend pin or try to scrape out crystal hole. The resistance holds the crystal chain on the pin.

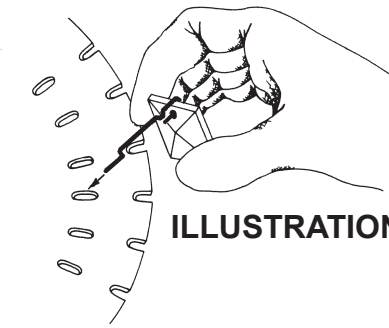
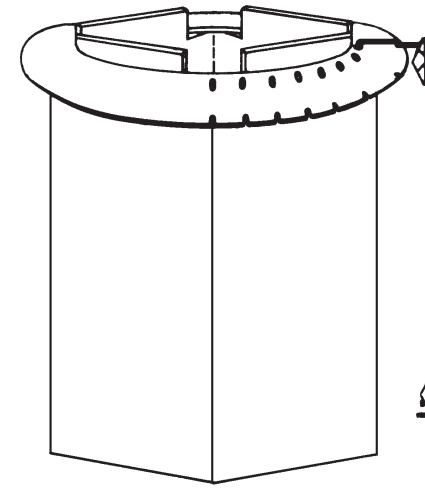

ILLUSTRATION 1



ILLUSTRATION 2

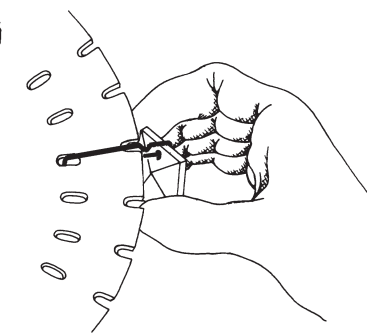

ILLUSTRATION 3

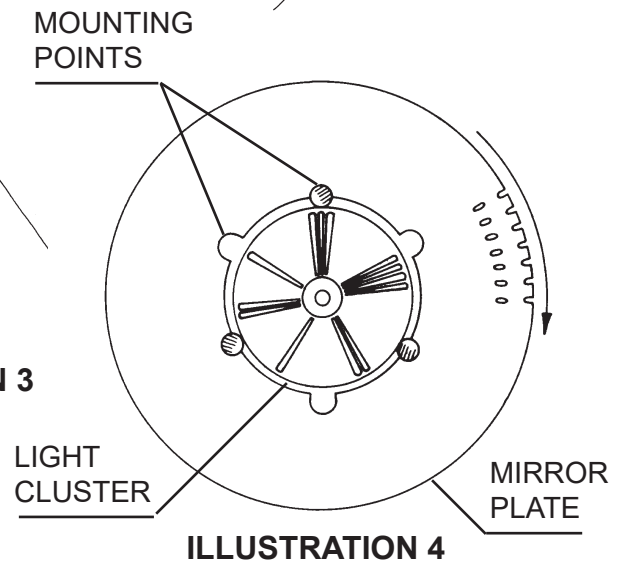
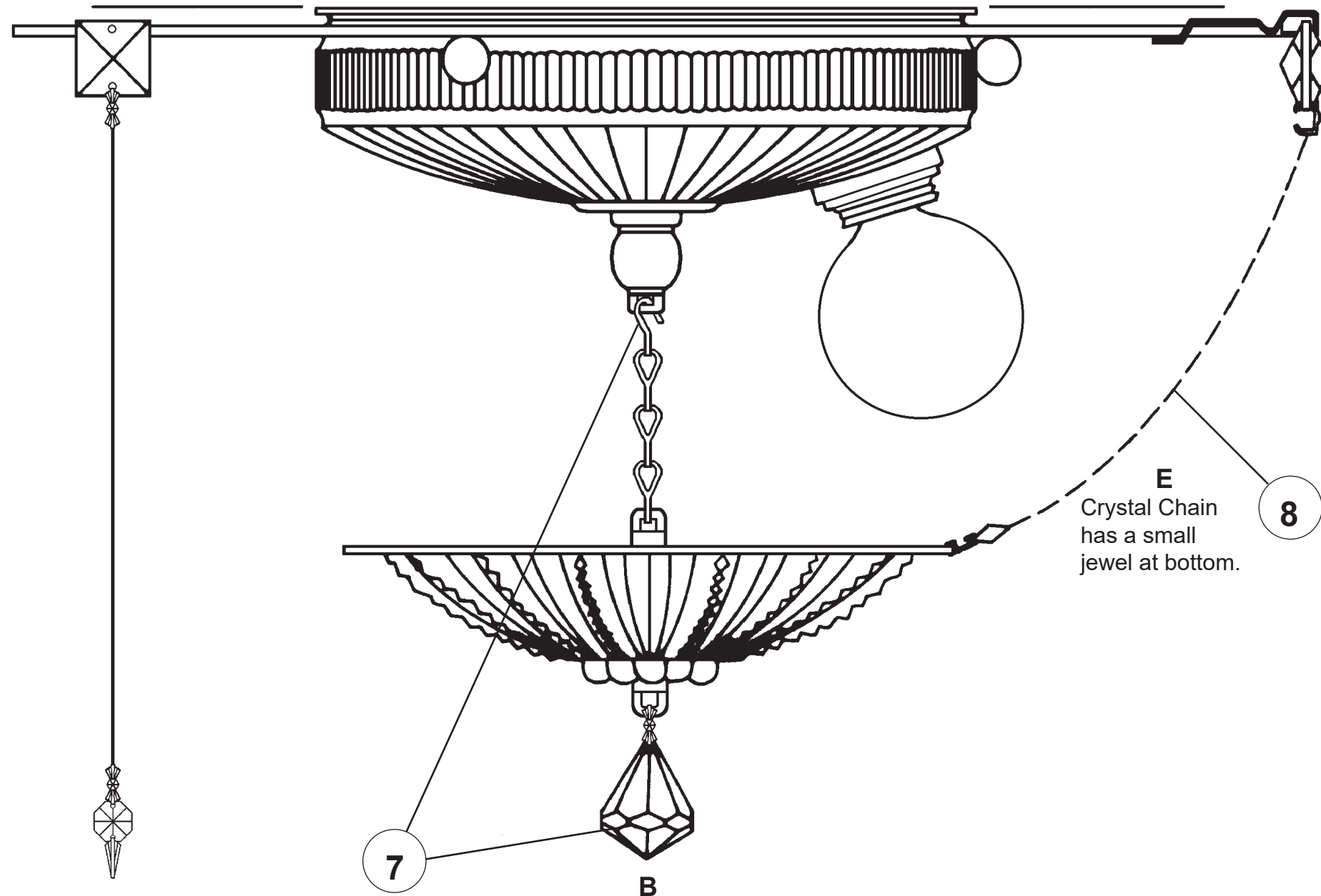

ILLUSTRATION 4

**5** Assemble all crystal chains and pins provided. See "Crystal Chain Assembly" above. Set mirror plate on cardboard stand. Hook all Crystal Chains "E" into slots in the mirror plate so the metal accessories face outwards and the square jewel is on the upper end. See illustrations #1 - #3. NOTE: Allow ends with small jewels to hang loose.

**6** Align holes in mirror plate with the balls on the frame, raise mirror plate over balls, then turn mirror clockwise until holes are halfway between balls. See illustration #4.



# PETIT CRYSTAL DELUXE 5891-\_\_ \_\_R

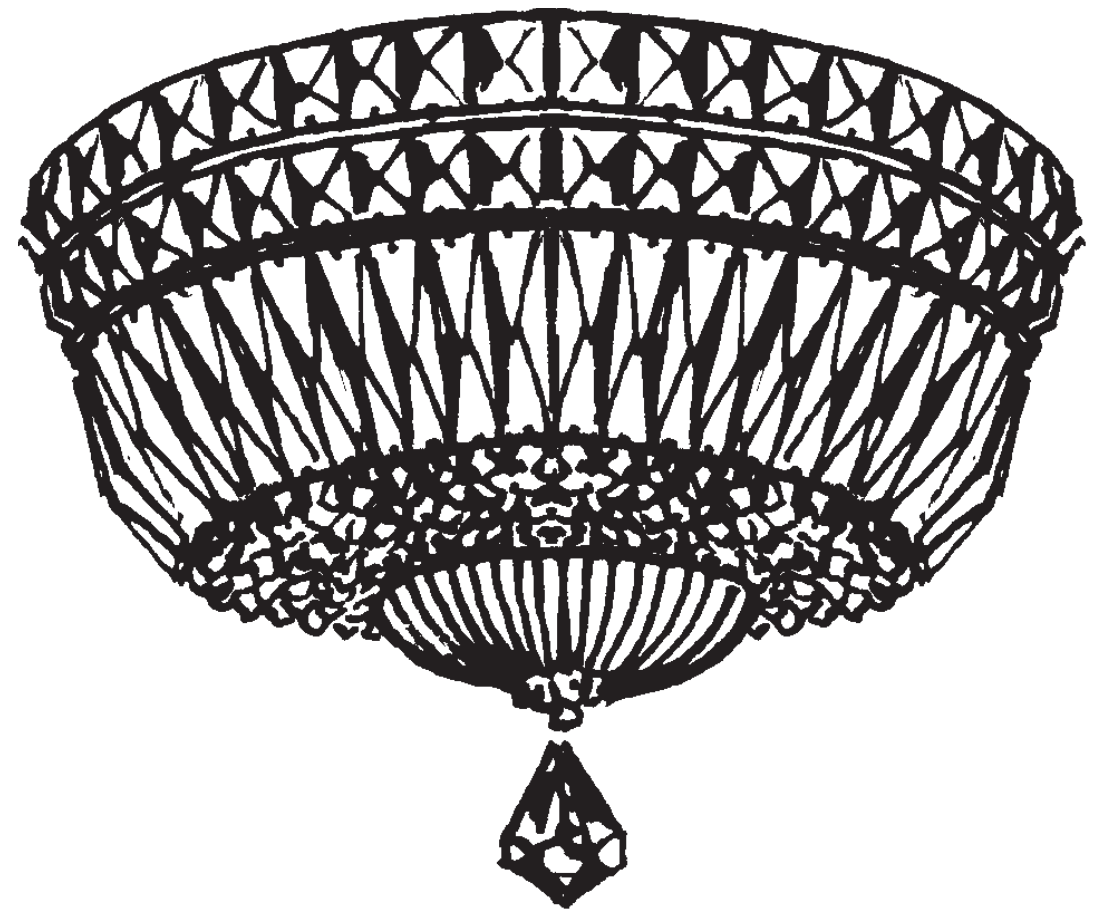











4 Lights  
Diameter: 10"  
Body Length: 7"  
Hanging Weight: 4 lbs.

**T**HIS DESIGN IS THE PROPRIETARY  
TRADE DRESS/TRADEMARK OF  
W SCHONBEK LLC.

 **SCHONBEK** | 1870

 **SCHONBEK** | 1870

								
MAX 40 W		110-120 V						

All electrical components must be installed by a licensed electrician in accordance with the National Electric Code and the appropriate local electrical codes.

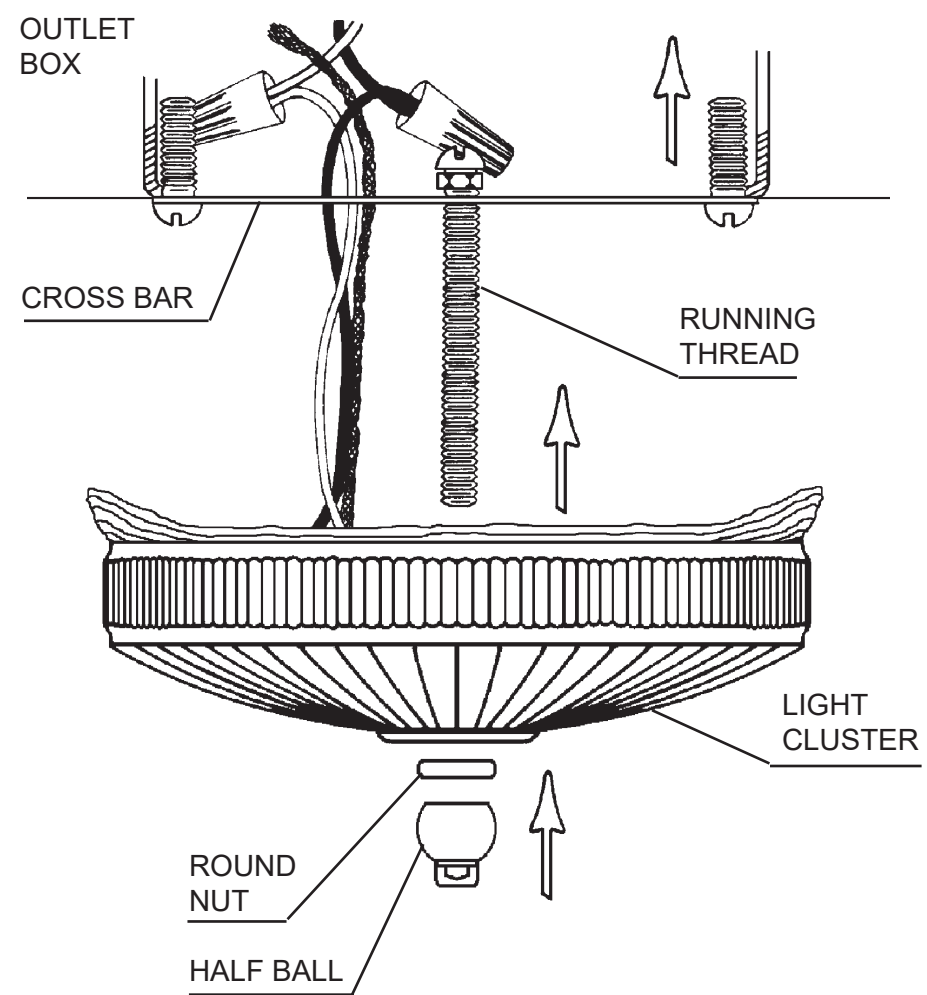

- 1** Remove crossbar from light cluster and attach to outlet box.
- 2** Feed stem wires through crossbar and attach to power wires in outlet box.
- 3** Place light cluster over thread attached to crossbar and secure with round nut and half ball.

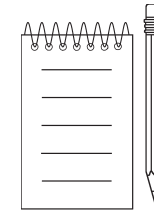

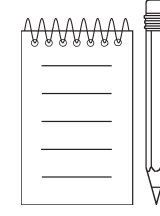
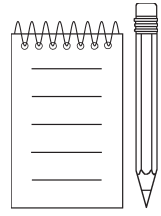

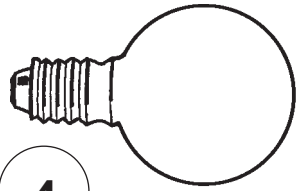

4

You will need 4 - G16-1/2  
25 Watts Recommended  
40 Watts Max  
MIN 90°C SUPPLY  
CONDUCTORS

Install bulbs and be sure  
to test fixture BEFORE  
trimming.

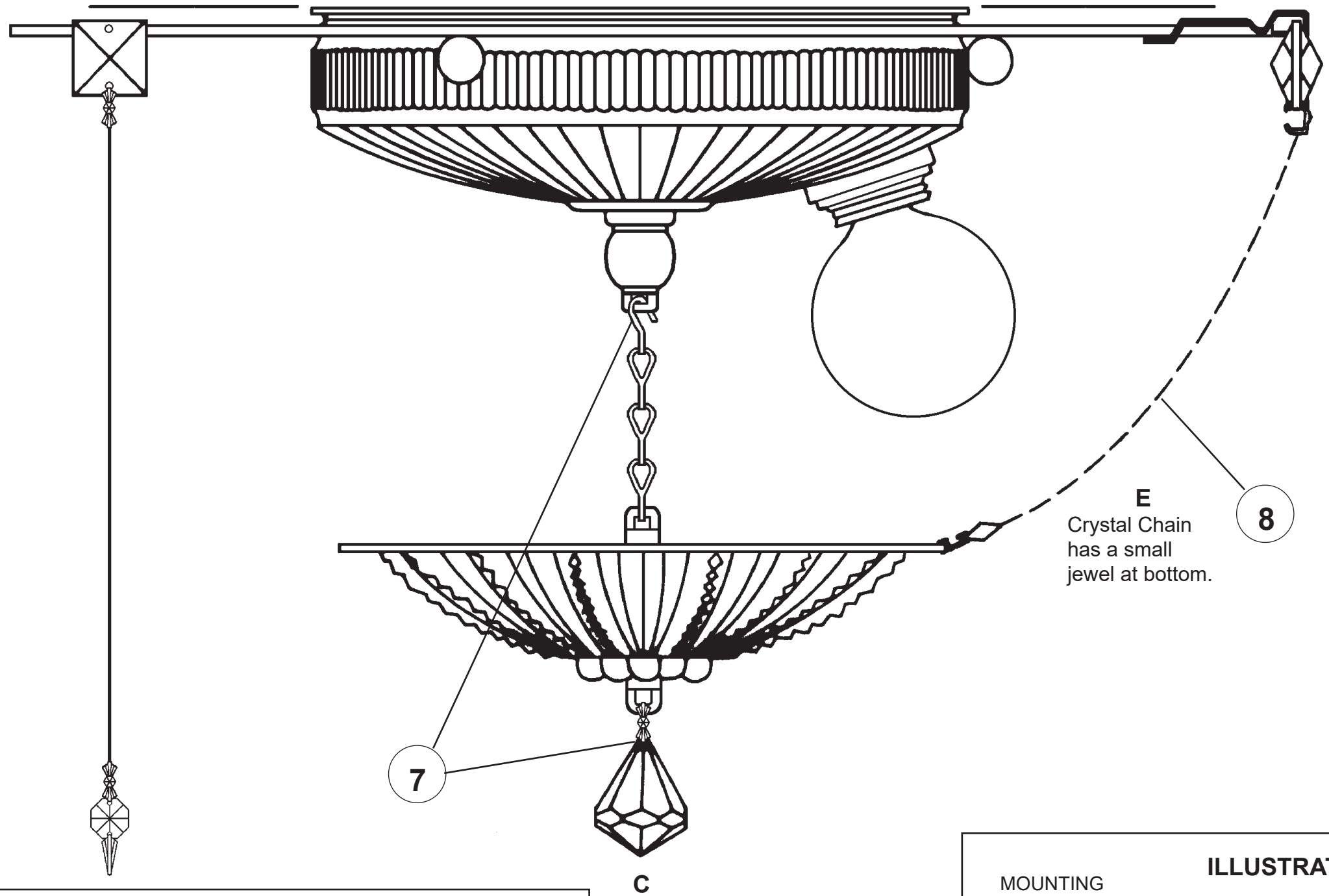

E  
Crystal Chain  
has a small  
jewel at bottom.

8

7

C

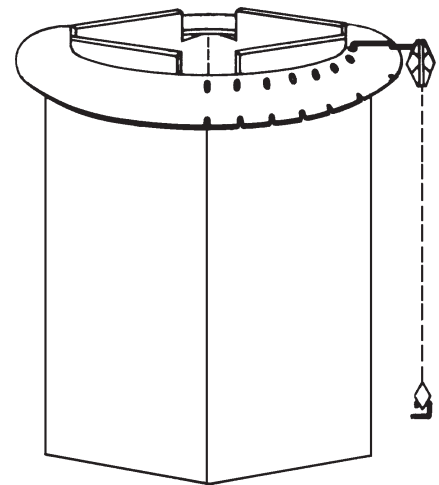

5 Set mirror plate on cardboard stand. Hook all Crystal Chains "E" into slots in the mirror plate so the metal accessories face outwards and the square jewel is on the upper end. See illustrations #1 - #3. NOTE: Allow ends with small jewels to hang loose.

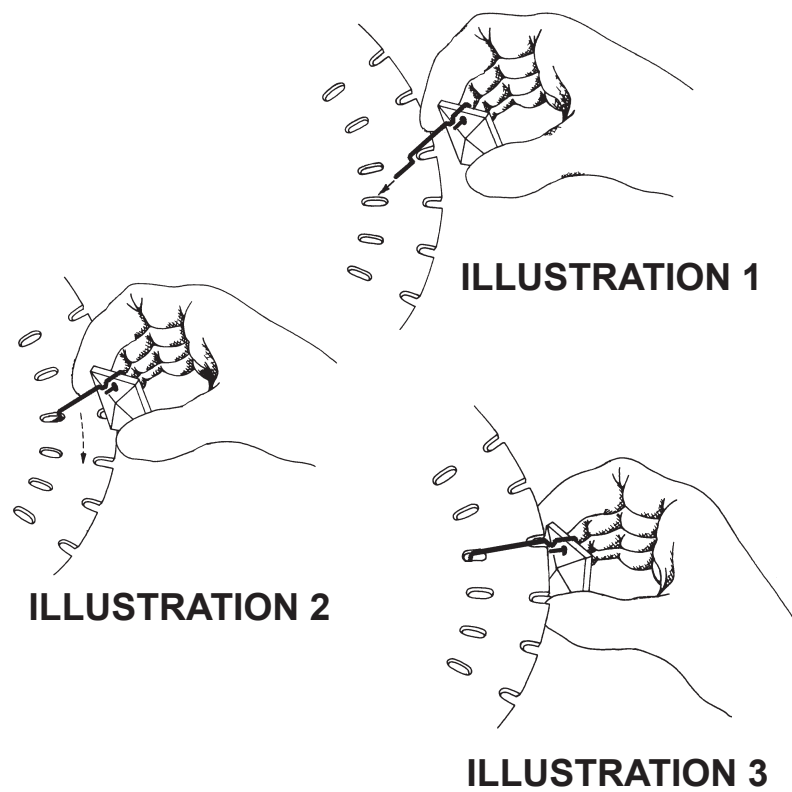

ILLUSTRATION 1

ILLUSTRATION 2

ILLUSTRATION 3

ILLUSTRATION 4

MOUNTING  
POINTS

LIGHT  
CLUSTER

MIRROR  
PLATE

6 Align holes in mirror plate with the balls on the light cluster, raise mirror plate over balls, then turn mirror clockwise until holes are halfway between balls. See illustration #4.



PETIT CRYSTAL DELUXE 5891-\_\_ \_\_S

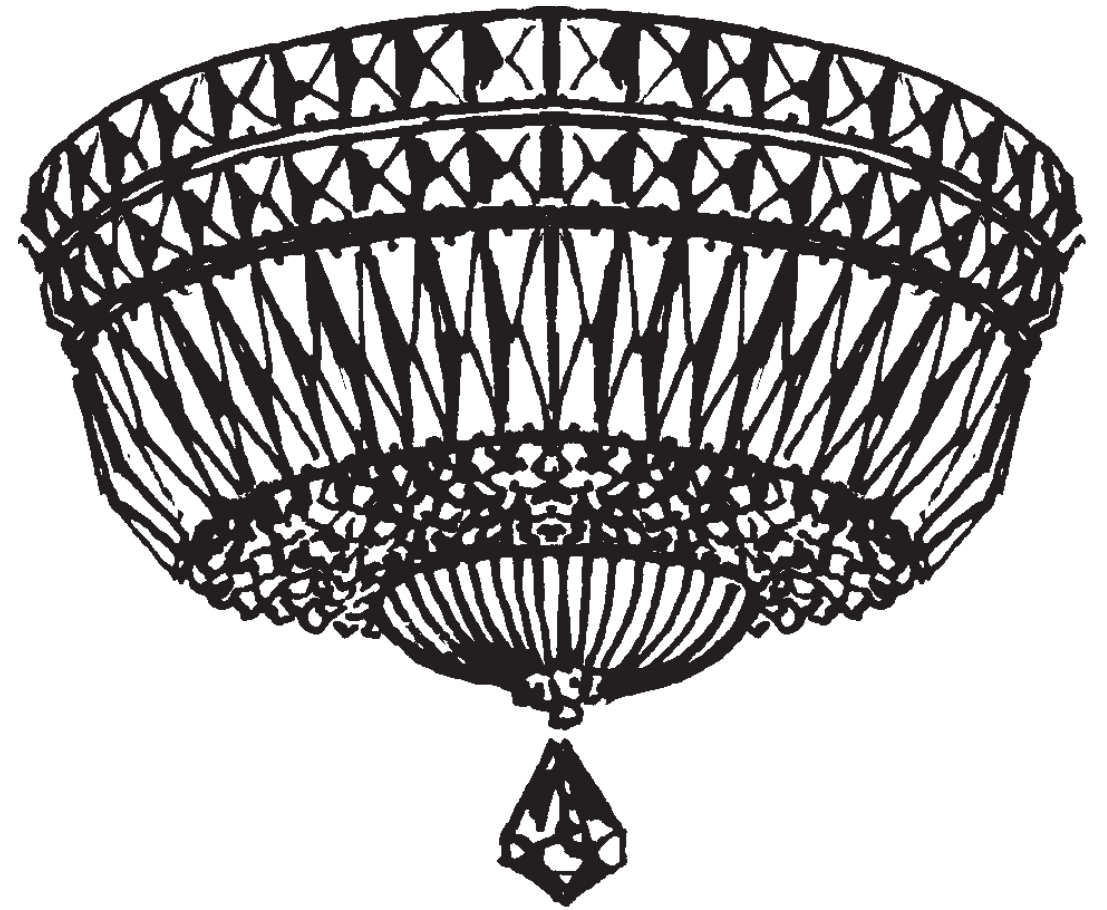











4 Lights  
Diameter: 10"  
Body Length: 7"  
Hanging Weight: 4 lbs.

**T**HIS DESIGN IS THE PROPRIETARY  
TRADE DRESS/TRADEMARK OF  
W SCHONBEK LLC.

 **SCHONBEK** | 1870

 **SCHONBEK** | 1870

								
MAX 40 W		110-120 V						

All electrical components must be installed by a licensed electrician in accordance with the National Electric Code and the appropriate local electrical codes.

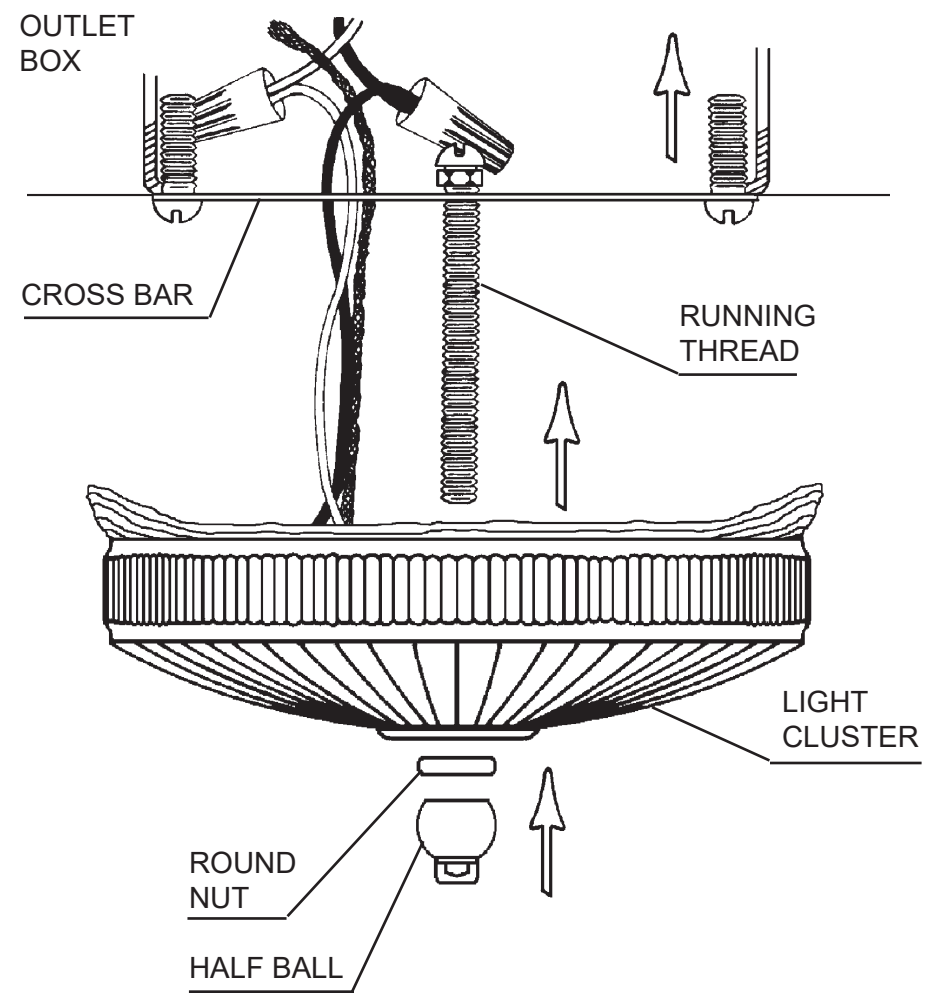

- 1** Remove crossbar from light cluster and attach to outlet box.
- 2** Feed stem wires through crossbar and attach to power wires in outlet box.
- 3** Place light cluster over thread attached to crossbar and secure with round nut and half ball.

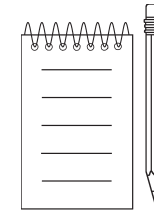

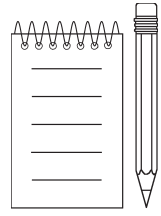

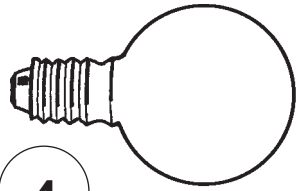

4

You will need 4 - G16-1/2  
25 Watts Recommended  
40 Watts Max  
MIN 90°C SUPPLY  
CONDUCTORS

Install bulbs and be sure  
to test fixture BEFORE  
trimming.

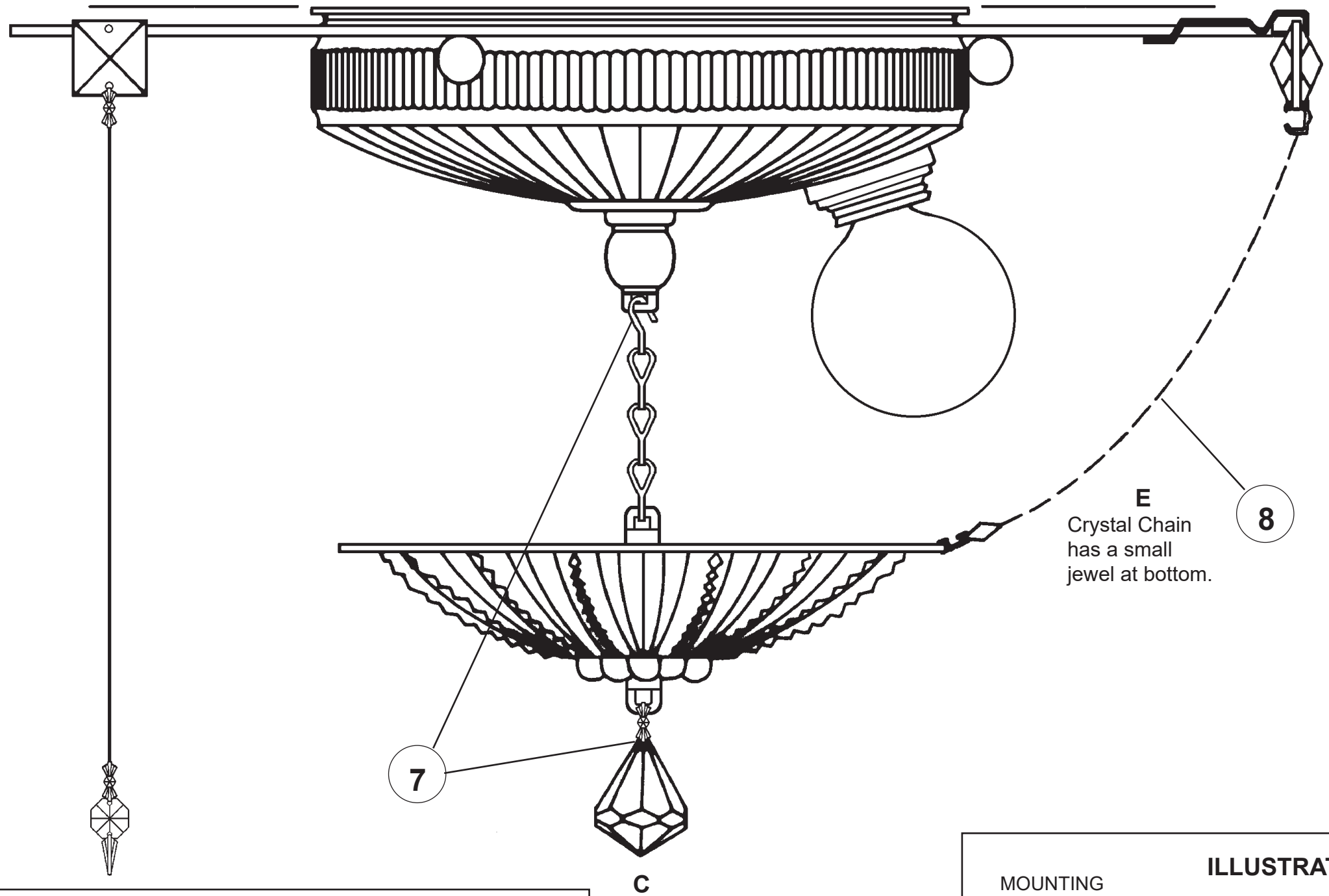

E  
Crystal Chain  
has a small  
jewel at bottom.

8

7

C

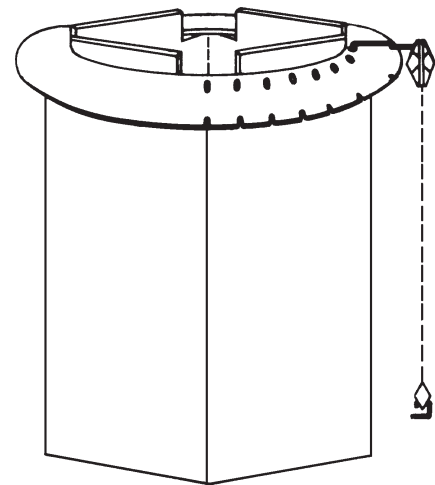

5 Set mirror plate on cardboard stand. Hook all Crystal Chains "E" into slots in the mirror plate so the metal accessories face outwards and the square jewel is on the upper end. See illustrations #1 - #3. NOTE: Allow ends with small jewels to hang loose.

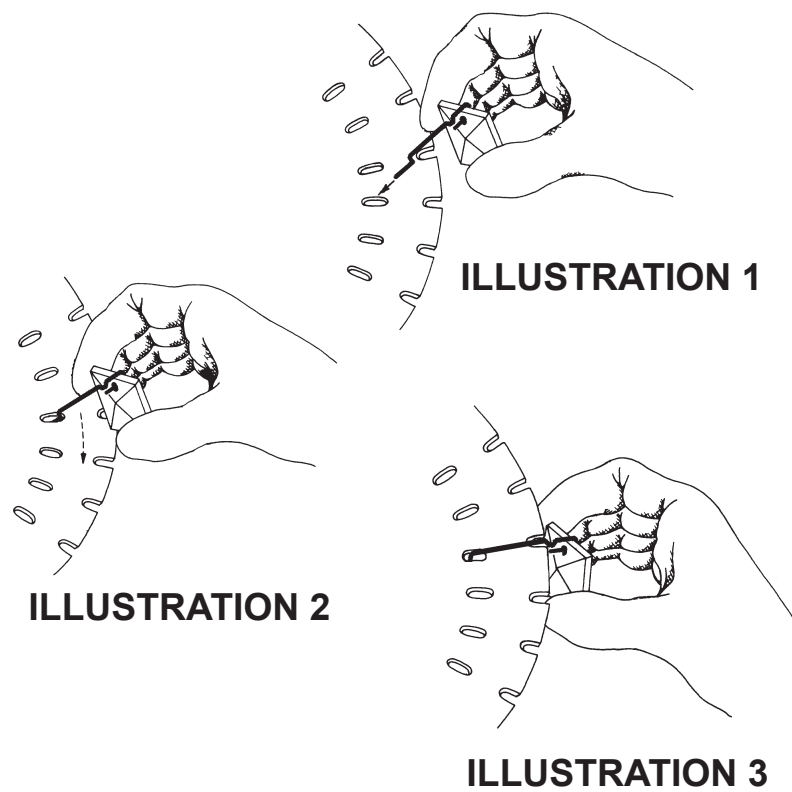

ILLUSTRATION 1

ILLUSTRATION 2

ILLUSTRATION 3

ILLUSTRATION 4

MOUNTING  
POINTS

LIGHT  
CLUSTER

MIRROR  
PLATE

6 Align holes in mirror plate with the balls on the light cluster, raise mirror plate over balls, then turn mirror clockwise until holes are halfway between balls. See illustration #4.