

PETIT CRYSTAL DELUXE 5893-__ __O

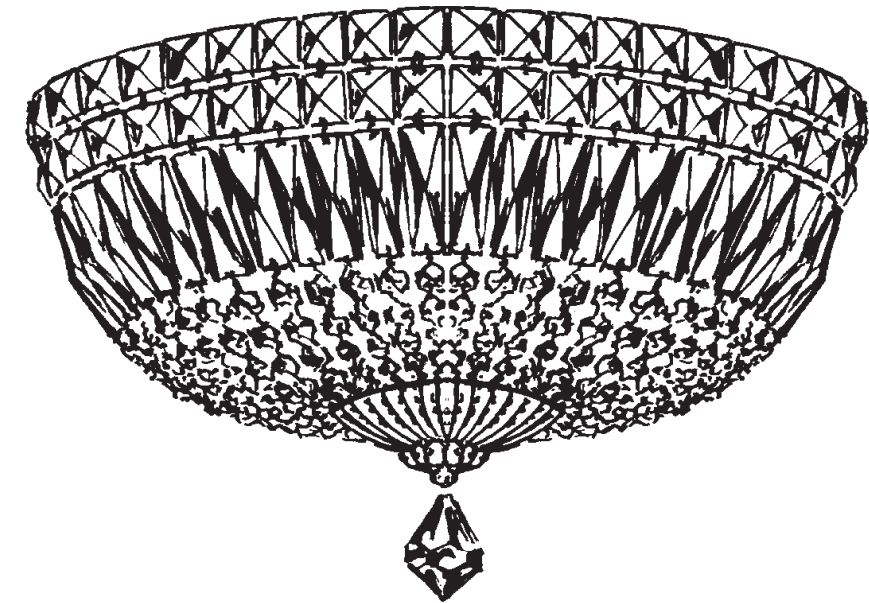











 **SCHONBEK** | 1870

THIS DESIGN IS THE PROPRIETARY
TRADE DRESS/TRADEMARK OF
W SCHONBEK LLC.

5 Lights
Diameter: 14"
Body Length: 8"
Hanging Weight: 7 lbs.

 **SCHONBEK** | 1870

								
MAX 40 W	110-120 V							

All electrical components must be installed by a licensed electrician in accordance with the National Electric Code and the appropriate local electrical codes.

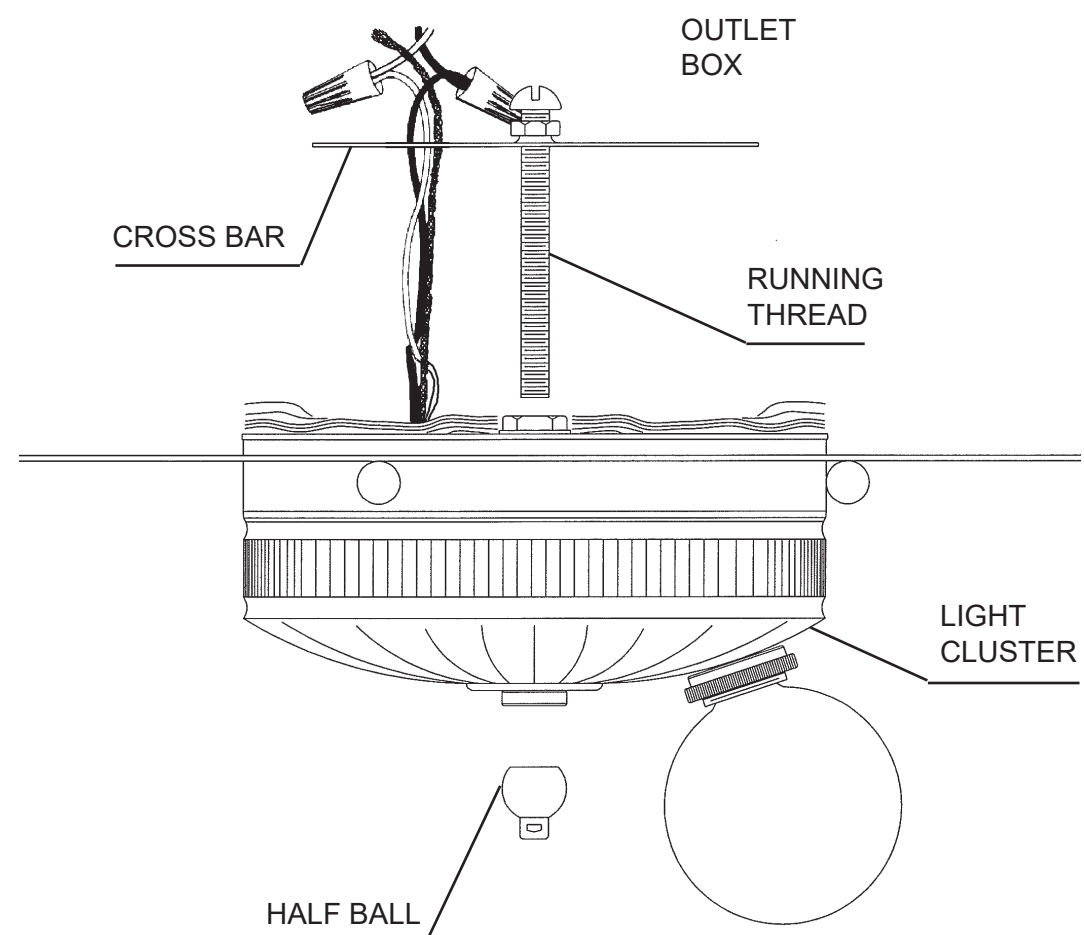

- 1** Remove crossbar from light cluster and attach to outlet box.
- 2** Feed stem wires through crossbar and attach to power wires in outlet box.
- 3** Place light cluster over thread attached to crossbar and secure with half ball.

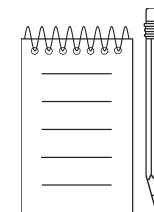

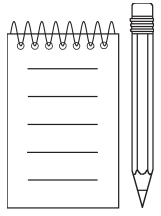

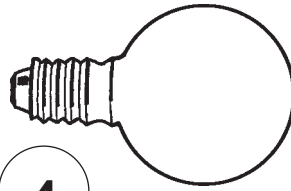

4

You will need 5 - G16-1/2
25 Watts Recommended
40 Watts Max
MIN 90°C SUPPLY
CONDUCTORS

Install bulbs and be sure
to test fixture **BEFORE**
trimming.



CRYSTAL CHAIN ASSEMBLY

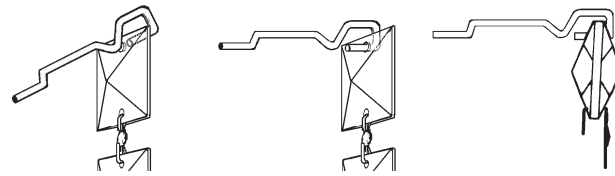

NOTE: There will be a slight resistance when putting the pin through the top crystal. Do NOT bend pin or try to scrape out crystal hole. The resistance holds the crystal chain on the pin.

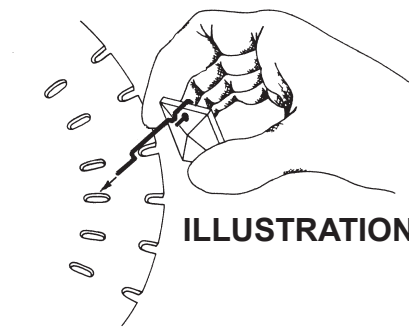
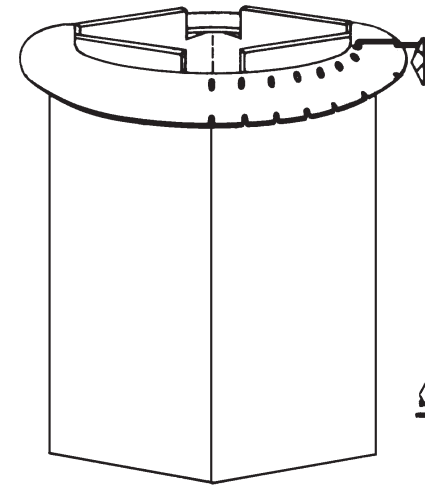

ILLUSTRATION 1



ILLUSTRATION 2

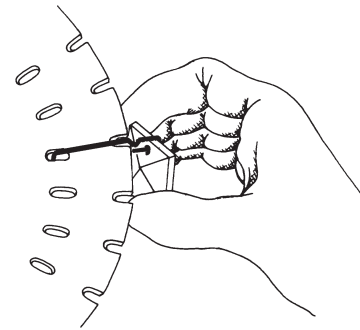

ILLUSTRATION 3

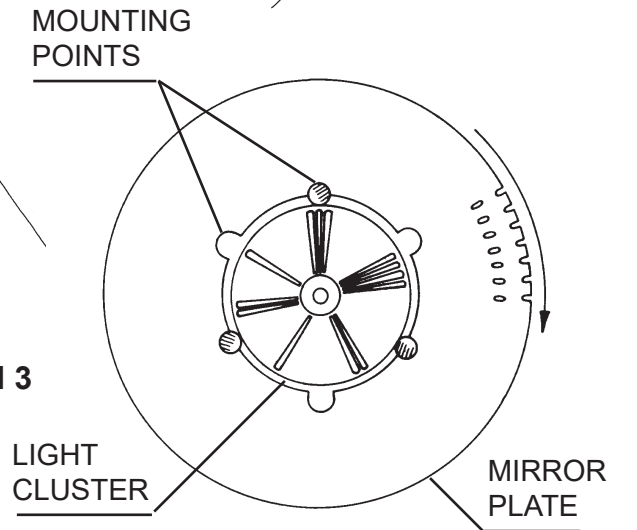
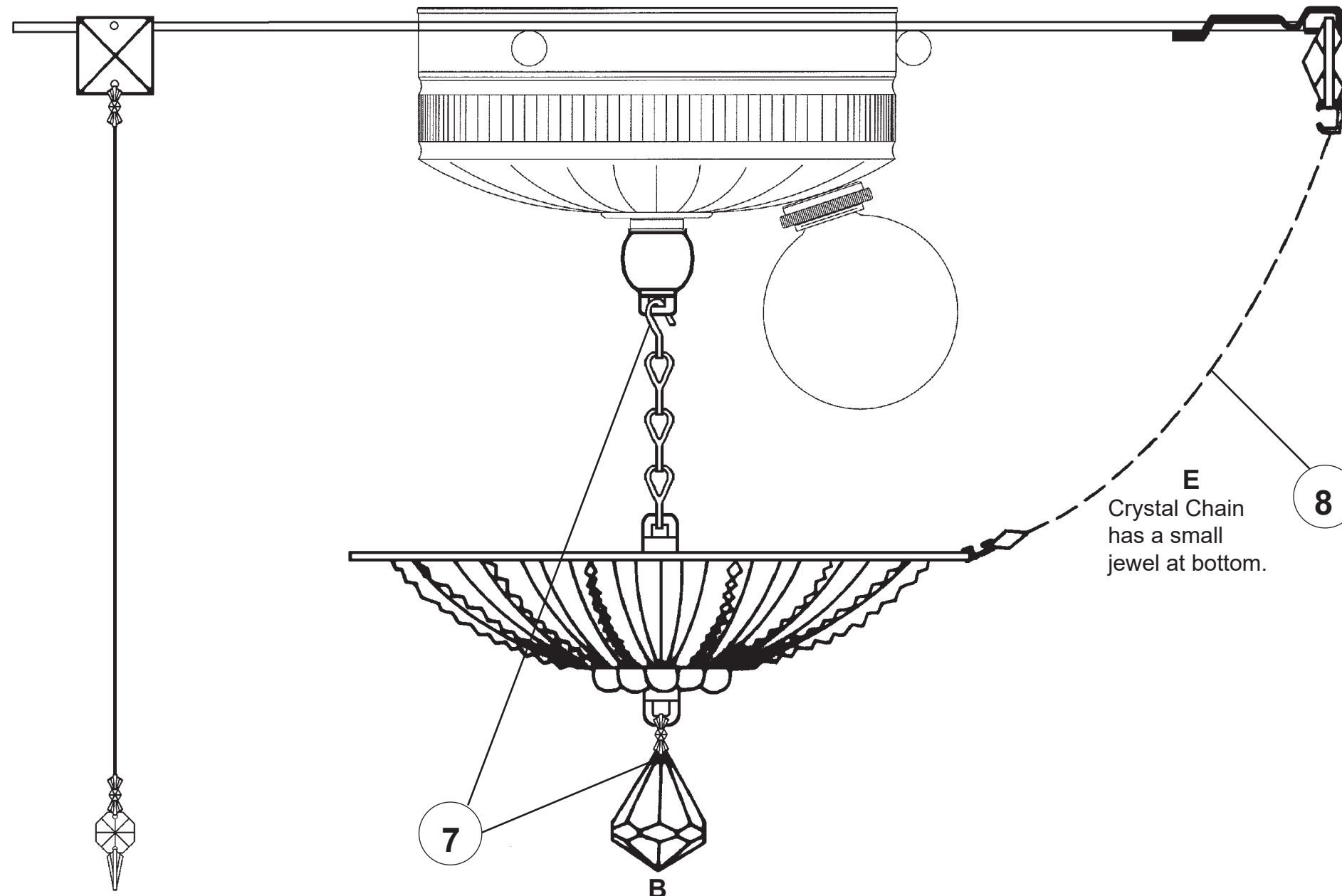

ILLUSTRATION 4

5 Assemble all crystal chains and pins provided. See "Crystal Chain Assembly" above. Set mirror plate on cardboard stand. Hook all Crystal Chains "E" into slots in the mirror plate so the metal accessories face outwards and the square jewel is on the upper end. See illustrations #1 - #3. NOTE: Allow ends with small jewels to hang loose.

6 Align holes in mirror plate with the balls on the frame, raise mirror plate over balls, then turn mirror clockwise until holes are halfway between balls. See illustration #4.



PETIT CRYSTAL DELUXE 5893-__ __R

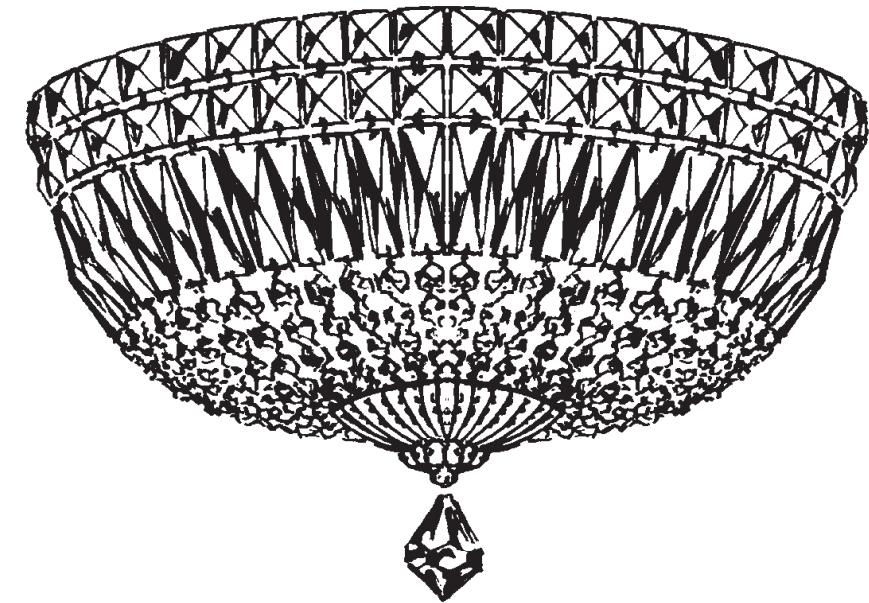











5 Lights
Diameter: 14"
Body Length: 8"
Hanging Weight: 7 lbs.

THIS DESIGN IS THE PROPRIETARY
TRADE DRESS/TRADEMARK OF
W SCHONBEK LLC.

 **SCHONBEK** | 1870

 **SCHONBEK** | 1870

								
MAX 40 W	110-120 V							

All electrical components must be installed by a licensed electrician in accordance with the National Electric Code and the appropriate local electrical codes.

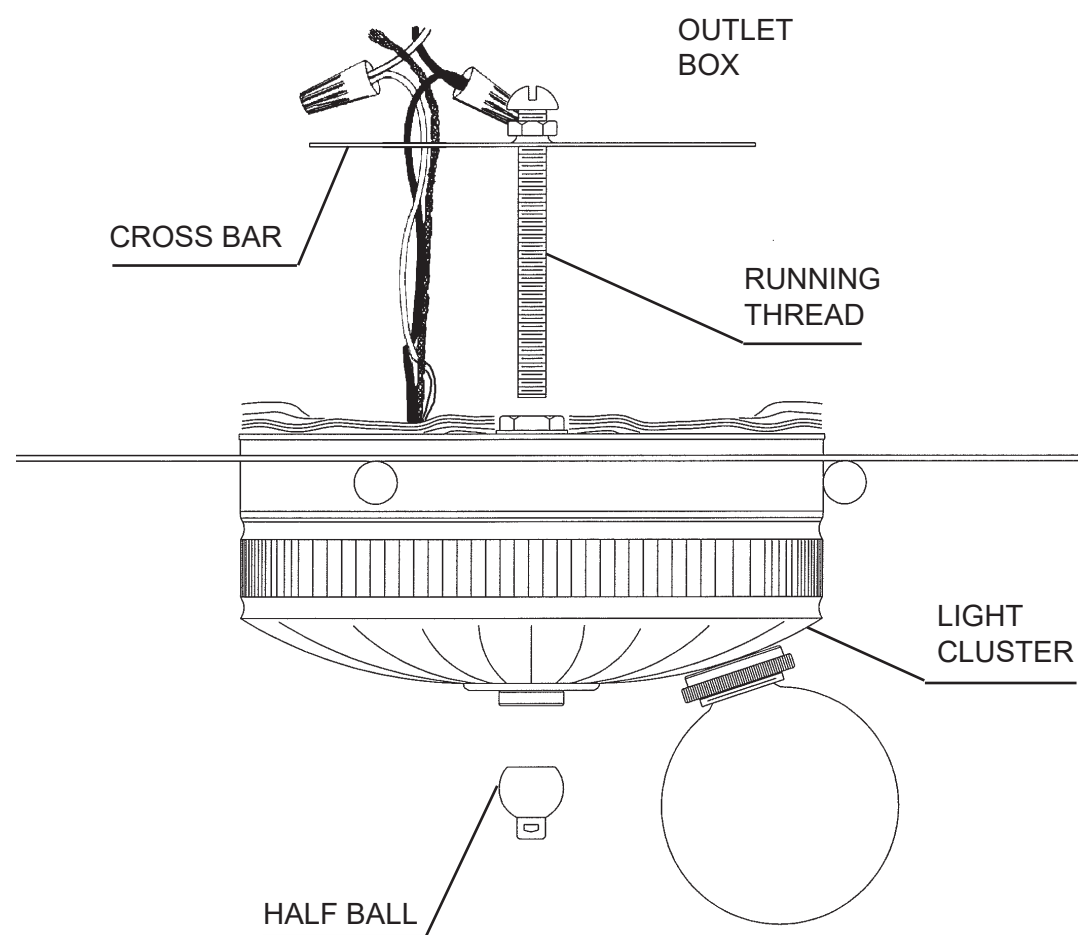

- 1** Remove crossbar from light cluster and attach to outlet box.
- 2** Feed stem wires through crossbar and attach to power wires in outlet box.
- 3** Place light cluster over thread attached to crossbar and secure with half ball.

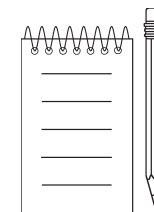

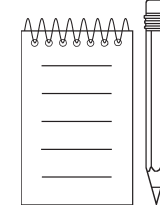
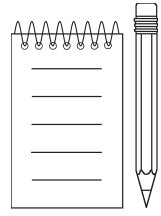

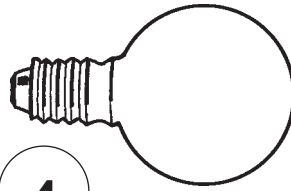

4

You will need 5 - G16-1/2
25 Watts Recommended
40 Watts Max
MIN 90°C SUPPLY
CONDUCTORS

Install bulbs and be sure
to test fixture **BEFORE**
trimming.

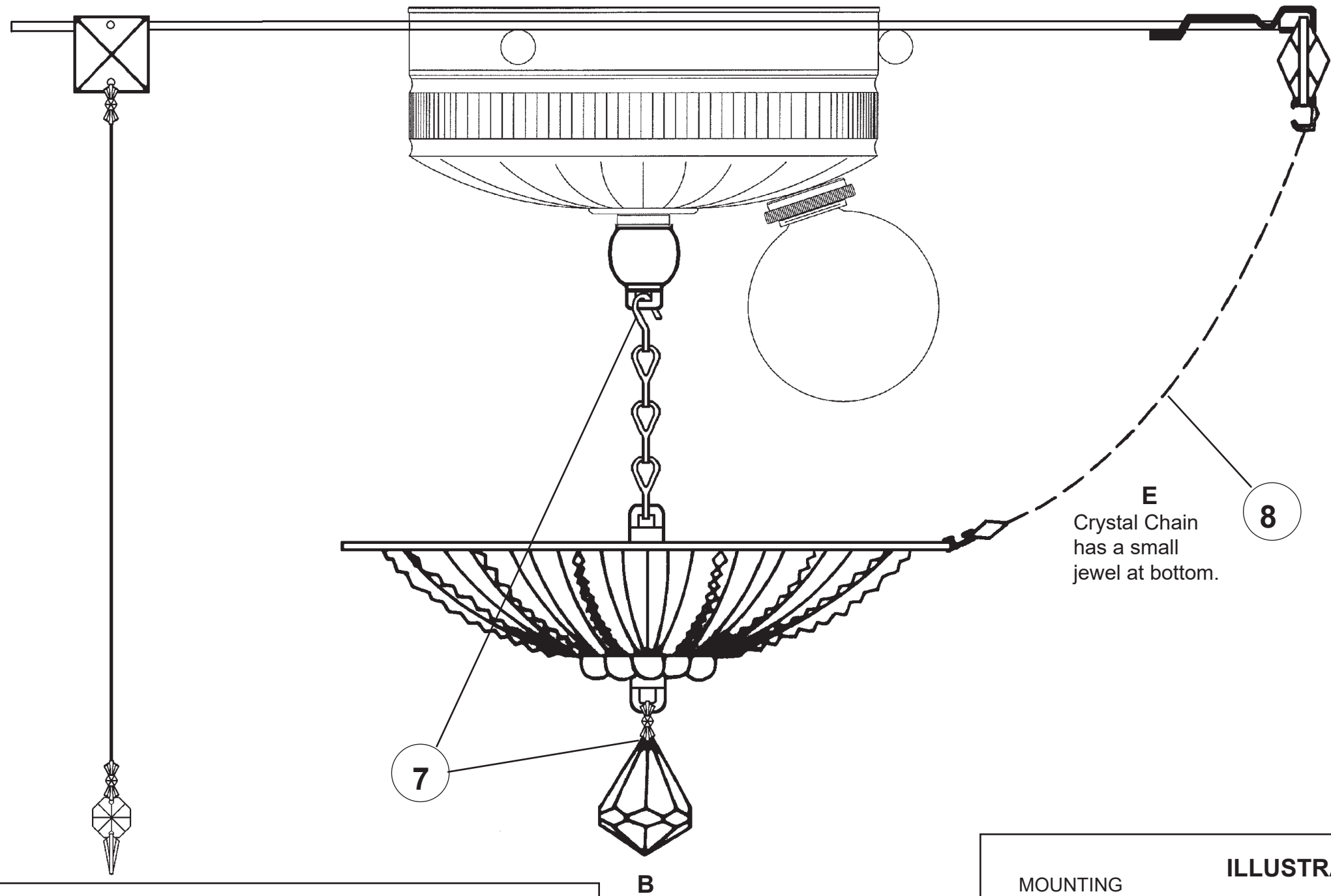

E
Crystal Chain
has a small
jewel at bottom.

8

7

B

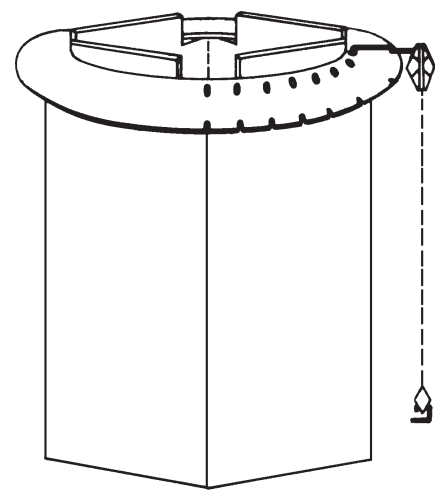

5 Set mirror plate on cardboard stand. Hook
all Crystal Chains "E" into slots in the mirror
plate so the metal accessories face outwards
and the square jewel is on the upper end. See
illustrations #1 - #3. NOTE: Allow ends with
small jewels to hang loose.

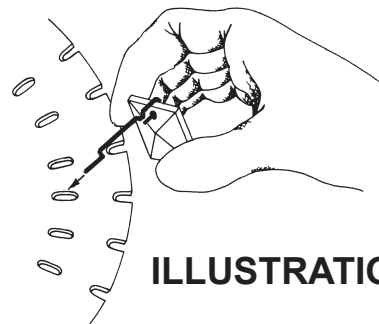

ILLUSTRATION 1

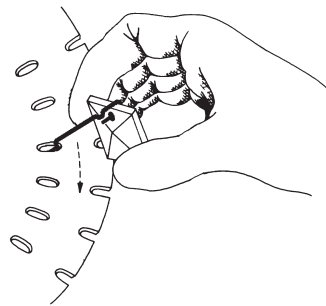

ILLUSTRATION 2

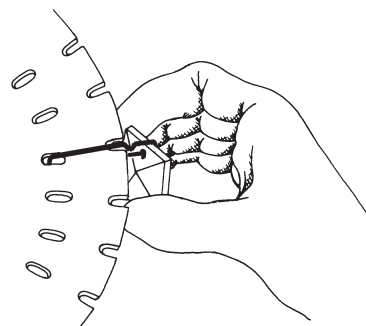

ILLUSTRATION 3

ILLUSTRATION 4

MOUNTING
POINTS

LIGHT
CLUSTER

MIRROR
PLATE

6 Align holes in mirror plate with the balls on
the light cluster, raise mirror plate over balls,
then turn mirror clockwise until holes are
halfway between balls. See illustration #4.

PETIT CRYSTAL DELUXE 5893-__ __S

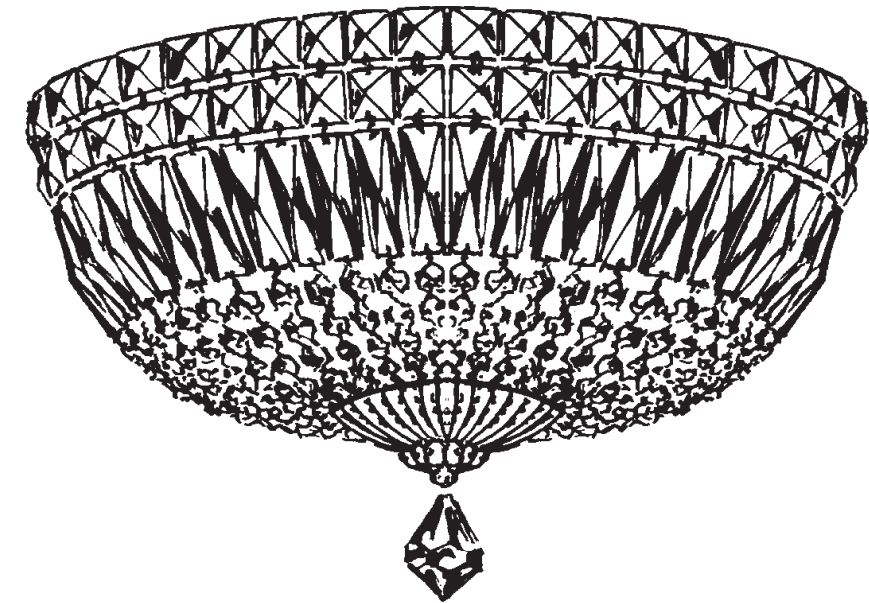











5 Lights
Diameter: 14"
Body Length: 8"
Hanging Weight: 7 lbs.

THIS DESIGN IS THE PROPRIETARY
TRADE DRESS/TRADEMARK OF
W SCHONBEK LLC.

 **SCHONBEK** | 1870

 **SCHONBEK** | 1870

									
MAX 40 W		110-120 V							

All electrical components must be installed by a licensed electrician in accordance with the National Electric Code and the appropriate local electrical codes.

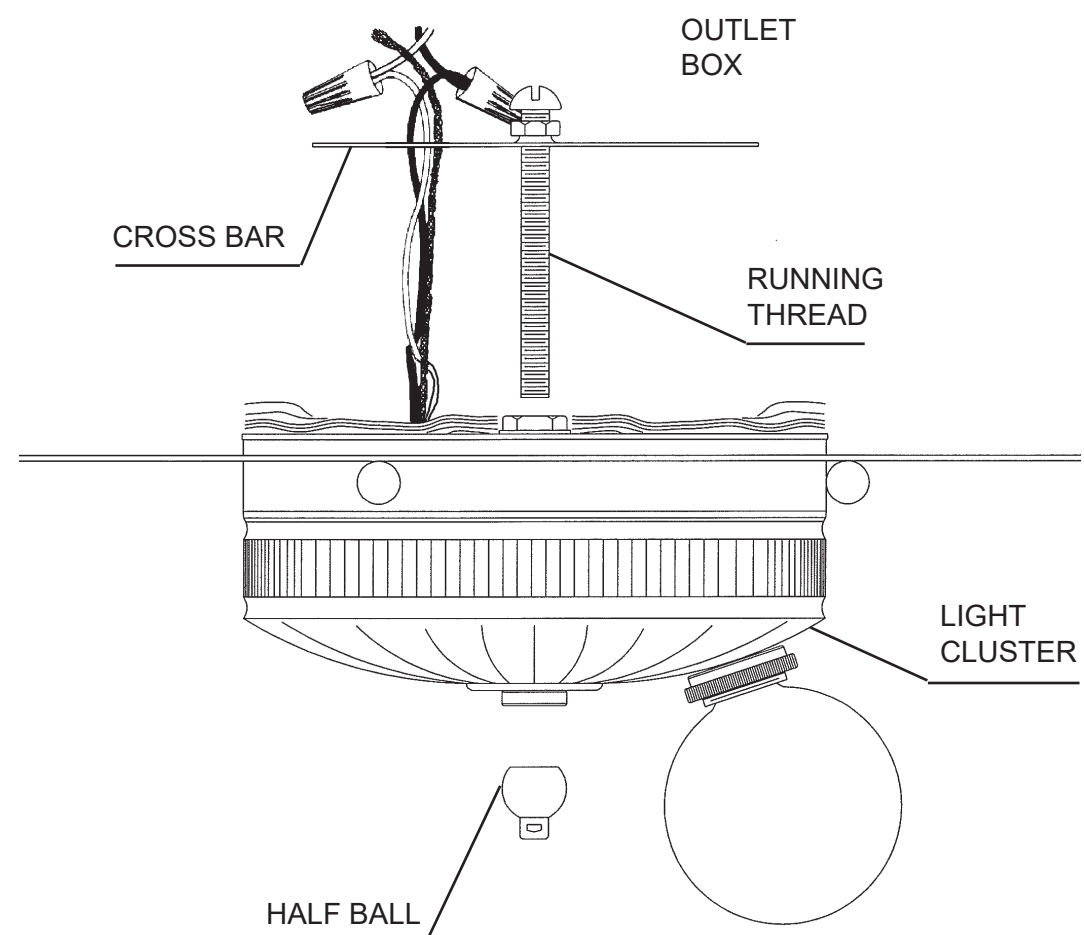

- 1** Remove crossbar from light cluster and attach to outlet box.
- 2** Feed stem wires through crossbar and attach to power wires in outlet box.
- 3** Place light cluster over thread attached to crossbar and secure with half ball.

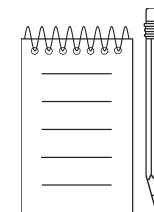



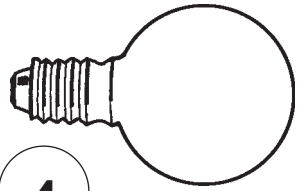

4

You will need 5 - G16-1/2
25 Watts Recommended
40 Watts Max
MIN 90°C SUPPLY
CONDUCTORS

Install bulbs and be sure
to test fixture **BEFORE**
trimming.

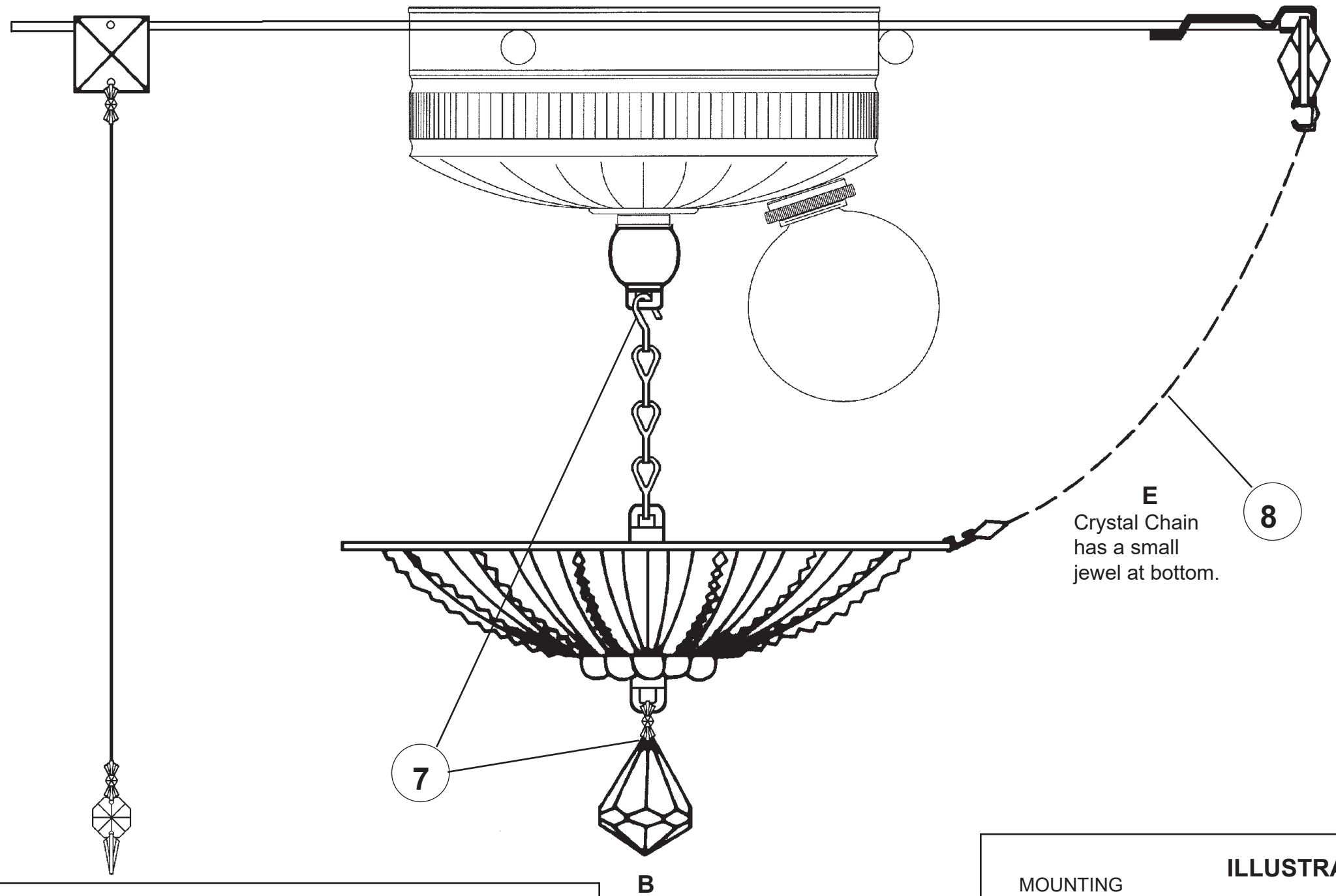

E
Crystal Chain
has a small
jewel at bottom.

8

7

B

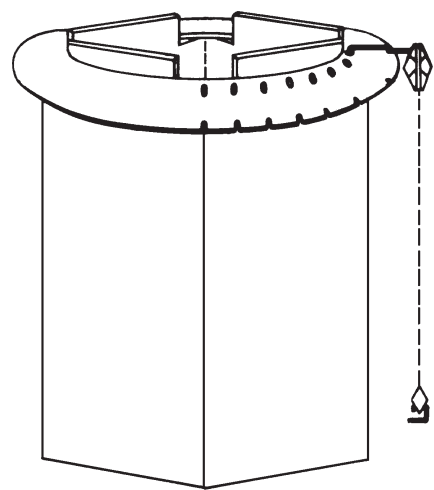

5 Set mirror plate on cardboard stand. Hook all Crystal Chains "E" into slots in the mirror plate so the metal accessories face outwards and the square jewel is on the upper end. See illustrations #1 - #3. NOTE: Allow ends with small jewels to hang loose.

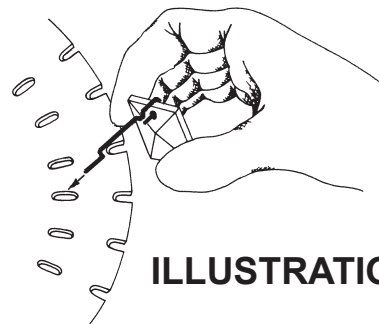

ILLUSTRATION 1



ILLUSTRATION 2

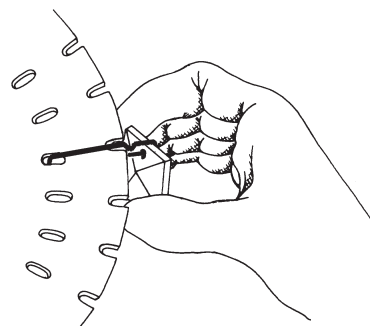

ILLUSTRATION 3

ILLUSTRATION 4

MOUNTING POINTS

LIGHT CLUSTER

MIRROR PLATE

6 Align holes in mirror plate with the balls on the light cluster, raise mirror plate over balls, then turn mirror clockwise until holes are halfway between balls. See illustration #4.