

PETIT CRYSTAL DELUXE 6600- ___ _O

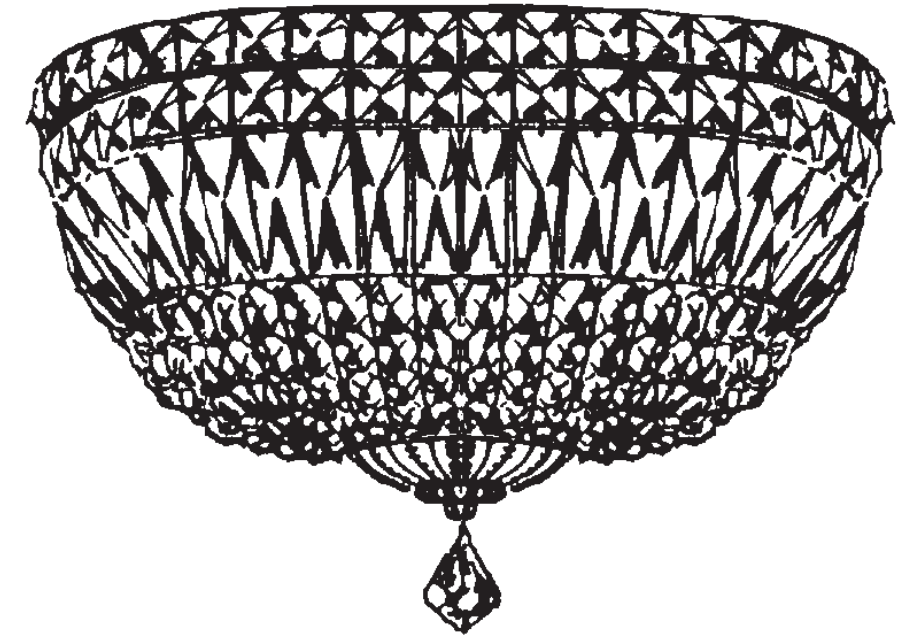











3 Lights
Diameter: 10"
Body Length: 7-1/2"
Extension: 5"
Hanging Weight: 4 lbs.

THIS DESIGN IS THE PROPRIETARY
TRADE DRESS/TRADEMARK OF
W SCHONBEK LLC.

 **SCHONBEK** | 1870

 **SCHONBEK** | 1870

								
MAX 40 W	110-120 V							

All electrical components must be installed by a licensed electrician in accordance with the National Electric Code and the appropriate local electrical codes.

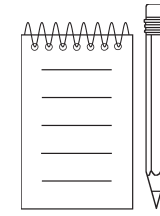
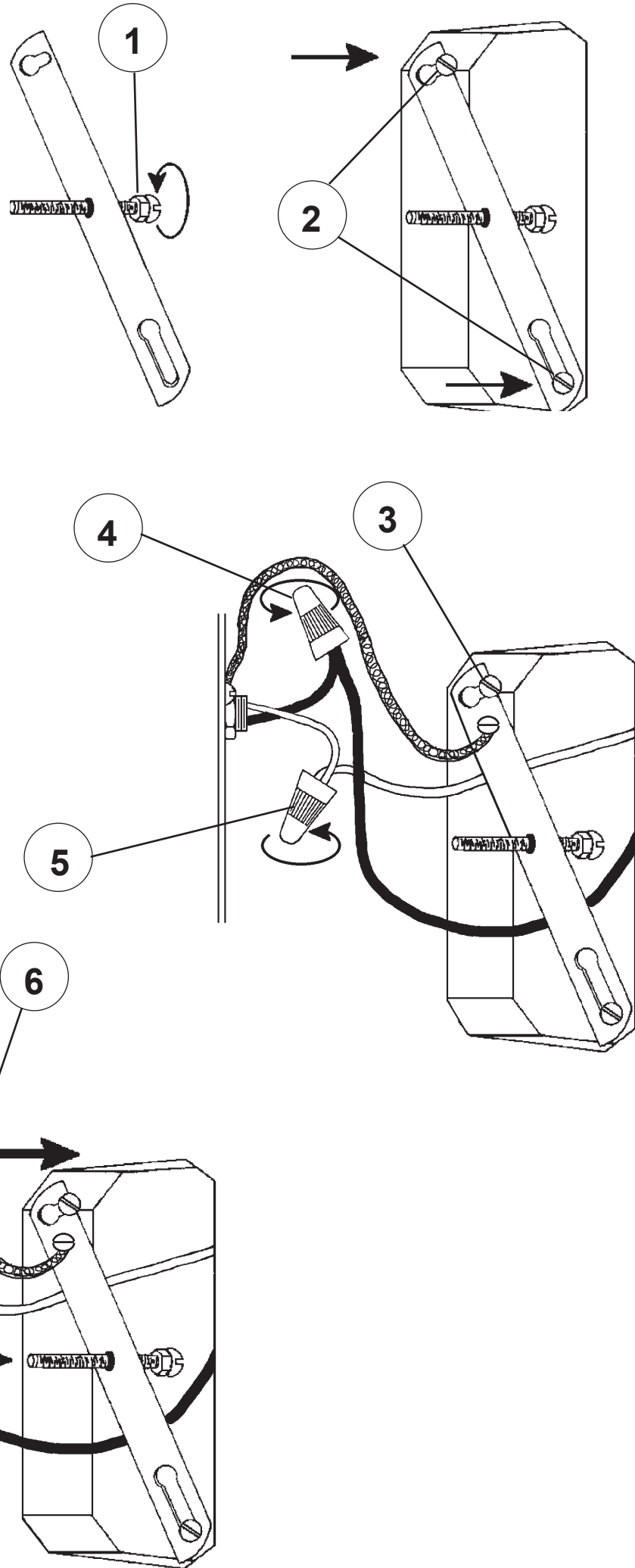



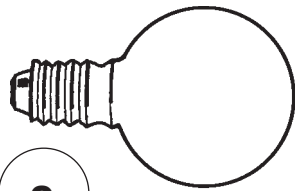

8

You will need 3 - G16-1/2
25 Watts Recommended
40 Watts Max

Install bulbs and be sure
to test fixture **BEFORE**
trimming.

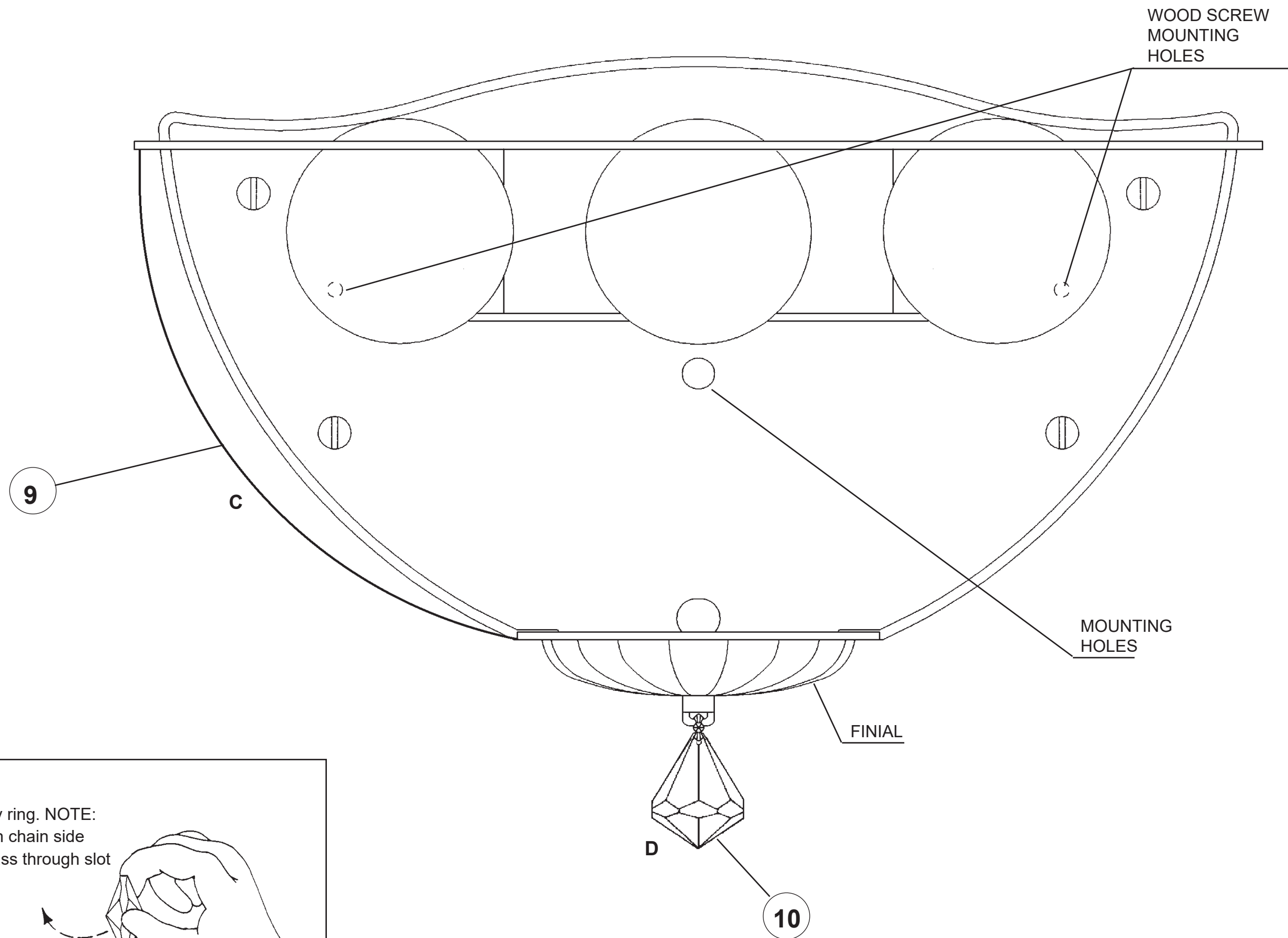

9 Hook Chains "C" into the gallery ring. NOTE:
Hold onto the square stone and turn chain side
ways, this will allow connector to pass through slot
in metal ring. Turn
square stone to face the
outside of the fixture
and lower it until it
seats itself in the
ring. Hook the other end
into the pin holes of the finial.

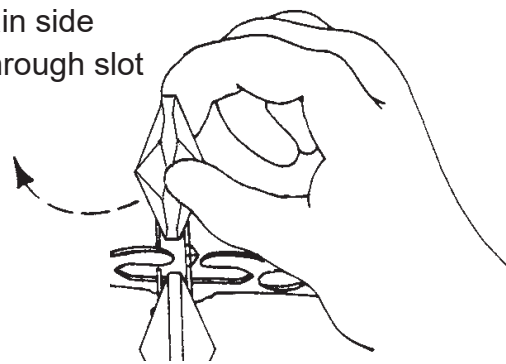

PETIT CRYSTAL DELUXE 6600- __ __ R

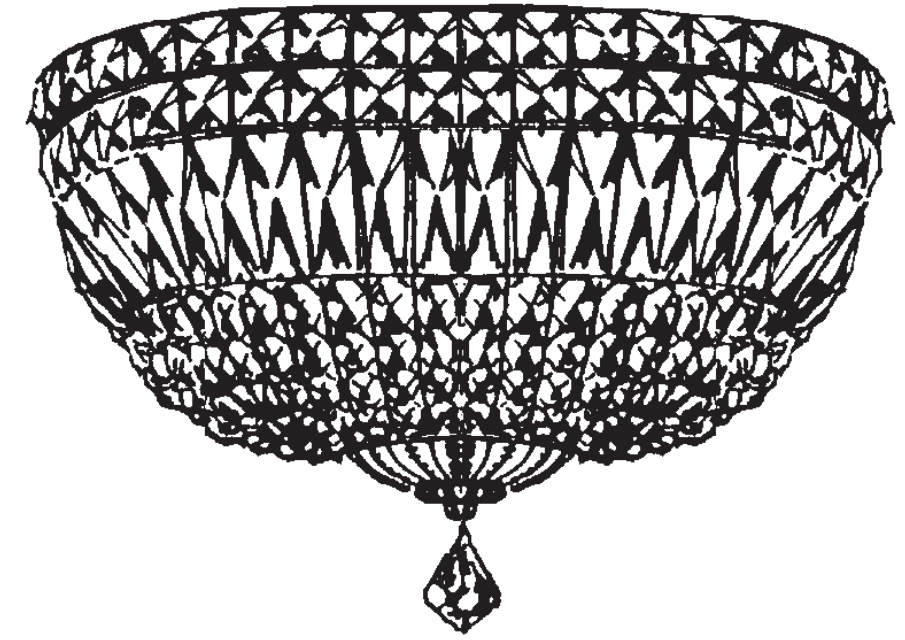











3 Lights
Diameter: 10"
Body Length: 7-1/2"
Extension: 5"
Hanging Weight: 4 lbs.

THIS DESIGN IS THE PROPRIETARY
TRADE DRESS/TRADEMARK OF
W SCHONBEK LLC.

 **SCHONBEK** | 1870

 **SCHONBEK** | 1870

								
MAX 40 W	110-120 V							

All electrical components must be installed by a licensed electrician in accordance with the National Electric Code and the appropriate local electrical codes.

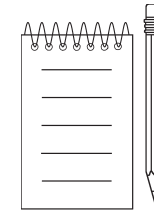
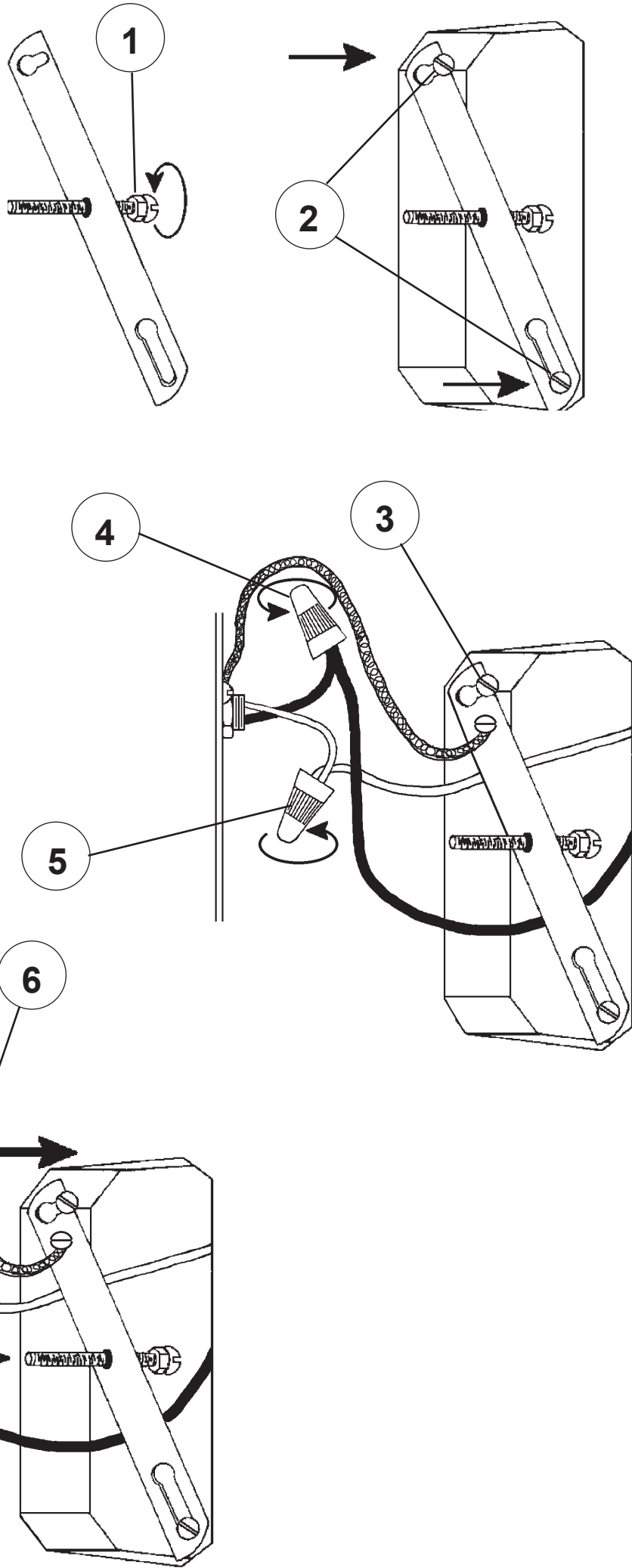

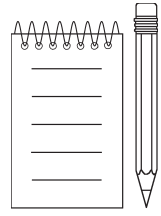

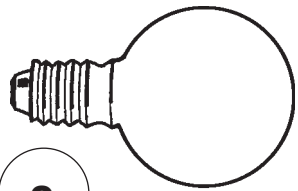

8

You will need 3 - G16-1/2
25 Watts Recommended
40 Watts Max

Install bulbs and be sure
to test fixture **BEFORE**
trimming.

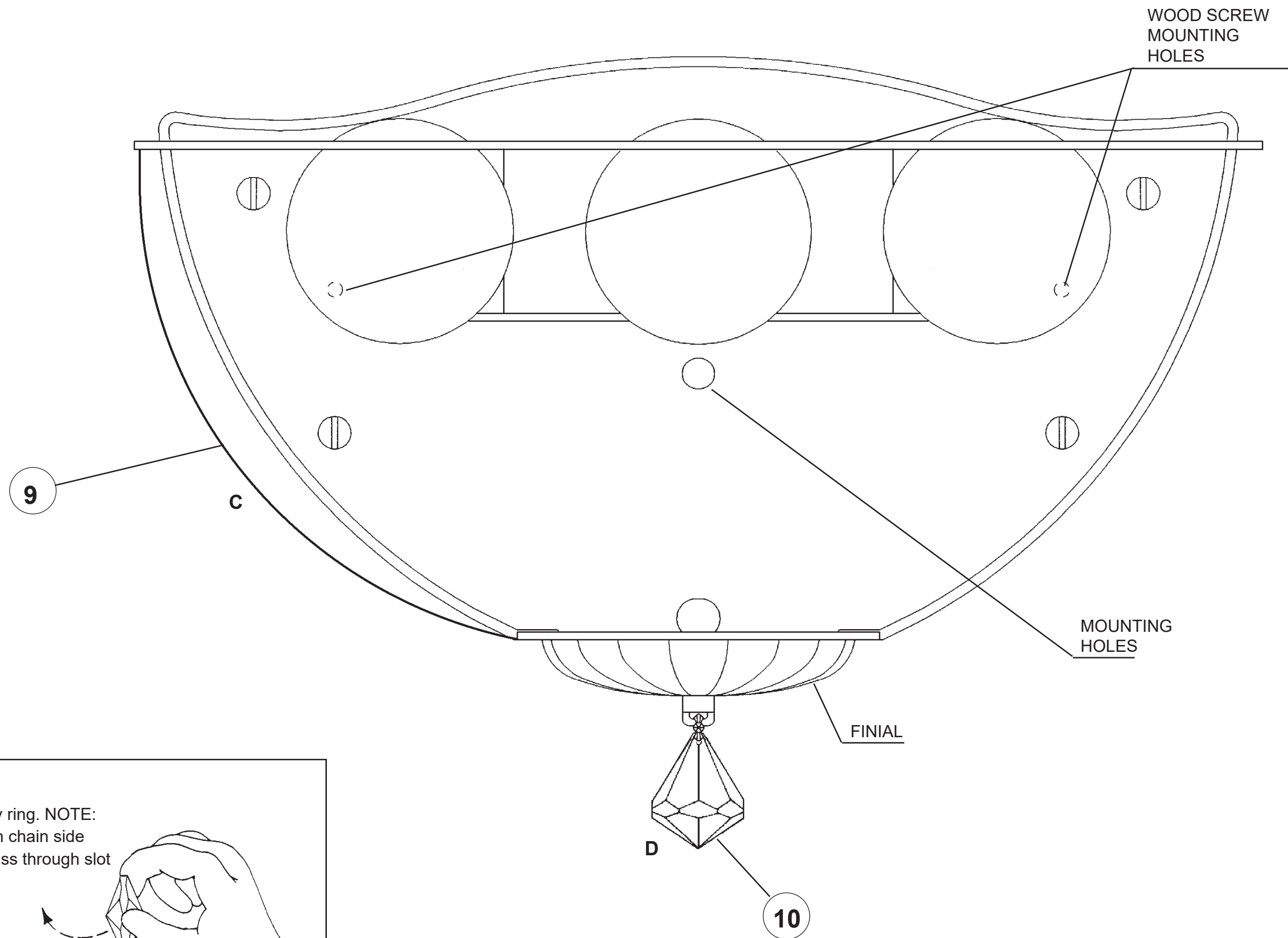

9 Hook Chains "C" into the gallery ring. NOTE: Hold onto the square stone and turn chain side ways, this will allow connector to pass through slot in metal ring. Turn square stone to face the outside of the fixture and lower it until it seats itself in the ring. Hook the other end into the pin holes of the finial.

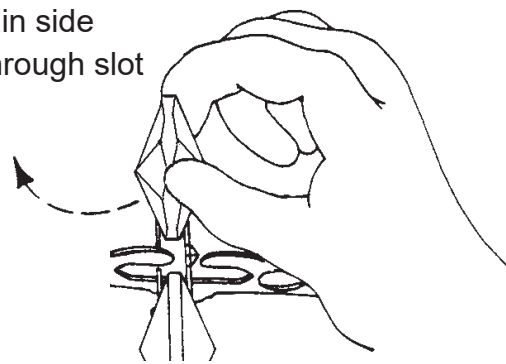

PETIT CRYSTAL DELUXE 6600- __ __ S

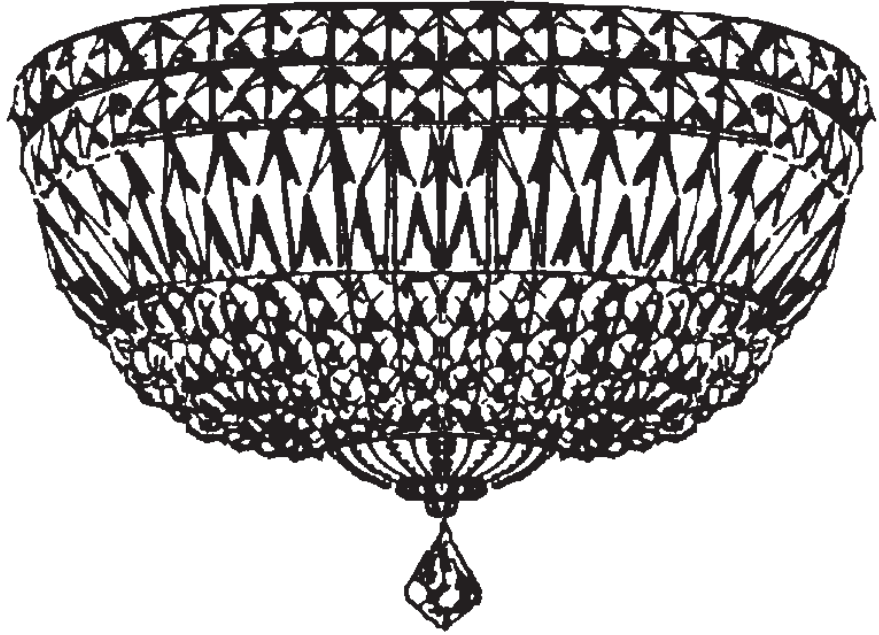











3 Lights
Diameter: 10"
Body Length: 7-1/2"
Extension: 5"
Hanging Weight: 4 lbs.

THIS DESIGN IS THE PROPRIETARY
TRADE DRESS/TRADEMARK OF
W SCHONBEK LLC.

 **SCHONBEK** | 1870

 **SCHONBEK** | 1870

								
MAX 40 W		110-120 V						

All electrical components must be installed by a licensed electrician in accordance with the National Electric Code and the appropriate local electrical codes.

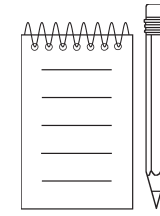
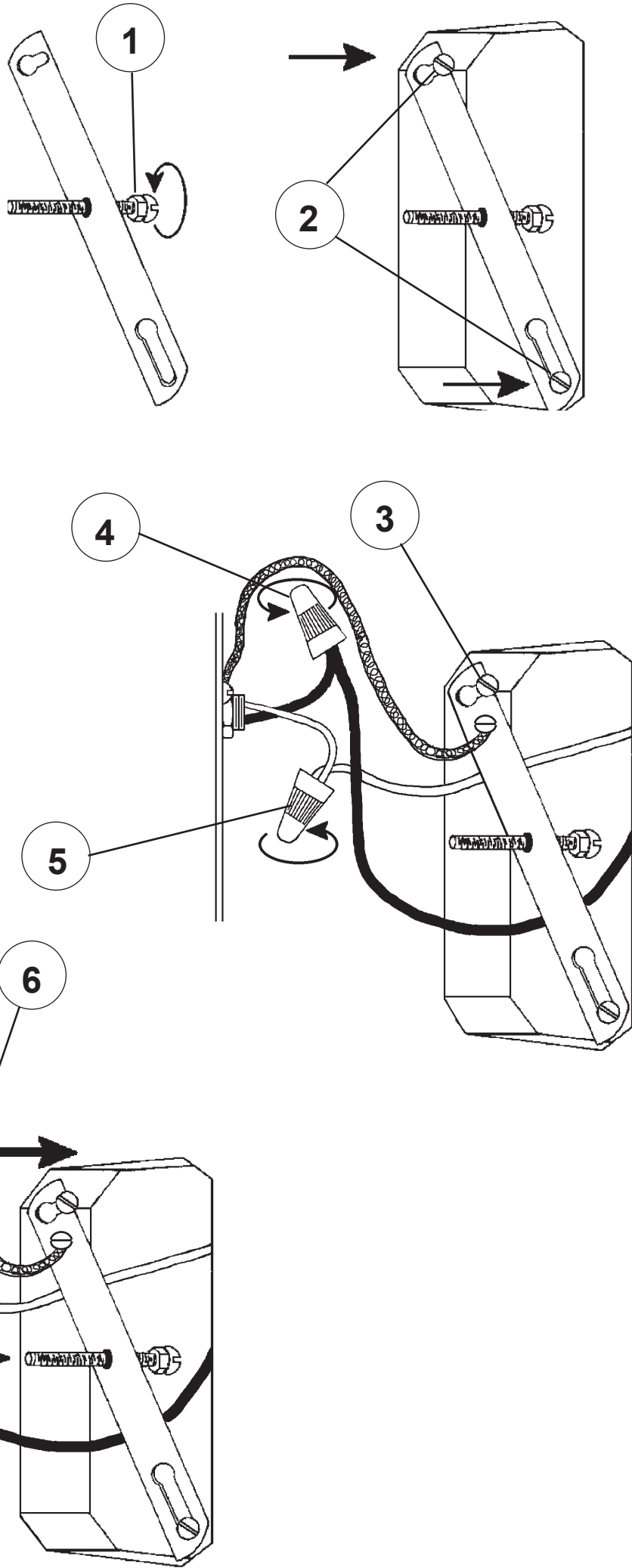



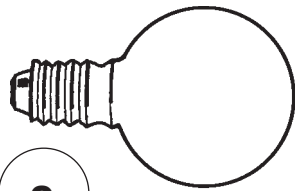

8

You will need 3 - G16-1/2
25 Watts Recommended
40 Watts Max

Install bulbs and be sure
to test fixture **BEFORE**
trimming.

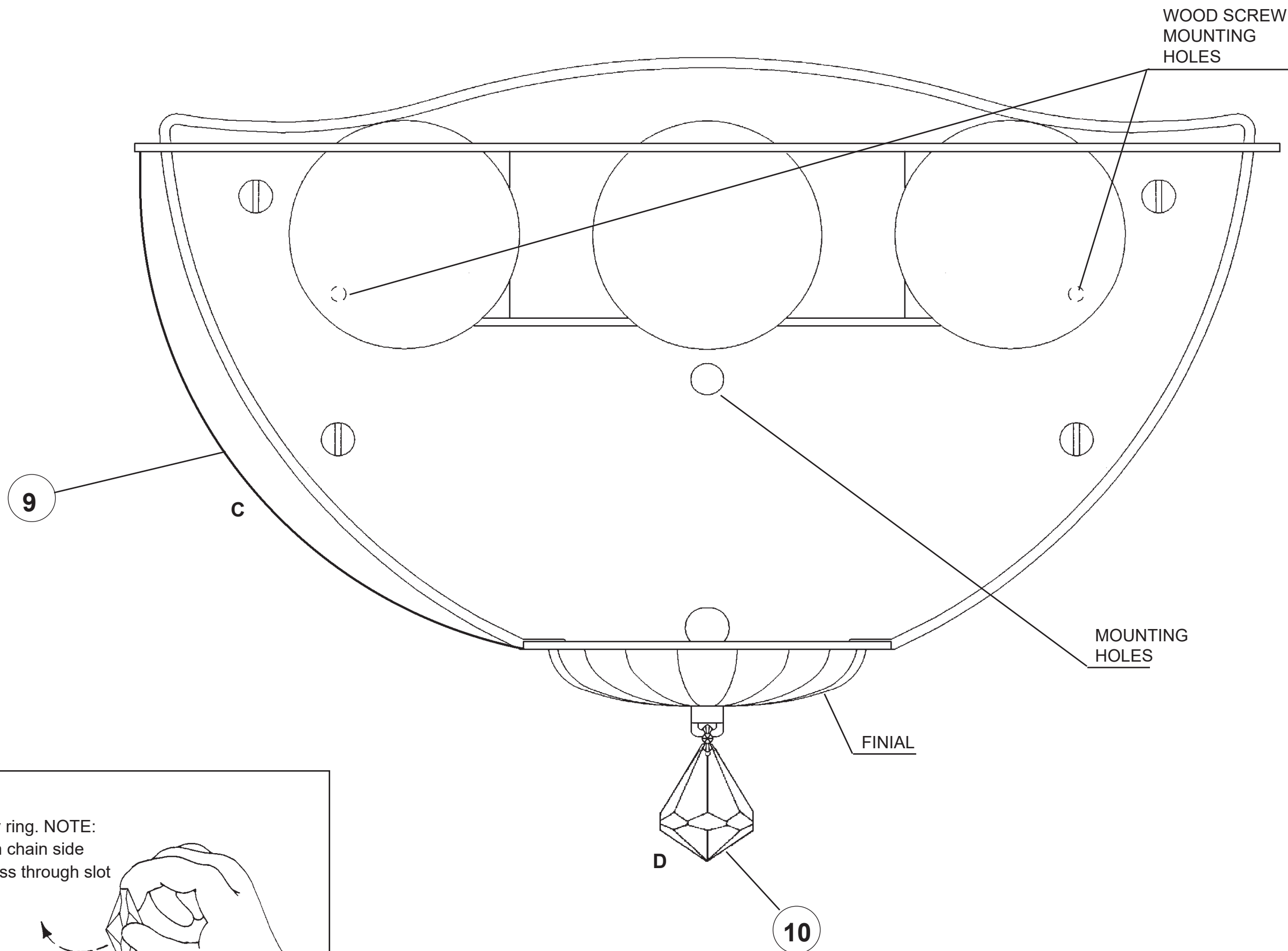

9 Hook Chains "C" into the gallery ring. NOTE: Hold onto the square stone and turn chain side ways, this will allow connector to pass through slot in metal ring. Turn square stone to face the outside of the fixture and lower it until it seats itself in the ring. Hook the other end into the pin holes of the finial.

