

OLDE WORLD 6805- \_\_ \_\_ H

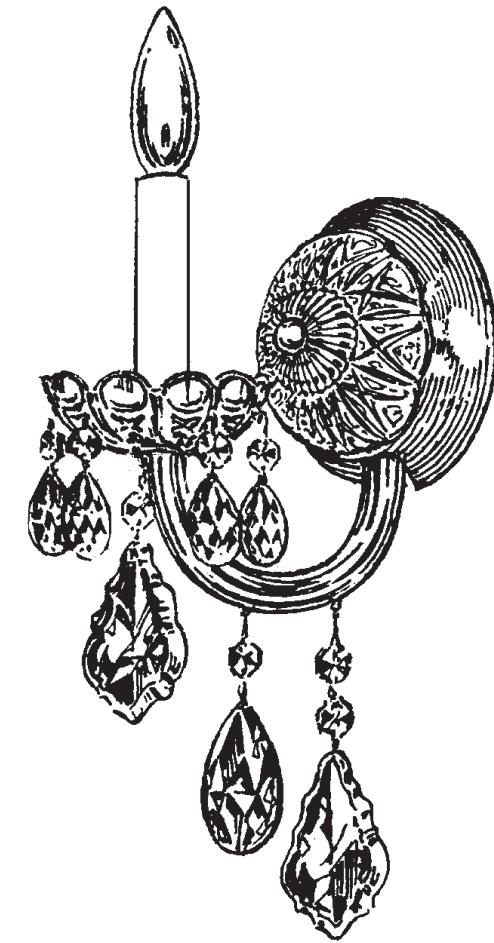











1 Light  
Diameter: 5"  
Body Length: 15"  
Extension: 7-1/2"  
Hanging Weight: 2 lbs.

**T**HIS DESIGN IS THE PROPRIETARY  
TRADE DRESS/TRADEMARK OF  
W SCHONBEK LLC.

 **SCHONBEK** | 1870

 **SCHONBEK** | 1870

								
MAX <b>60</b> W	110-120 V							

All electrical components must be installed by a licensed electrician in accordance with the National Electric Code and the appropriate local electrical codes.

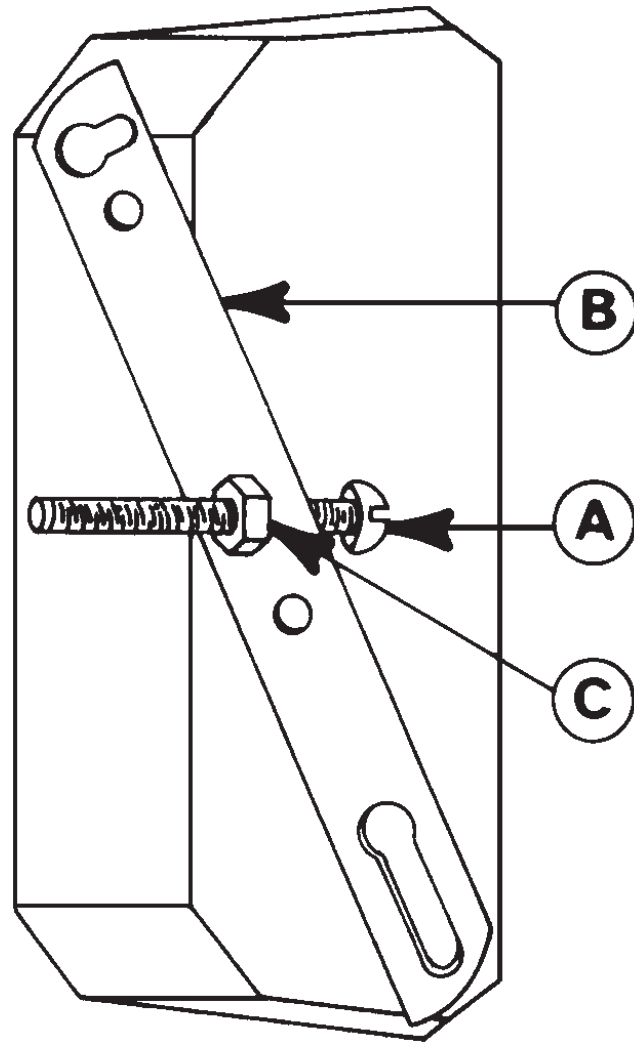

**1 MAKE SURE THAT POWER TO THE OUTLET BOX IS DISCONNECTED!!**

**2** Thread long screw "A" through crossbar "B" and attach crossbar to outlet box using 2 screws round head 8-32 x 1" (not supplied with wall bracket.)

**3** Test fit wall bracket by guiding it over screw "A". Adjust screw "A" so that it extends approximately 1/4" through wall bracket. Remove wall bracket. Thread nut "C" onto screw and tighten it against crossbar. (NOTE: In some installations, due to space, nut "C" might have to go on the other side of the crossbar.)

**4** Turn arm to line up hole in arm with dimple in plate. Tighten lock washer and nut to secure arm in place.

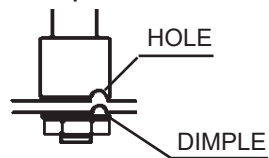

**5** Connect the wires of the wall bracket to the power wires of the outlet box, guide wall bracket over screw "A" and secure with threaded half ball supplied. NOTE: Fixture MUST be grounded.

**6** Install bobec(s) and screw bulb(s) into all socket(s). Test power to insure proper wiring before hanging trim from fixture.

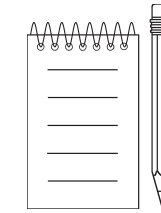

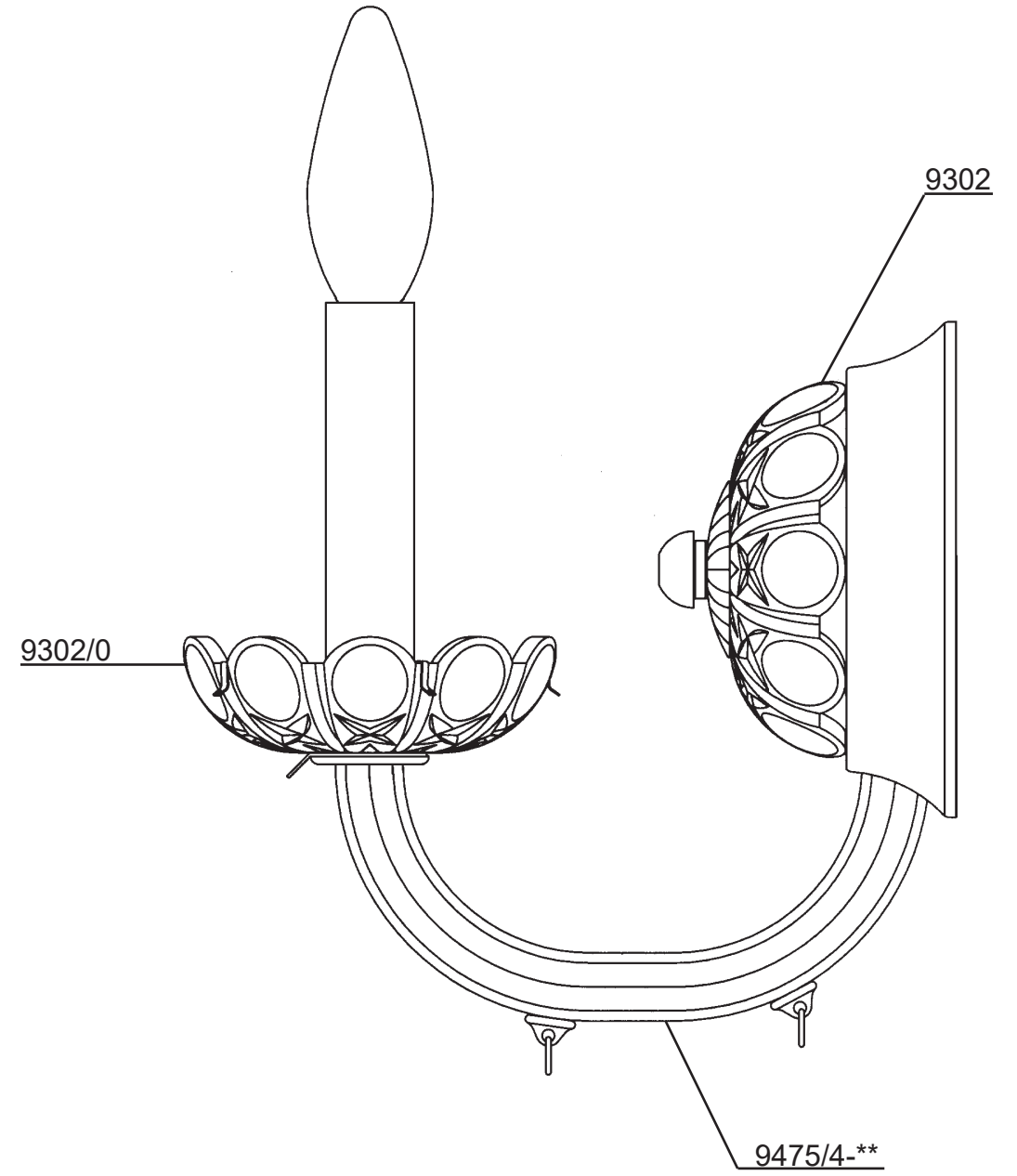
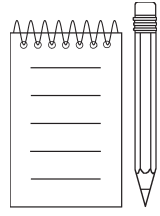



7

You will need 1 - B10  
25 Watts Recommended  
60 Watts Max

**Install bulbs and be sure  
to test fixture BEFORE  
trimming.**

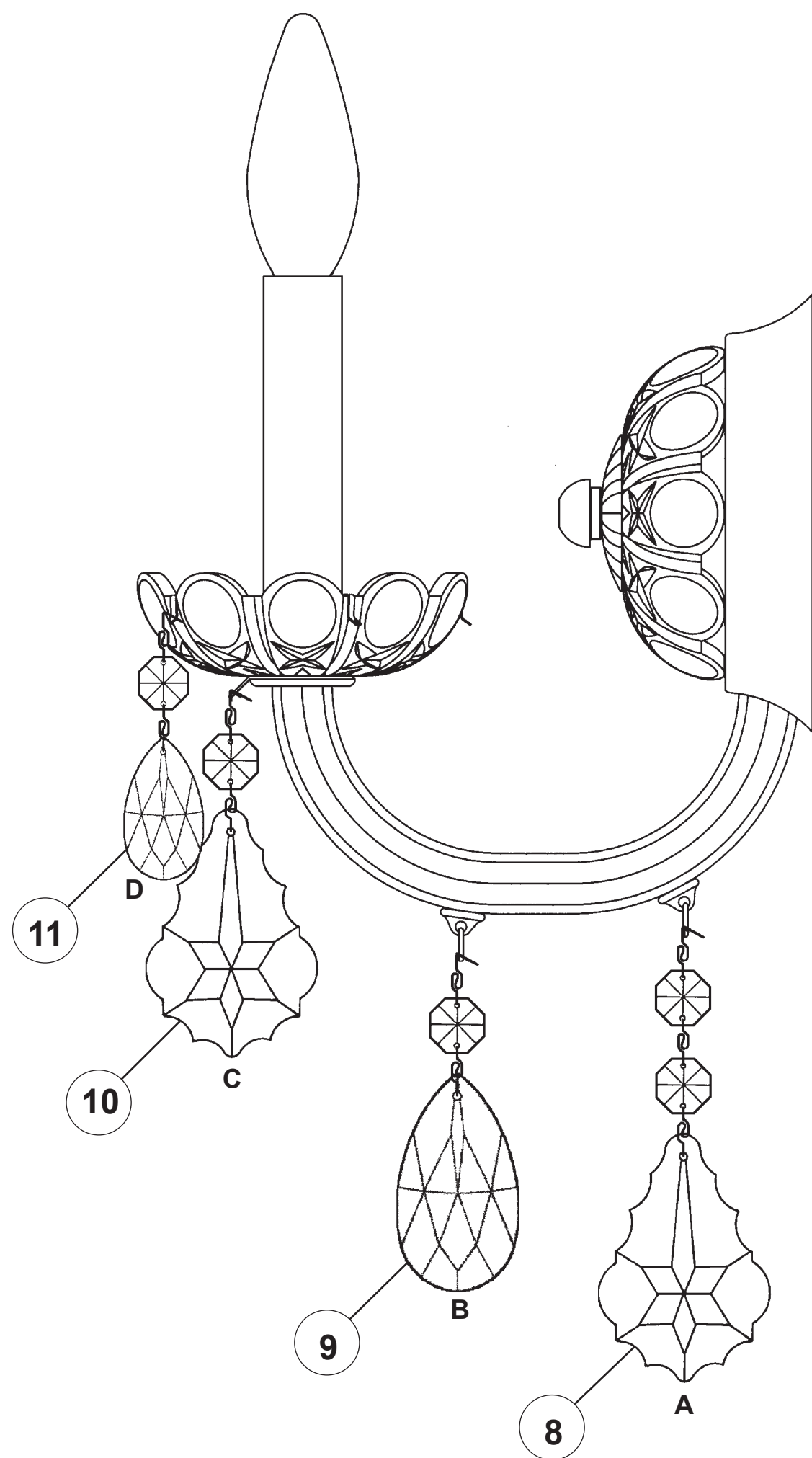

OLDE WORLD 6805- \_\_ \_\_ R

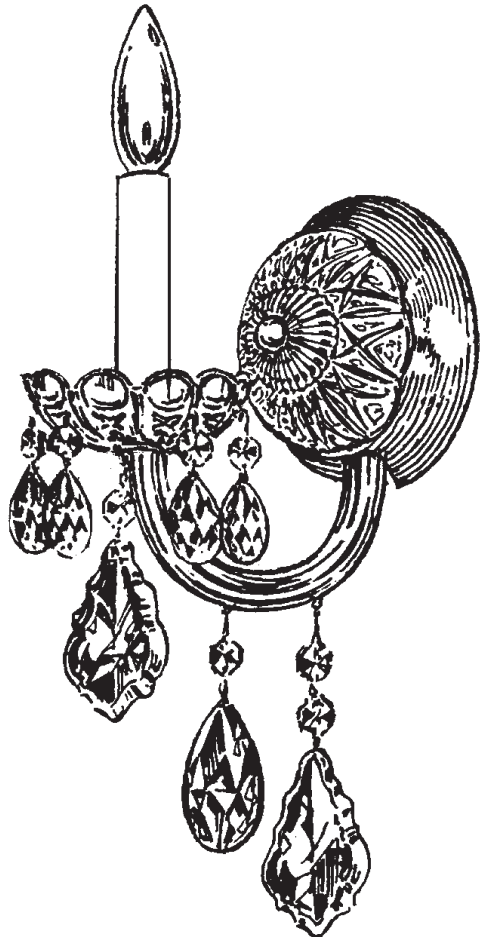











1 Light  
Diameter: 5"  
Body Length: 15"  
Extension: 7-1/2"  
Hanging Weight: 2 lbs.

**T**HIS DESIGN IS THE PROPRIETARY  
TRADE DRESS/TRADEMARK OF  
W SCHONBEK LLC.

 **SCHONBEK** | 1870

 **SCHONBEK** | 1870

								
MAX <b>60</b> W		110-120 V						

All electrical components must be installed by a licensed electrician in accordance with the National Electric Code and the appropriate local electrical codes.

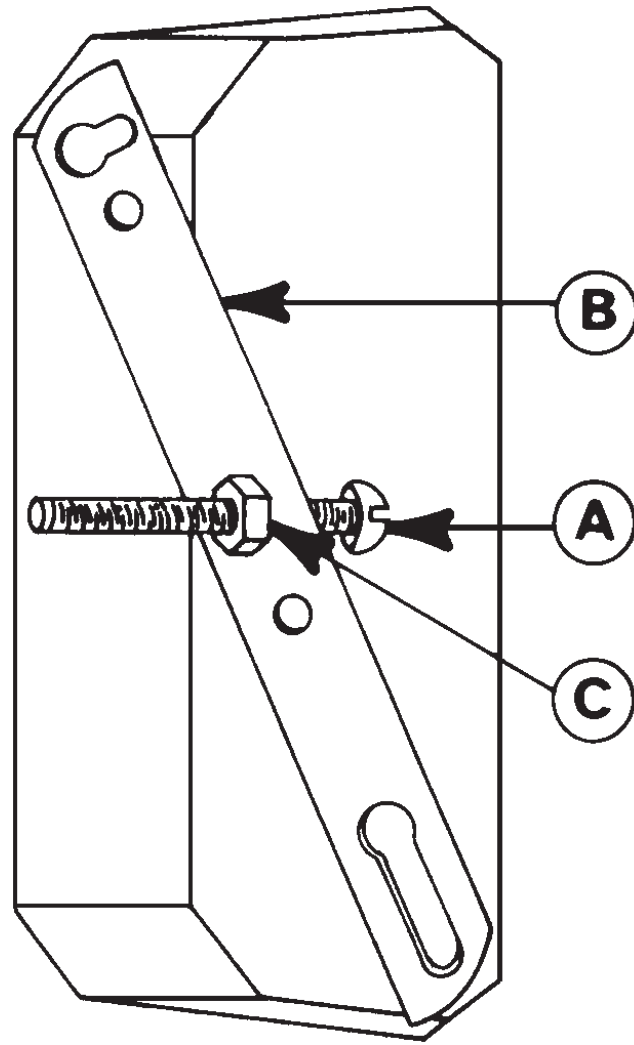

**1 MAKE SURE THAT POWER TO THE OUTLET BOX IS DISCONNECTED!!**

**2** Thread long screw "A" through crossbar "B" and attach crossbar to outlet box using 2 screws round head 8-32 x 1" (not supplied with wall bracket.)

**3** Test fit wall bracket by guiding it over screw "A". Adjust screw "A" so that it extends approximately 1/4" through wall bracket. Remove wall bracket. Thread nut "C" onto screw and tighten it against crossbar. (NOTE: In some installations, due to space, nut "C" might have to go on the other side of the crossbar.)

**4** Turn arm to line up hole in arm with dimple in plate. Tighten lock washer and nut to secure arm in place.

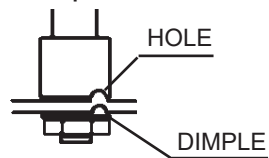

**5** Connect the wires of the wall bracket to the power wires of the outlet box, guide wall bracket over screw "A" and secure with threaded half ball supplied. NOTE: Fixture MUST be grounded.

**6** Install bobec(s) and screw bulb(s) into all socket(s). Test power to insure proper wiring before hanging trim from fixture.

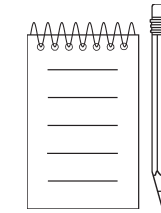

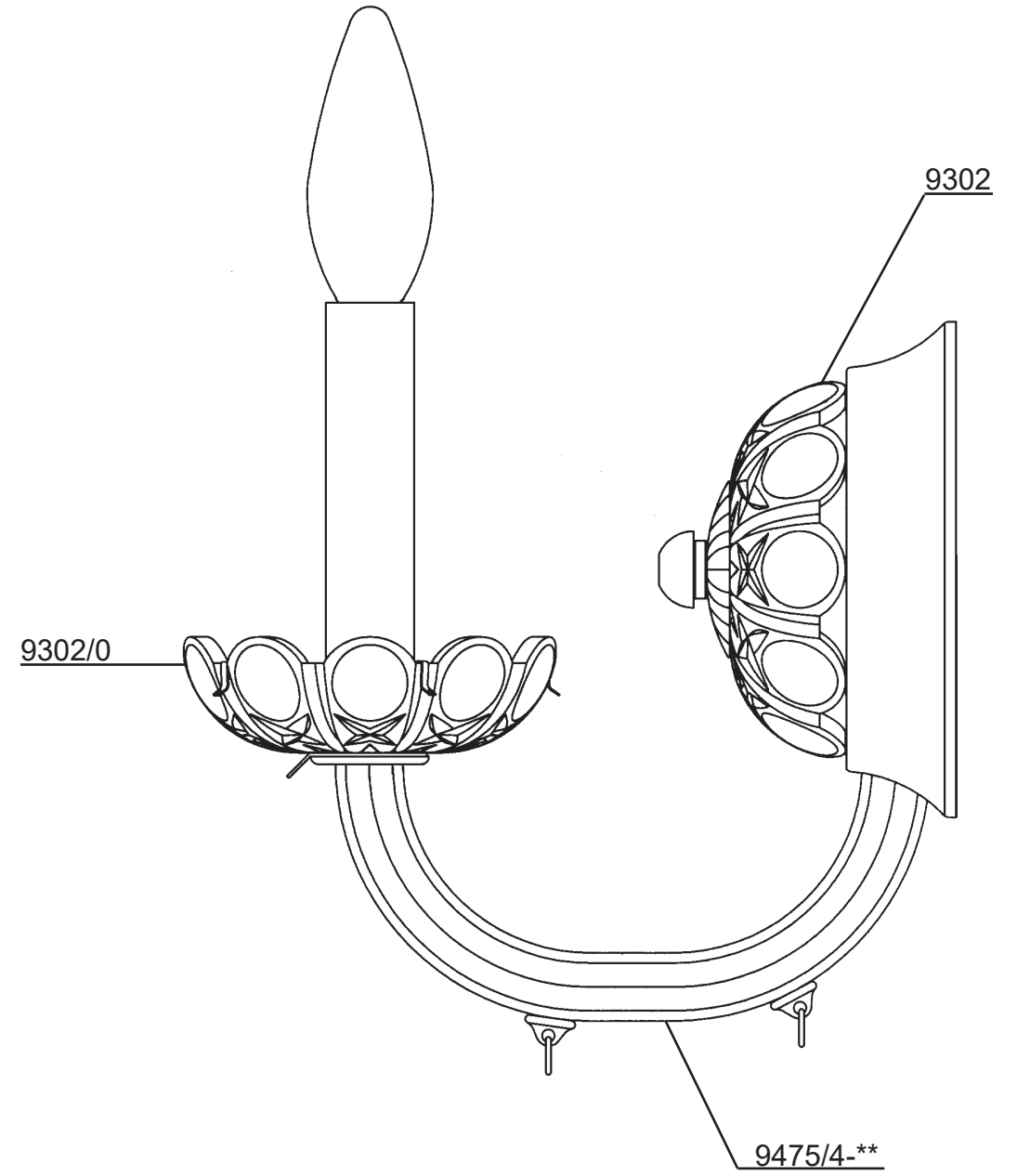
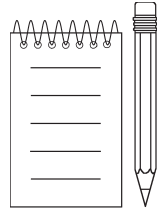



7

You will need 1 - B10  
25 Watts Recommended  
60 Watts Max

Install bulbs and be sure  
to test fixture **BEFORE**  
trimming.

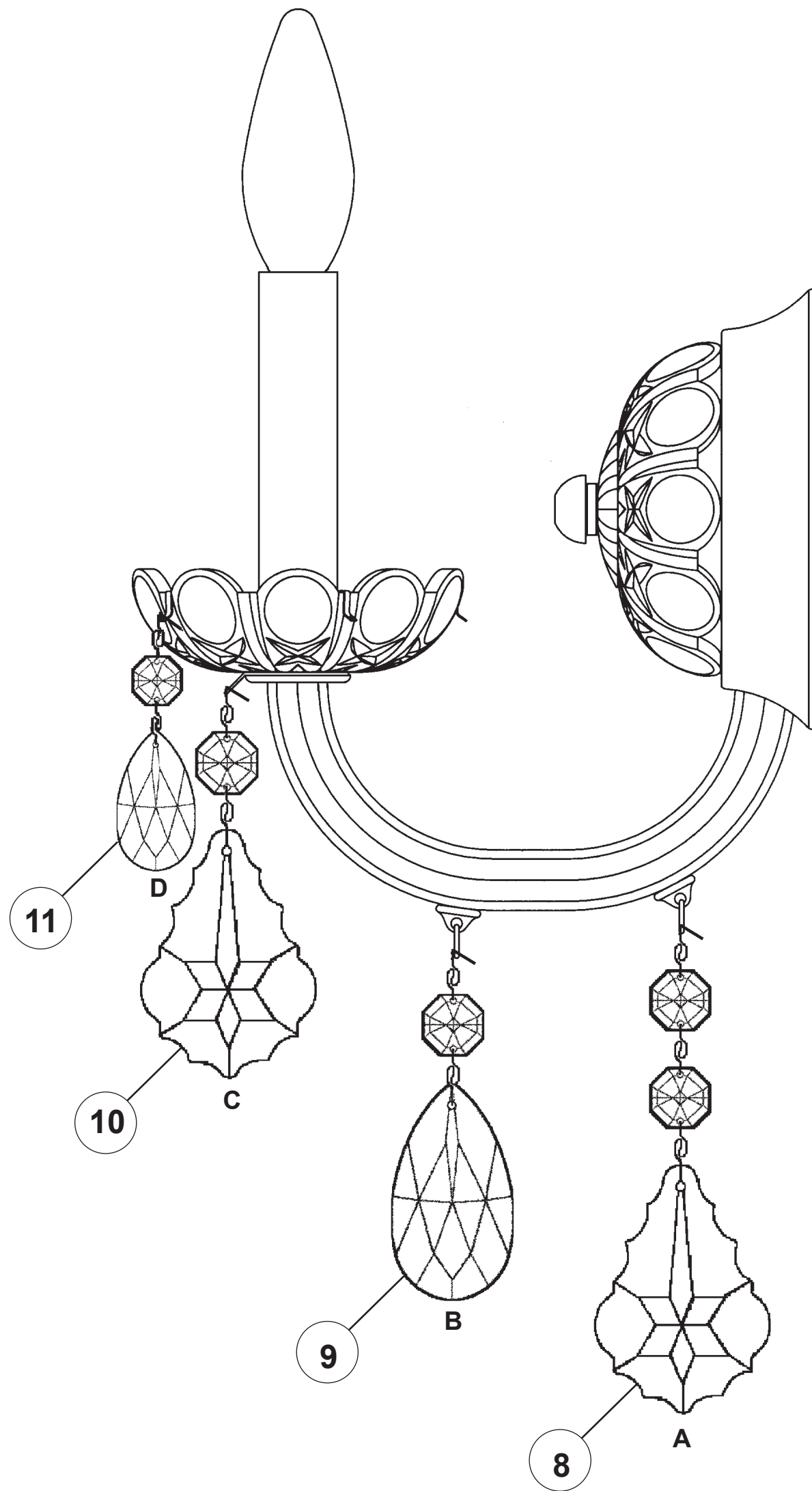



OLDE WORLD 6805- \_\_ \_\_ S

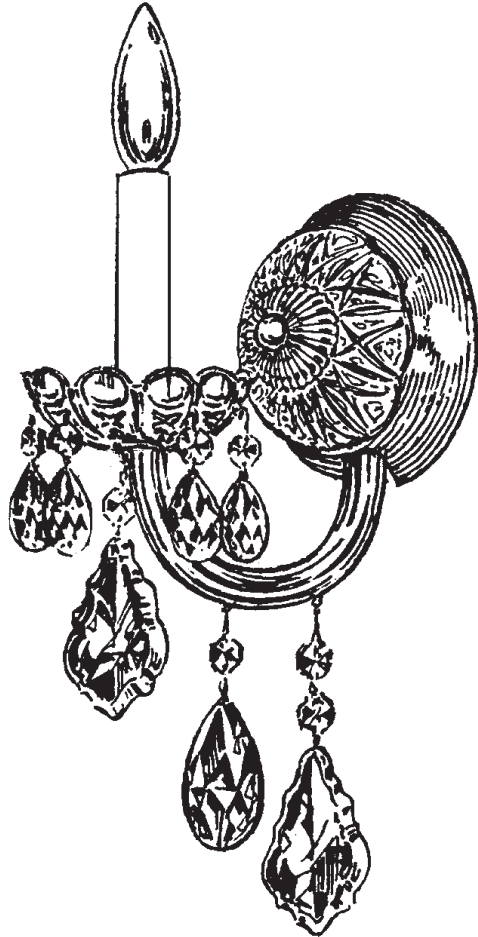











1 Light  
Diameter: 5"  
Body Length: 15"  
Extension: 7-1/2"  
Hanging Weight: 2 lbs.

**T**HIS DESIGN IS THE PROPRIETARY TRADE DRESS/TRADEMARK OF W SCHONBEK LLC.

 **SCHONBEK** | 1870

 **SCHONBEK** | 1870

								
MAX <b>60</b> W		110-120 V						

All electrical components must be installed by a licensed electrician in accordance with the National Electric Code and the appropriate local electrical codes.

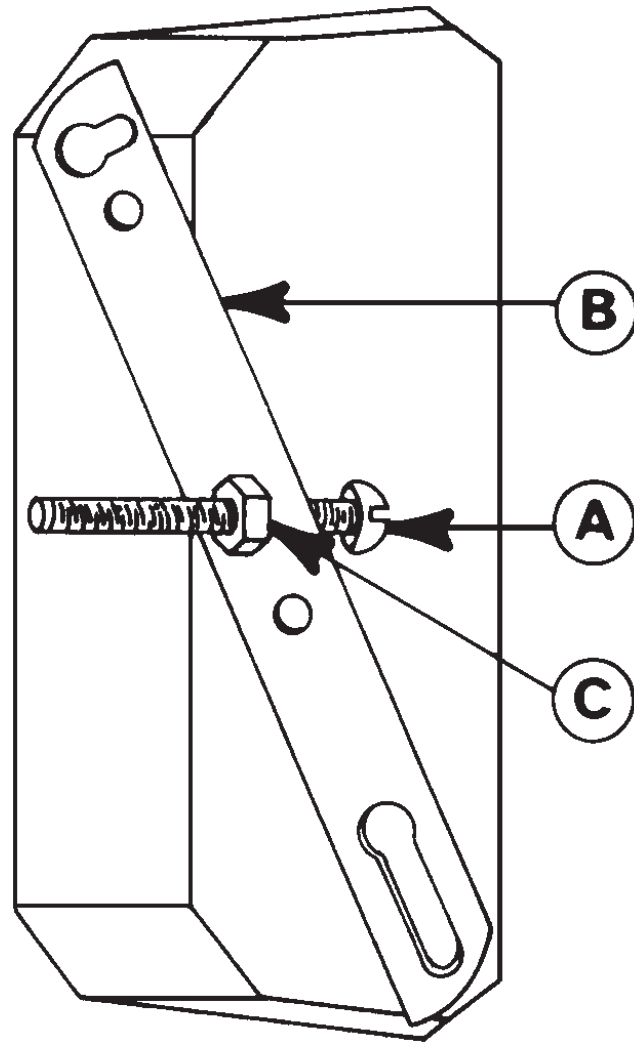

**1 MAKE SURE THAT POWER TO THE OUTLET BOX IS DISCONNECTED!!**

**2** Thread long screw "A" through crossbar "B" and attach crossbar to outlet box using 2 screws round head 8-32 x 1" (not supplied with wall bracket.)

**3** Test fit wall bracket by guiding it over screw "A". Adjust screw "A" so that it extends approximately 1/4" through wall bracket. Remove wall bracket. Thread nut "C" onto screw and tighten it against crossbar. (NOTE: In some installations, due to space, nut "C" might have to go on the other side of the crossbar.)

**4** Turn arm to line up hole in arm with dimple in plate. Tighten lock washer and nut to secure arm in place.

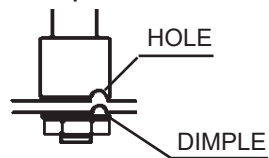

**5** Connect the wires of the wall bracket to the power wires of the outlet box, guide wall bracket over screw "A" and secure with threaded half ball supplied. NOTE: Fixture MUST be grounded.

**6** Install bobec(s) and screw bulb(s) into all socket(s). Test power to insure proper wiring before hanging trim from fixture.

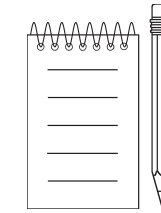

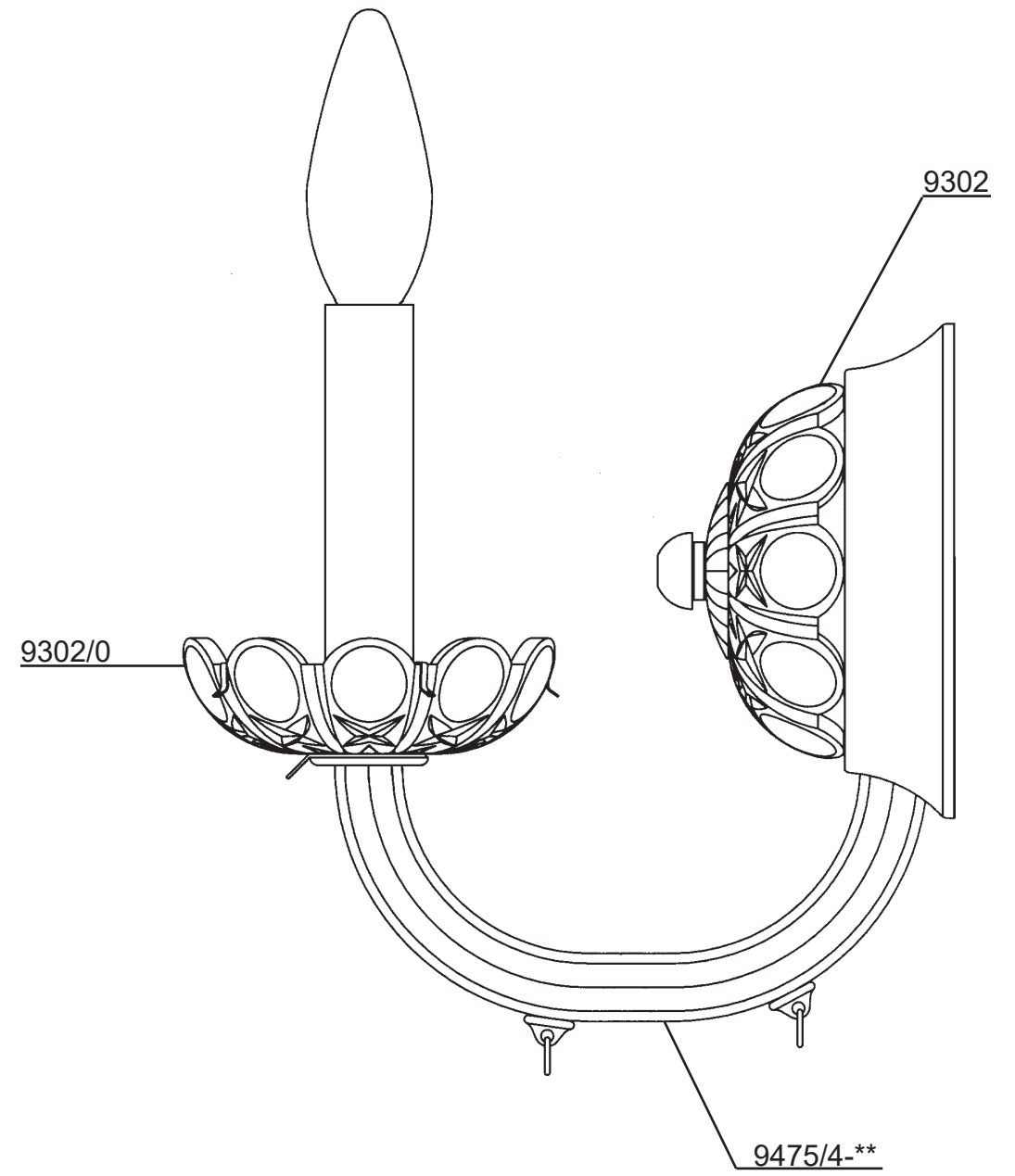
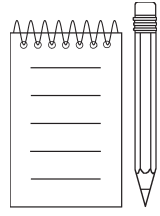



7

You will need 1 - B10  
25 Watts Recommended  
60 Watts Max

**Install bulbs and be sure  
to test fixture BEFORE  
trimming.**

