

 **SCHONBEK** | 1870

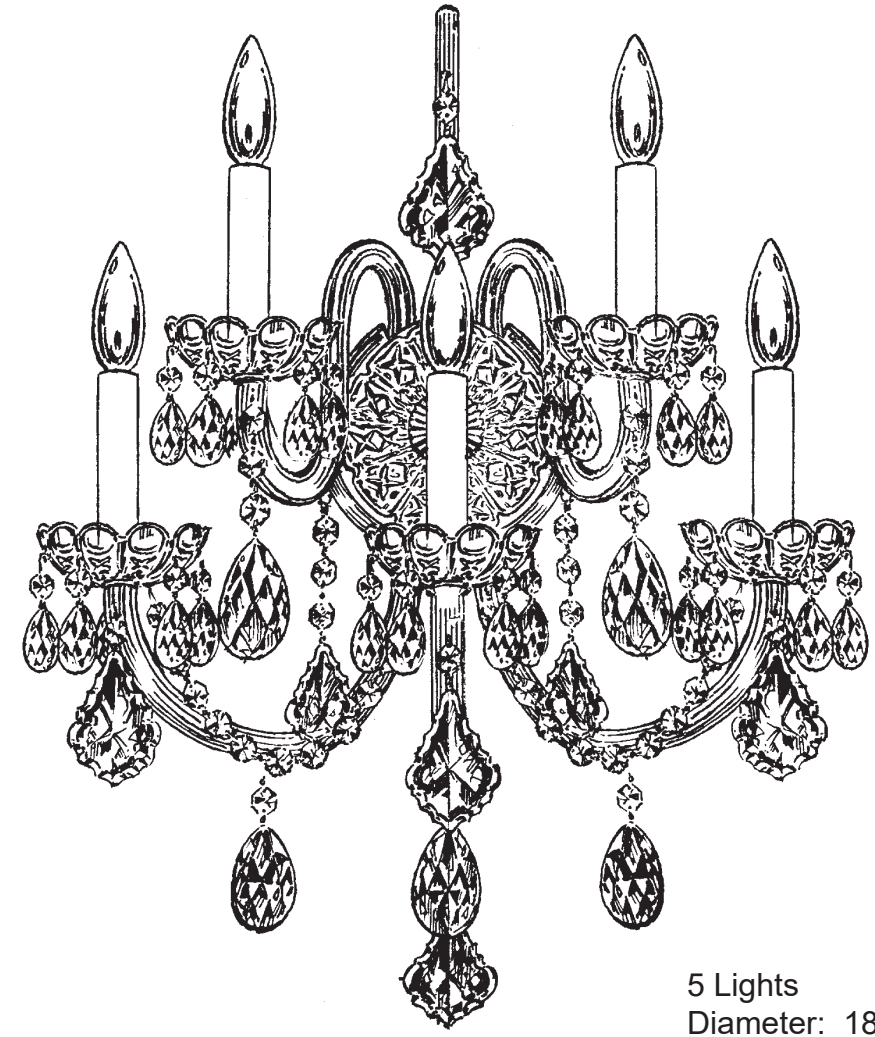









# OLDE WORLD 6806- \_\_\_ \_\_ H



5 Lights  
Diameter: 18"  
Body Length: 23"  
Extension: 9-1/2"  
Hanging Weight: 9 lbs.

**T**HIS DESIGN IS THE PROPRIETARY  
TRADE DRESS/TRADEMARK OF  
W SCHONBEK LLC.

 **SCHONBEK** | 1870

									
MAX <b>60</b> W		110-120 V							

All electrical components must be installed by a licensed electrician in accordance with the National Electric Code and the appropriate local electrical codes.

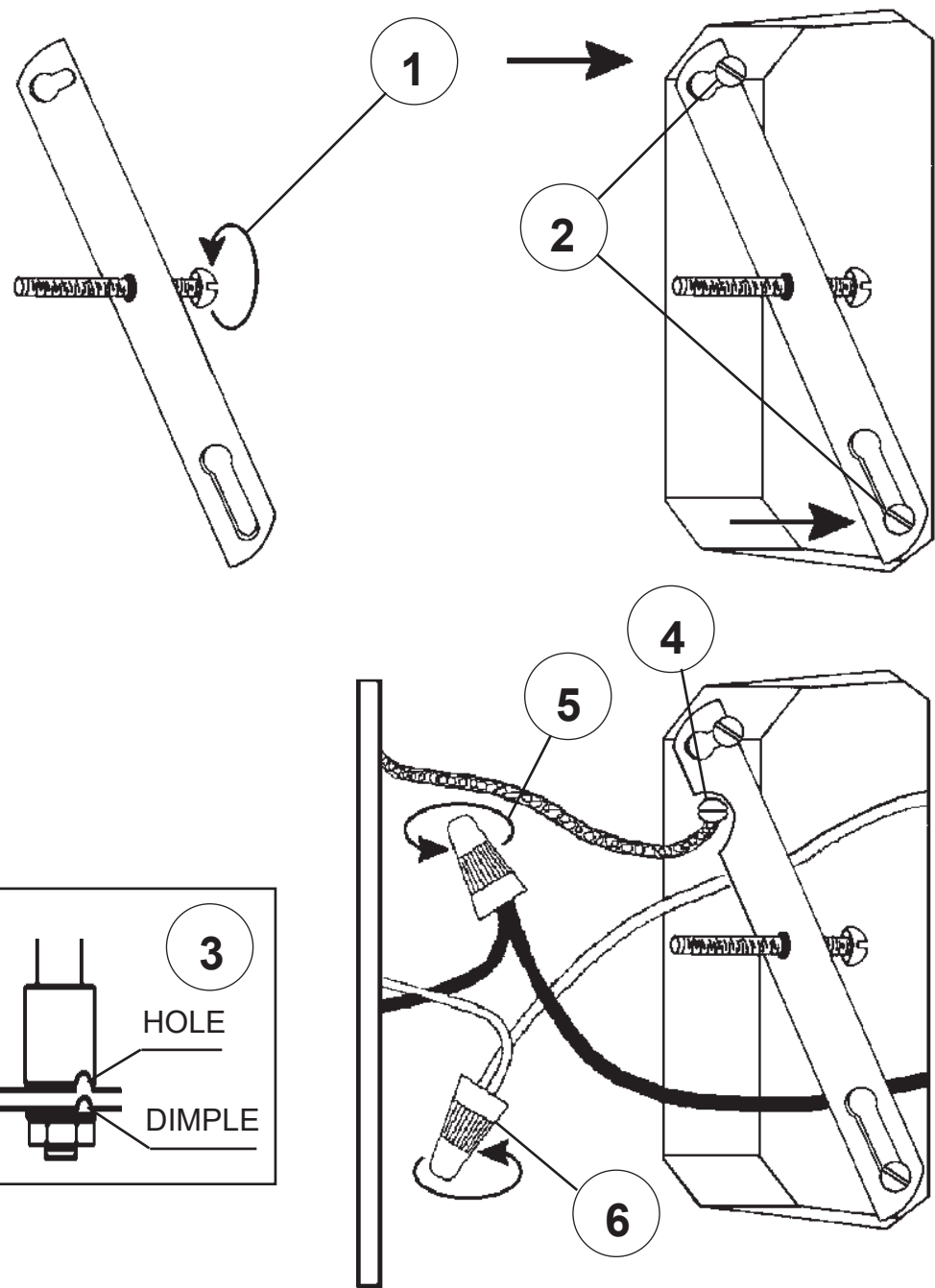

Turn arms to line up holes in arms with dimple in plate. Tighten lock washer and nut to secure arms in place.

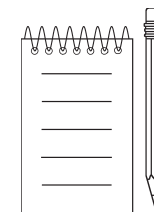
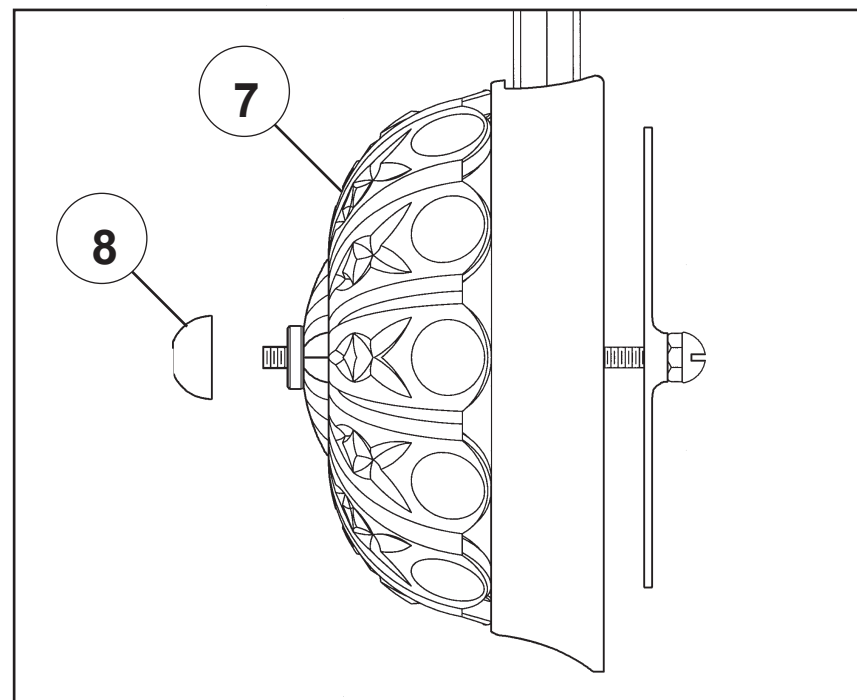
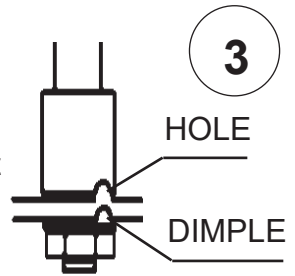

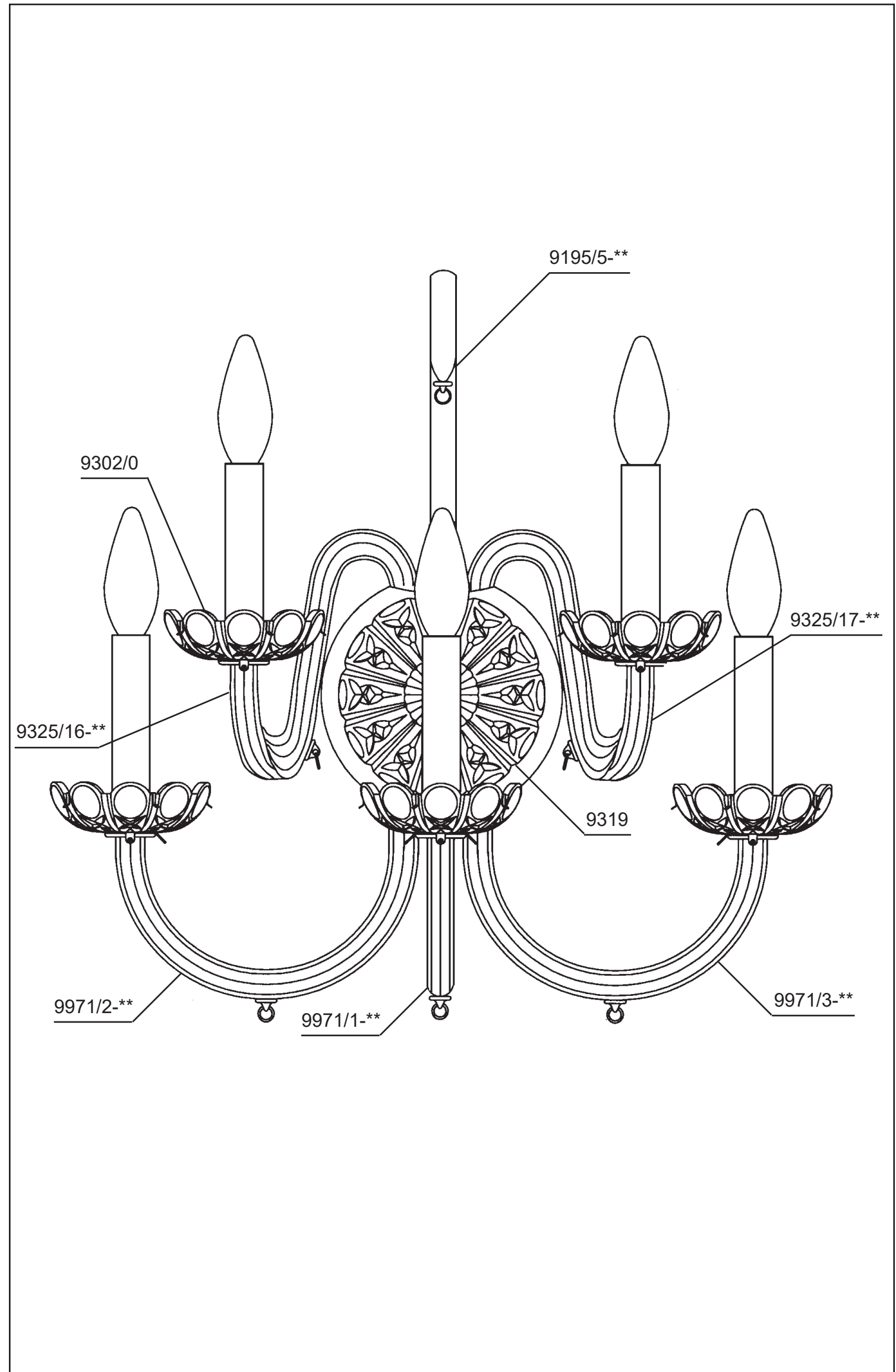
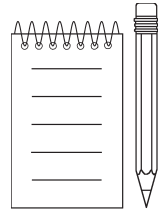



9

You will need 5 - B10  
25 Watts Recommended  
60 Watts Max

Install bulbs and be sure  
to test fixture **BEFORE**  
trimming.

VIEW "A"

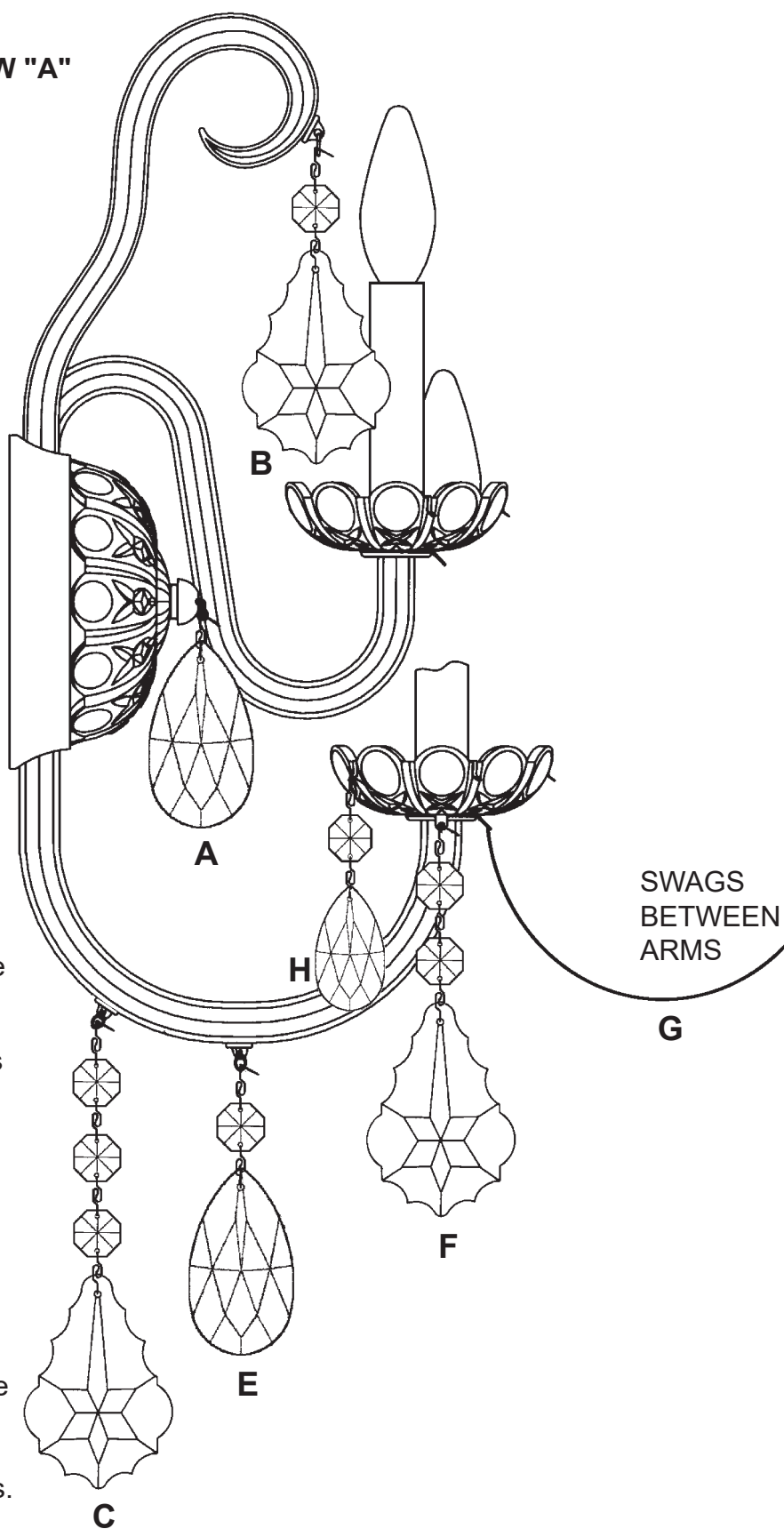

VIEW "B"

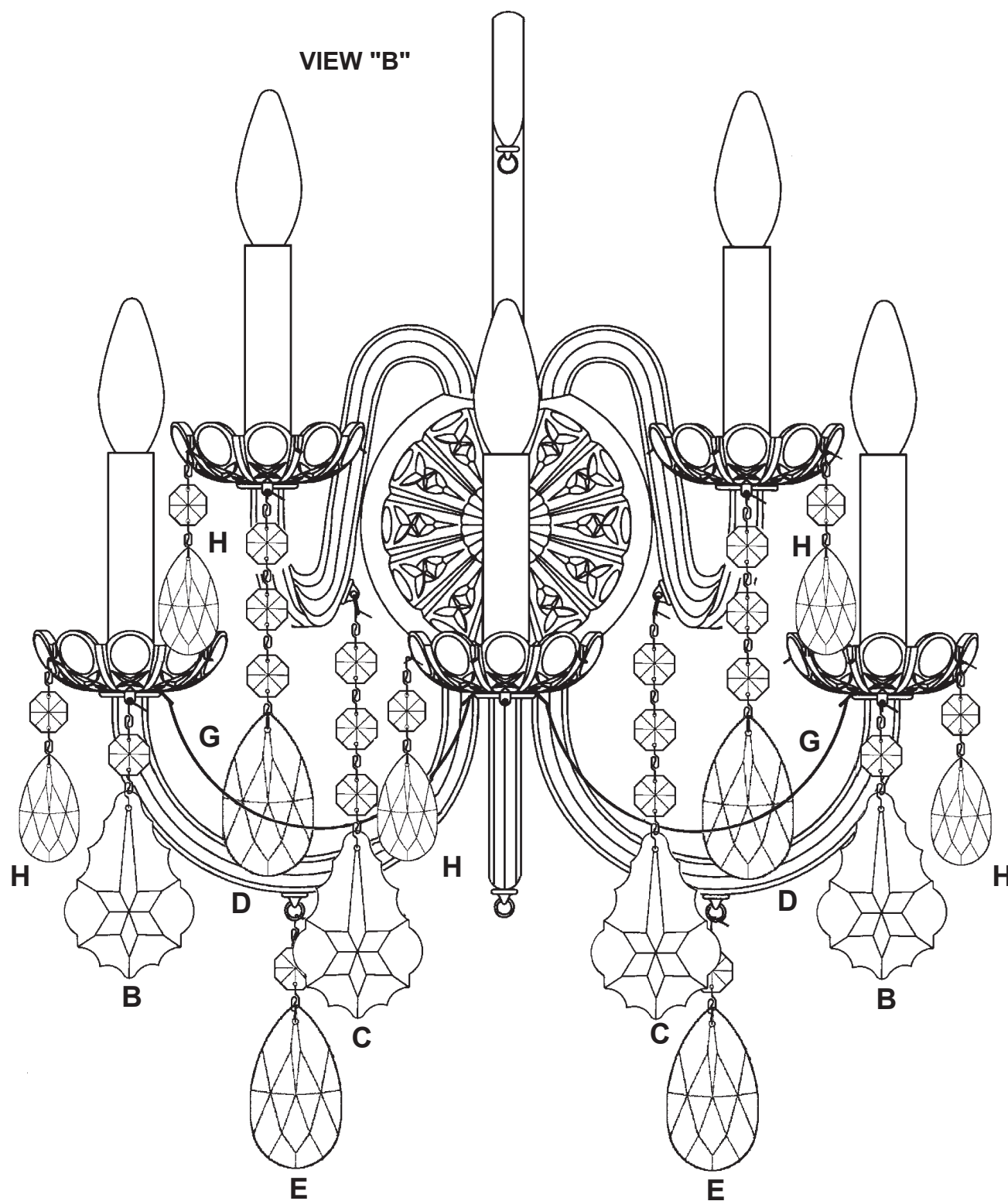

**10** Hook Drop "A" into the pigtail of the center knob. See View "A".

**11** Hook Drop "B" into the ring on the upper center glass scroll. See View "A". Hook Drops "C" and Drop "E" into the rings on the center glass arm. See View "A".

**12** Hook Drops "F" into the front tab under the bobèche on the center glass arm. See View "A".

**13** Hook Drops "C" into the rings of the upper glass arms. See View "B".

**14** Hook Drops "D" into the front tabs under the bobèche on the upper glass arms. See View "B".

**15** Hook Drops "E" into the rings of the lower glass arms. See View "B".

**16** Hook Drops "B" into the center tabs on the lower glass arms. See View "B".

**17** Hook Chains "G" into the side tabs under the lower glass arm bobèche. Hook the other end into the side tabs under the center glass arm bobèche. Chains "G" are swagged between the center glass arm and the outside glass arms. See View "B".

**18** Every bobèche is trimmed with Drops "H", suspended from every bracket between the scallops. See View "B".



 **SCHONBEK** | 1870



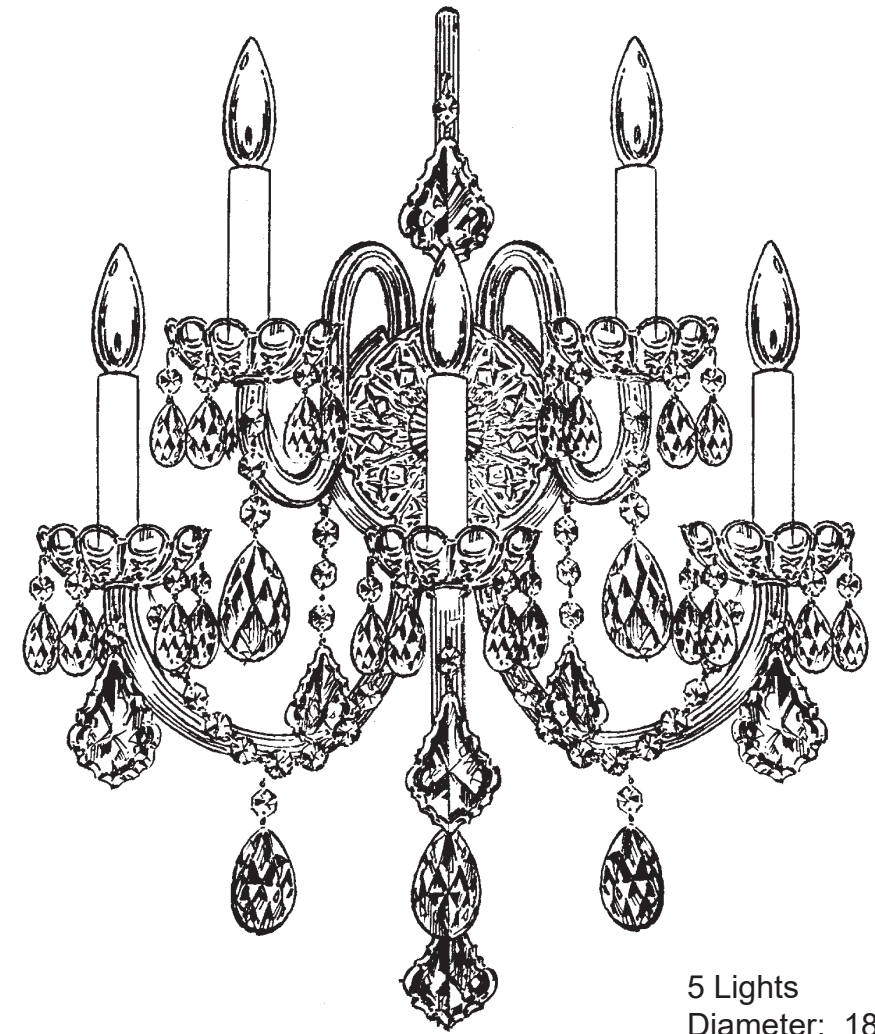







# OLDE WORLD 6806-\_\_ \_\_R



5 Lights  
Diameter: 18"  
Body Length: 23"  
Extension: 9-1/2"  
Hanging Weight: 9 lbs.

**T**HIS DESIGN IS THE PROPRIETARY TRADE DRESS/TRADEMARK OF W SCHONBEK LLC.

 **SCHONBEK** | 1870

								
MAX <b>60</b> W		110-120 V						



All electrical components must be installed by a licensed electrician in accordance with the National Electric Code and the appropriate local electrical codes.

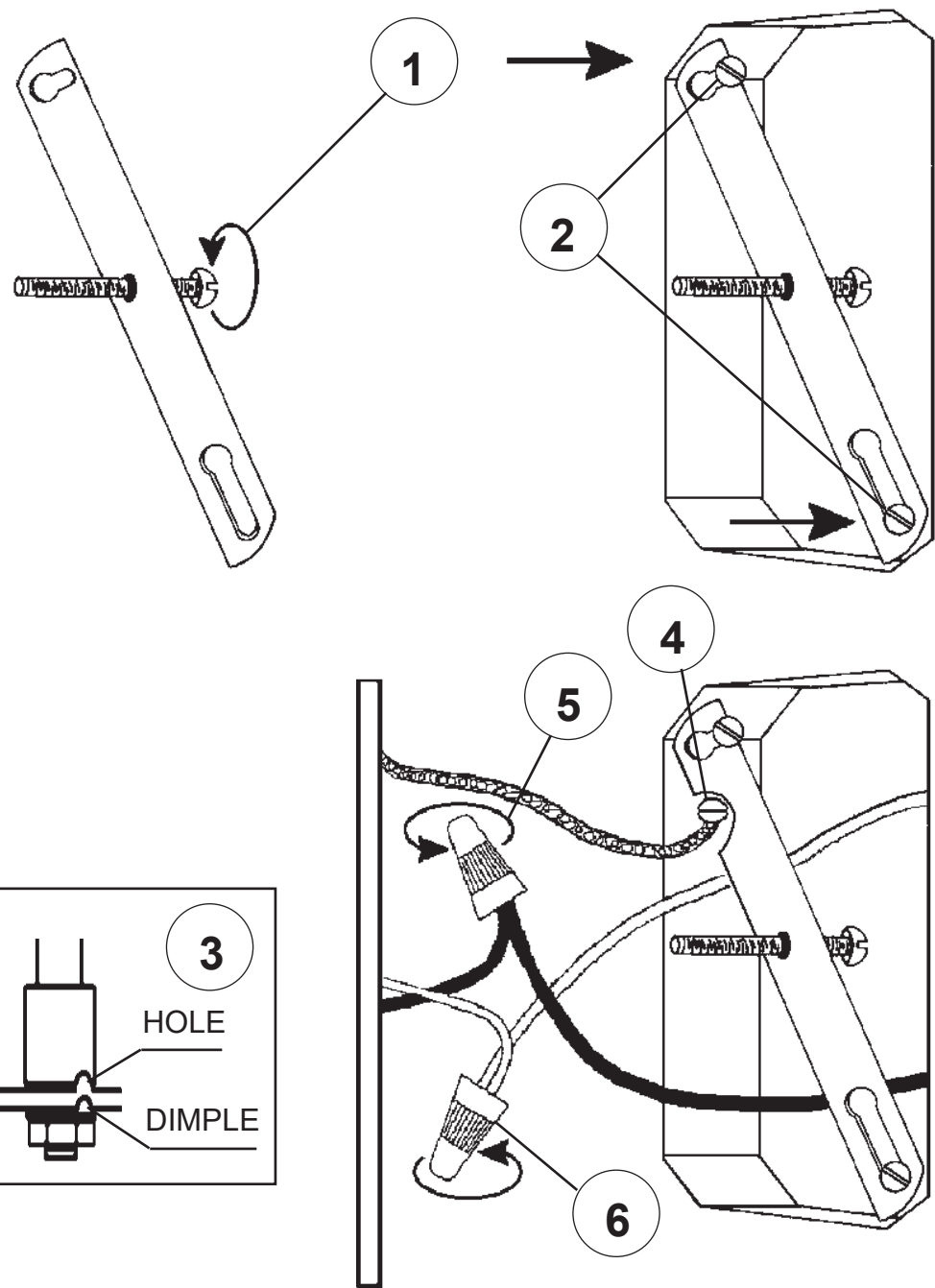

Turn arms to line up holes in arms with dimple in plate. Tighten lock washer and nut to secure arms in place.

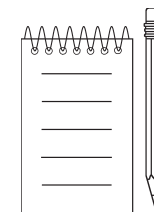

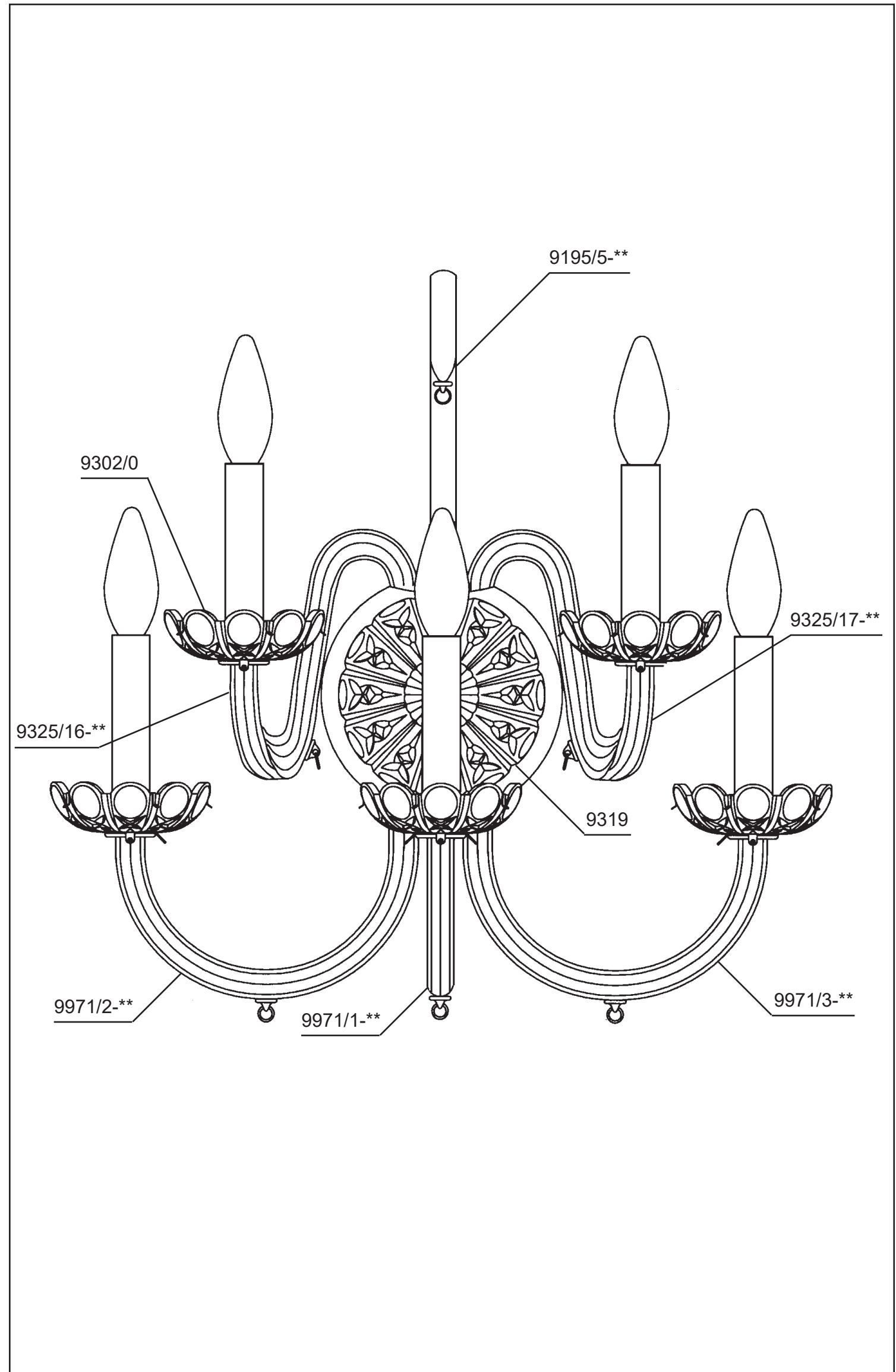
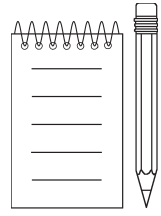



9

You will need 5 - B10  
25 Watts Recommended  
60 Watts Max

Install bulbs and be sure  
to test fixture **BEFORE**  
trimming.

VIEW "A"

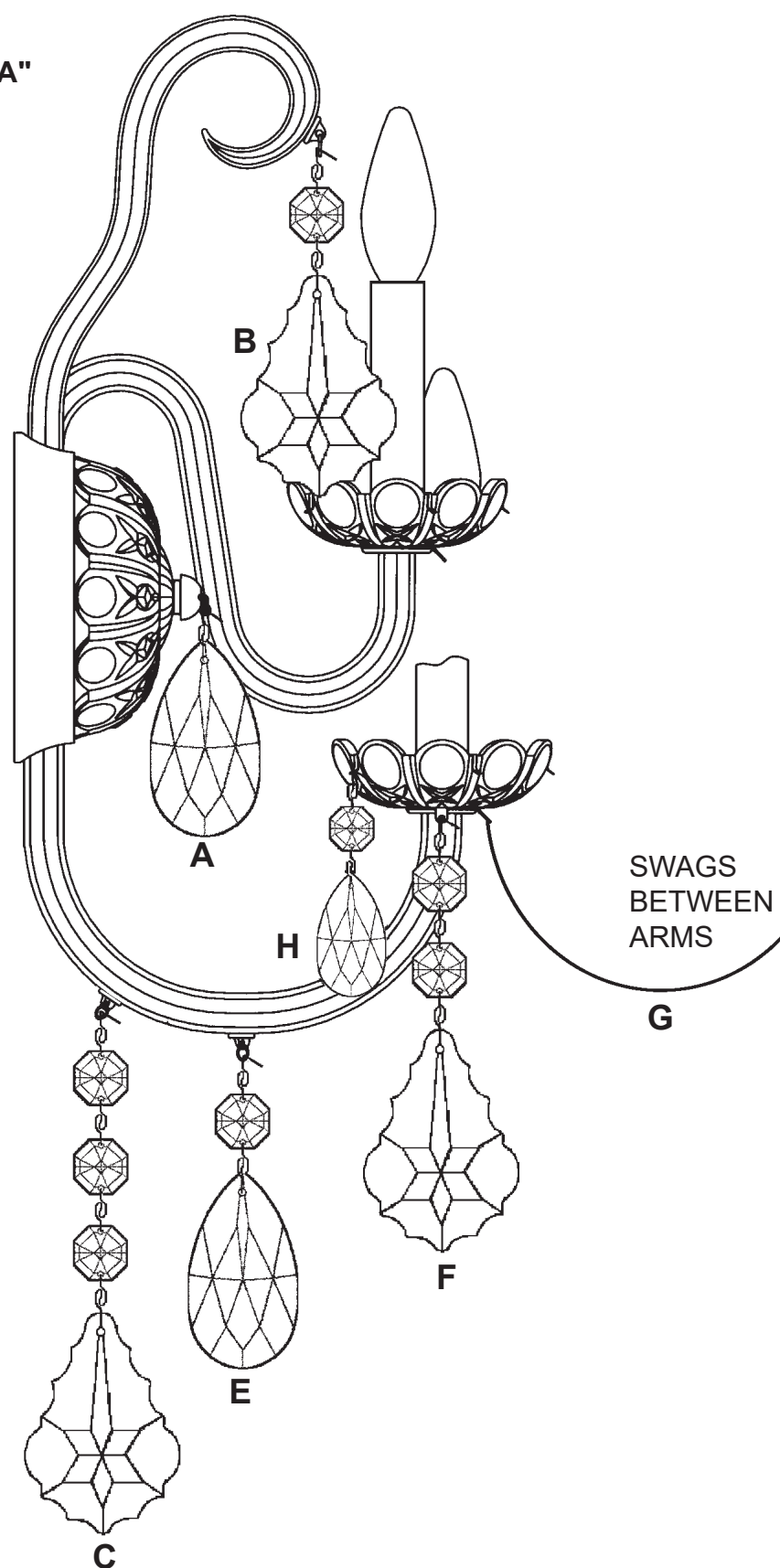

VIEW "B"

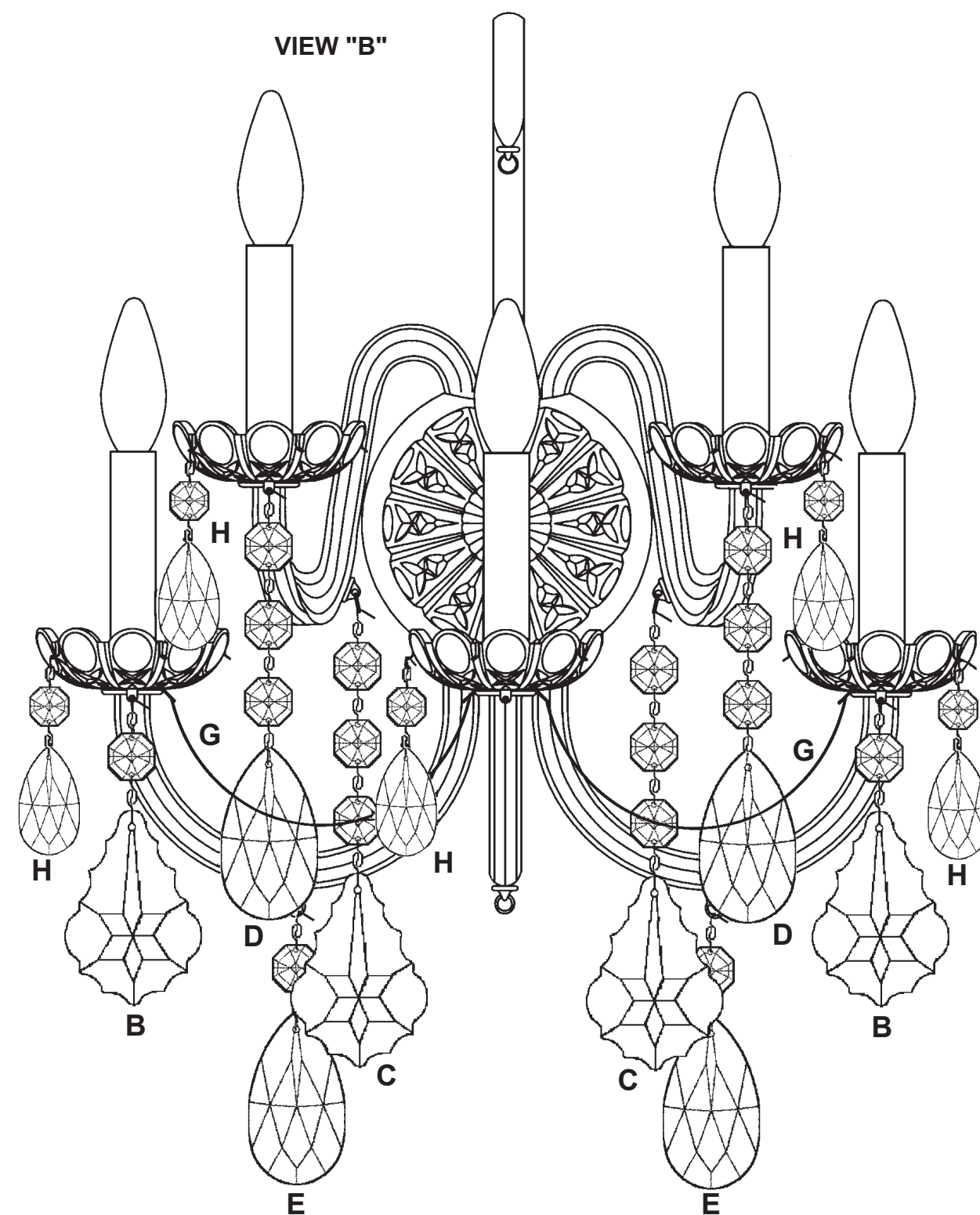

**10** Hook Drop "A" into the pigtail of the center knob. See View "A".

**11** Hook Drop "B" into the ring on the upper center glass scroll. See View "A". Hook Drops "C" and Drop "E" into the rings on the center glass arm. See View "A".

**12** Hook Drops "F" into the front tab under the bobèche on the center glass arm. See View "A".

**13** Hook Drops "C" into the rings of the upper glass arms. See View "B".

**14** Hook Drops "D" into the front tabs under the bobèche on the upper glass arms. See View "B".

**15** Hook Drops "E" into the rings of the lower glass arms. See View "B".

**16** Hook Drops "B" into the center tabs on the lower glass arms. See View "B".

**17** Hook Chains "G" into the side tabs under the lower glass arm bobèche. Hook the other end into the side tabs under the center glass arm bobèche. Chains "G" are swagged between the center glass arm and the outside glass arms. See View "B".

**18** Every bobèche is trimmed with Drops "H", suspended from every bracket between the scallops. See View "B".





OLDE WORLD 6806- \_\_\_ \_\_S

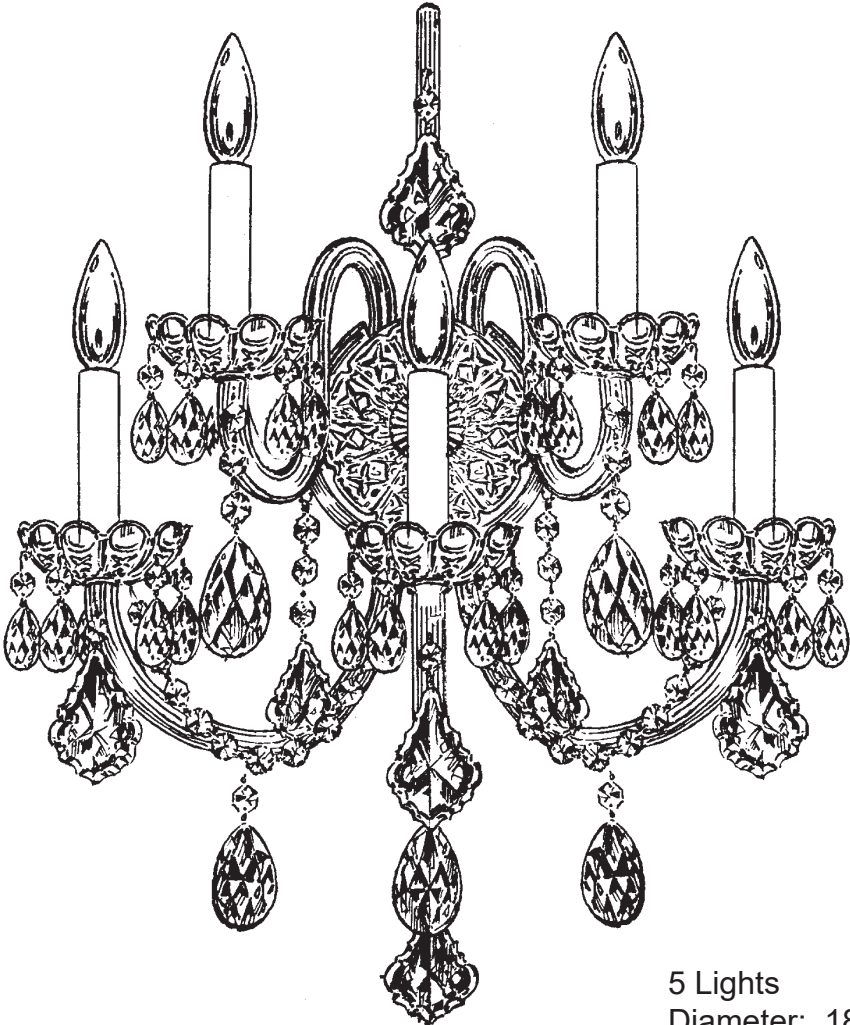











5 Lights  
Diameter: 18"  
Body Length: 23"  
Extension: 9-1/2"  
Hanging Weight: 9 lbs.

**T**HIS DESIGN IS THE PROPRIETARY  
TRADE DRESS/TRADEMARK OF  
W SCHONBEK LLC.

 **SCHONBEK** | 1870

 **SCHONBEK** | 1870

								
MAX <b>60</b> W		110-120 V						

All electrical components must be installed by a licensed electrician in accordance with the National Electric Code and the appropriate local electrical codes.

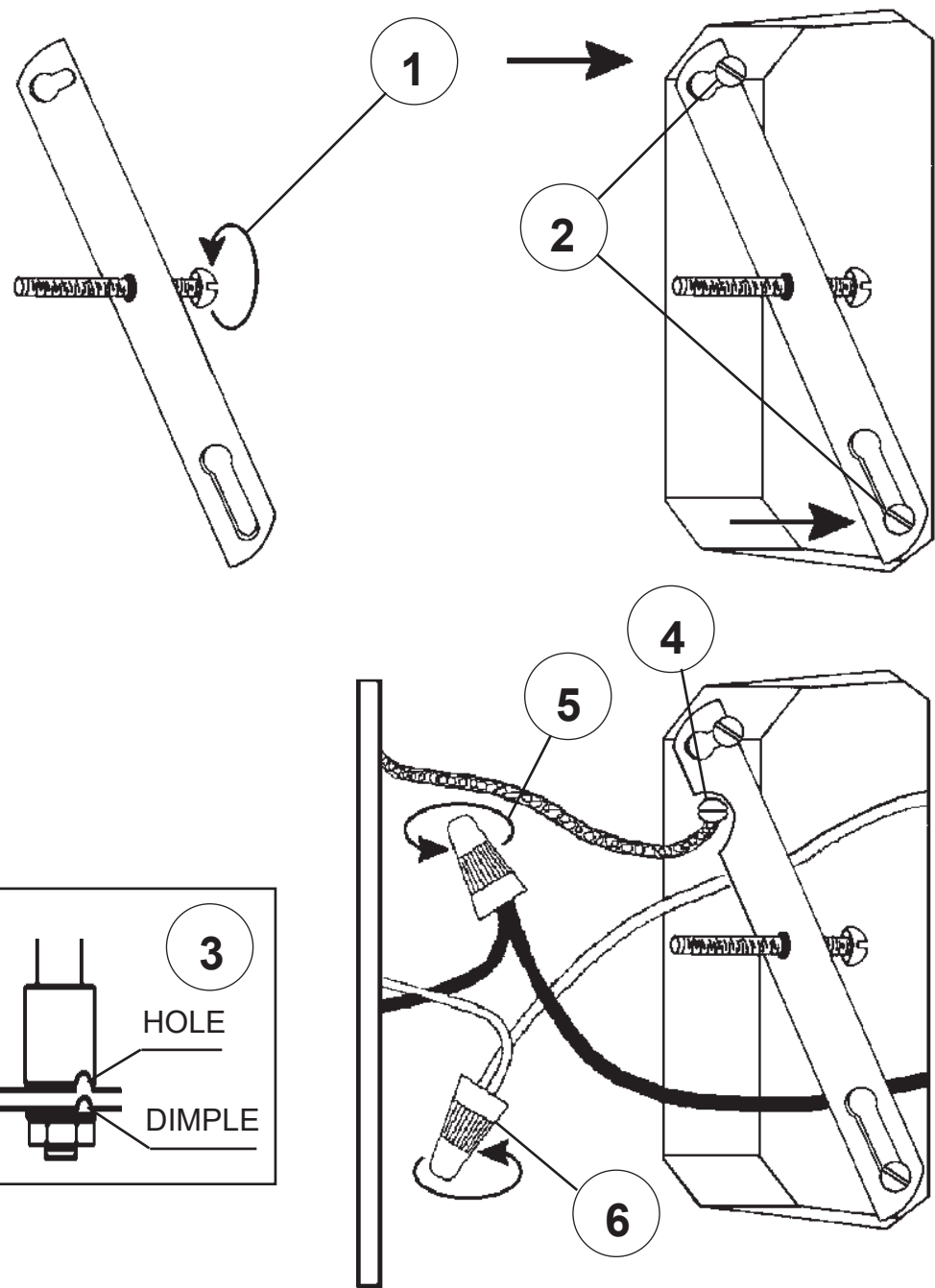

Turn arms to line up holes in arms with dimple in plate. Tighten lock washer and nut to secure arms in place.

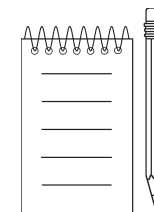
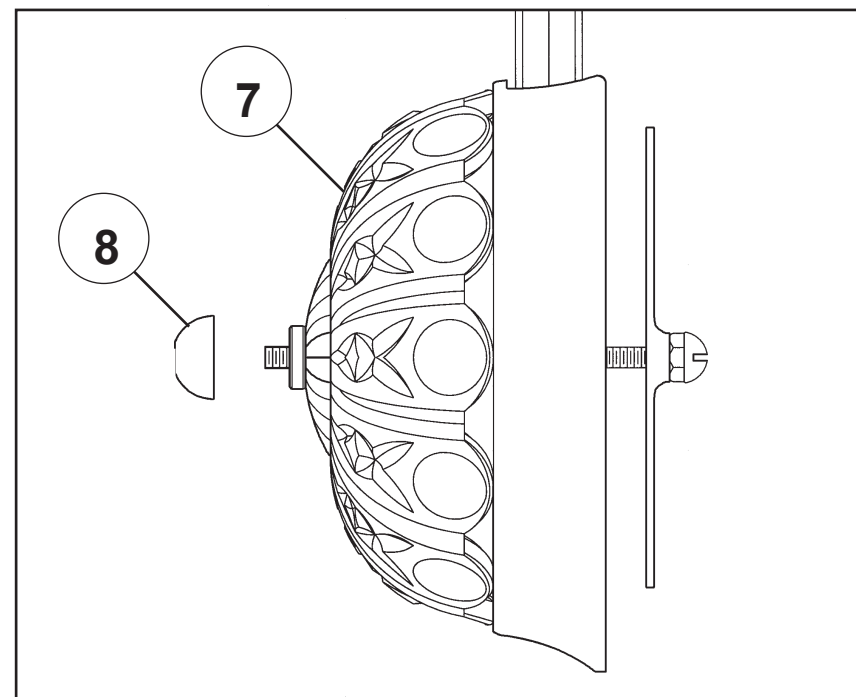

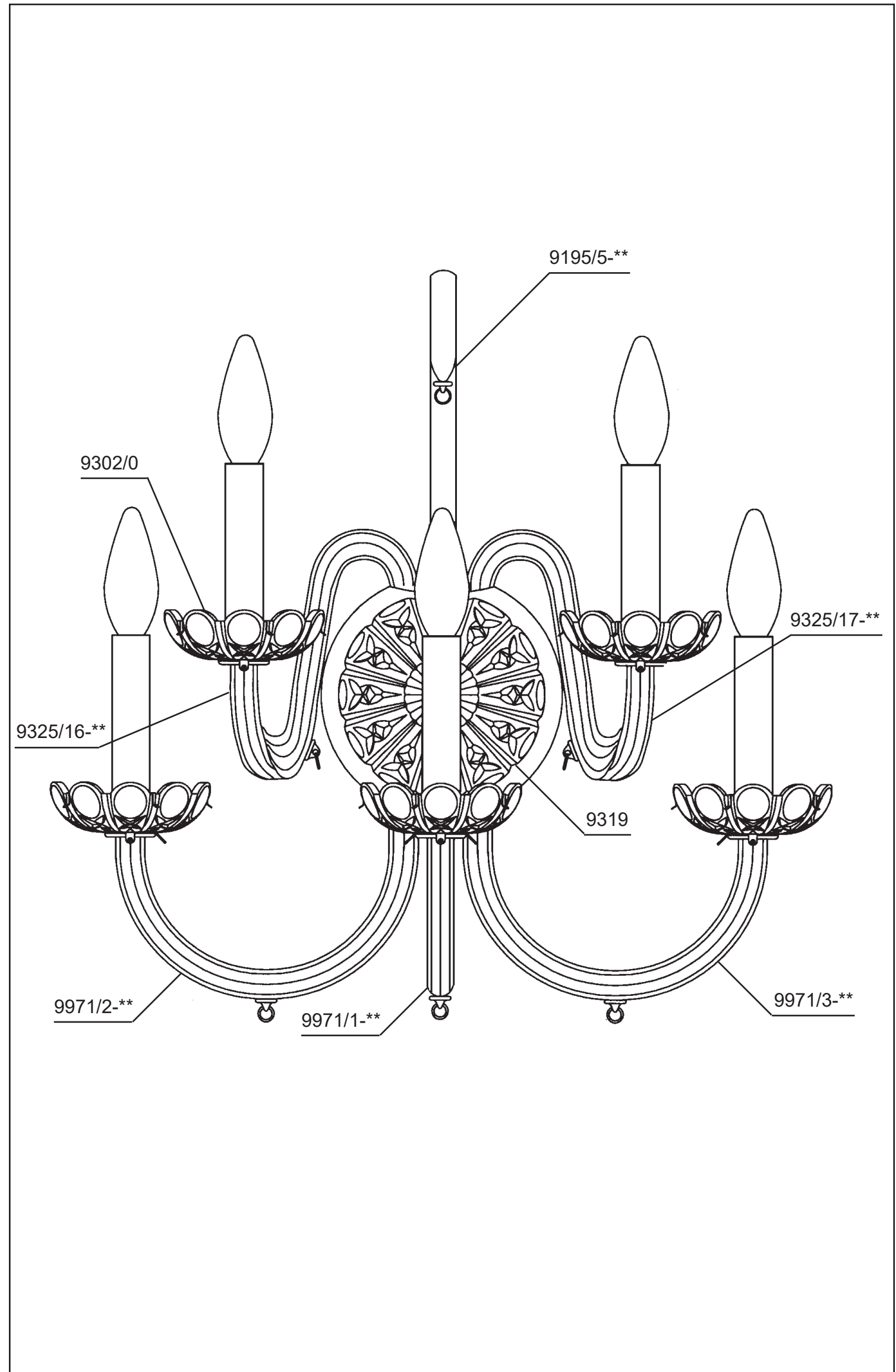
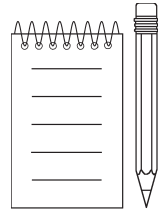



9

You will need 5 - B10  
25 Watts Recommended  
60 Watts Max

Install bulbs and be sure  
to test fixture **BEFORE**  
trimming.

VIEW "A"

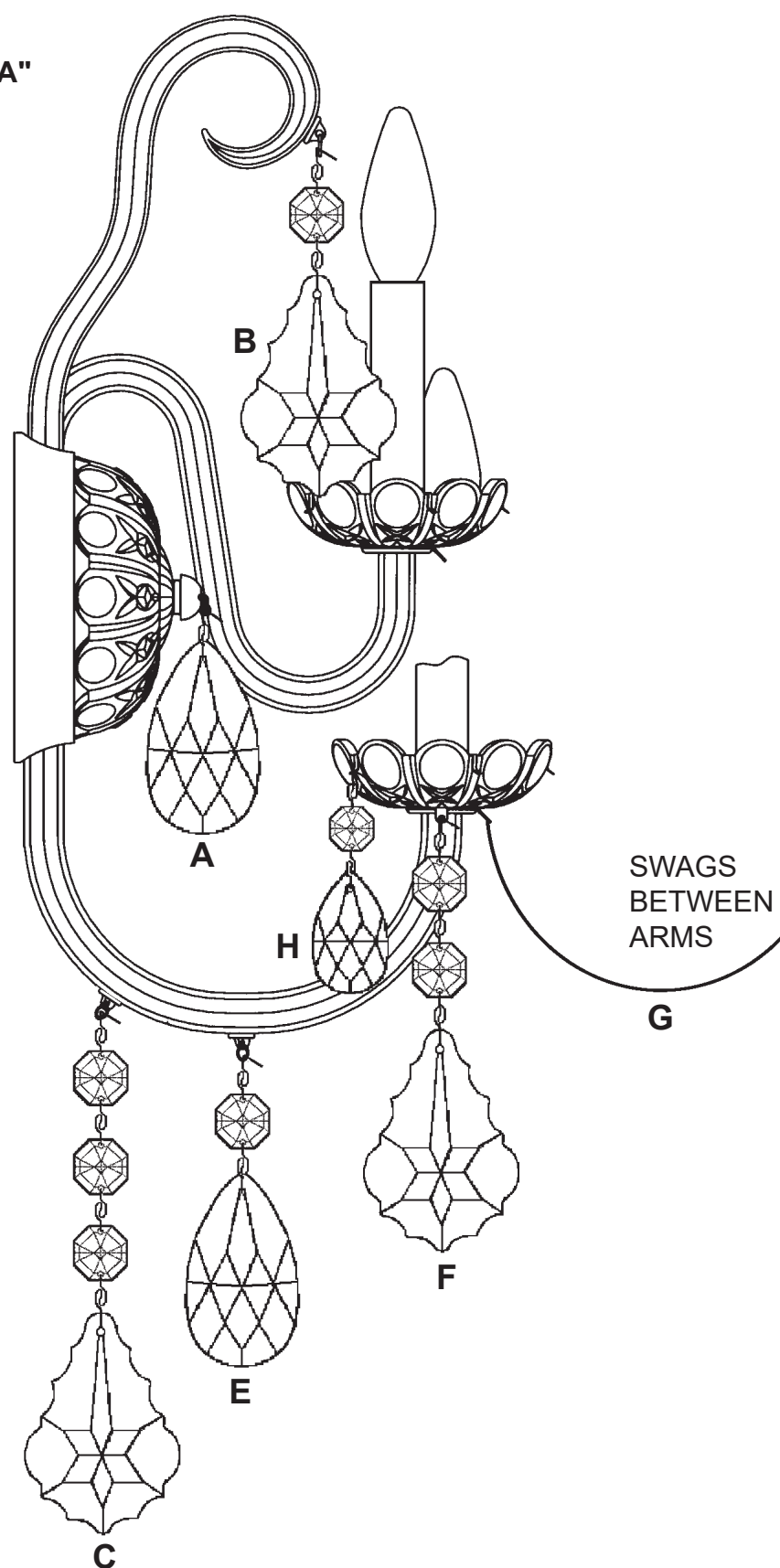

VIEW "B"

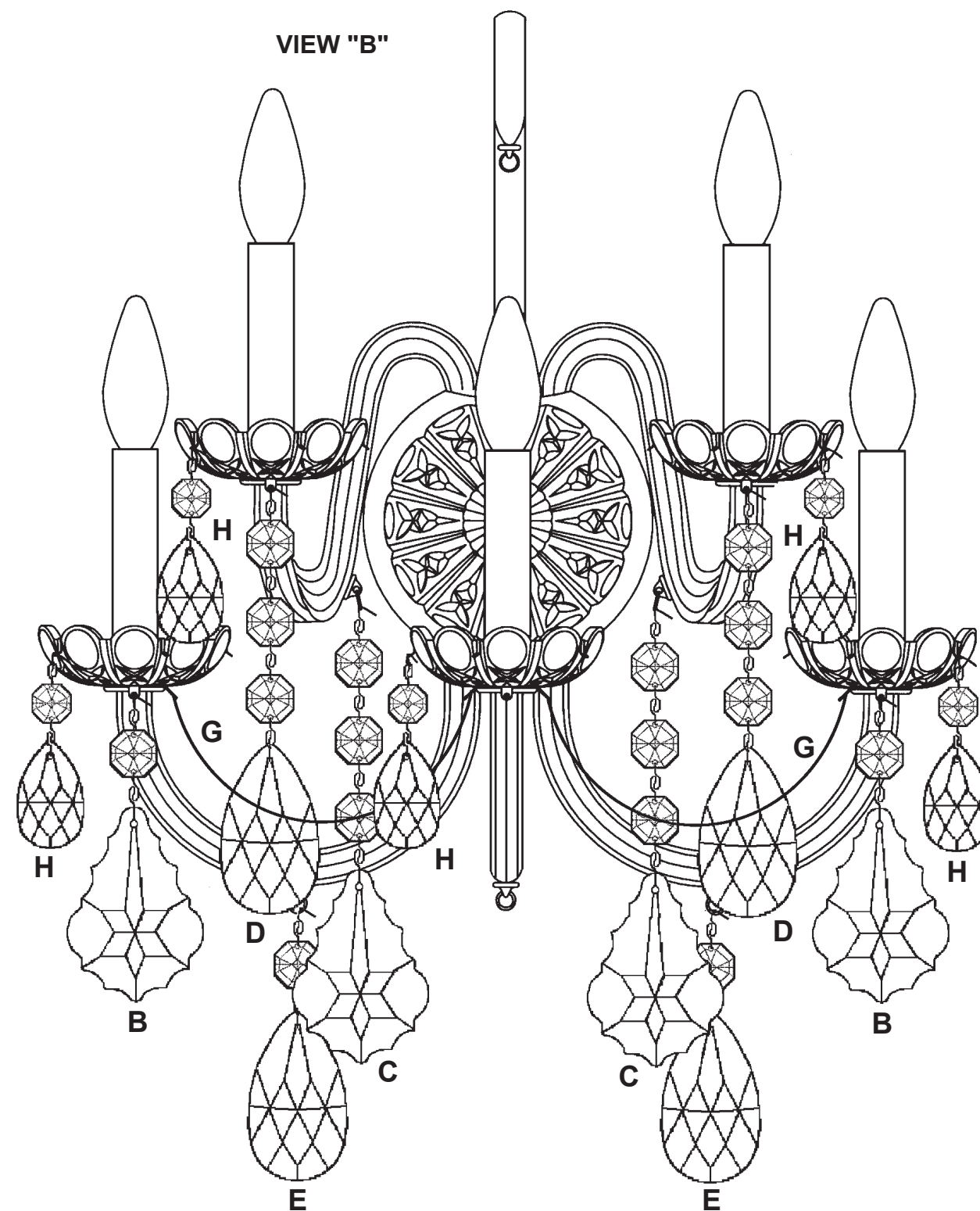

**10** Hook Drop "A" into the pigtail of the center knob. See View "A".

**11** Hook Drop "B" into the ring on the upper center glass scroll. See View "A". Hook Drops "C" and Drop "E" into the rings on the center glass arm. See View "A".

**12** Hook Drops "F" into the front tab under the bobèche on the center glass arm. See View "A".

**13** Hook Drops "C" into the rings of the upper glass arms. See View "B".

**14** Hook Drops "D" into the front tabs under the bobèche on the upper glass arms. See View "B".

**15** Hook Drops "E" into the rings of the lower glass arms. See View "B".

**16** Hook Drops "B" into the center tabs on the lower glass arms. See View "B".

**17** Hook Chains "G" into the side tabs under the lower glass arm bobèche. Hook the other end into the side tabs under the center glass arm bobèche. Chains "G" are swagged between the center glass arm and the outside glass arms. See View "B".

**18** Every bobèche is trimmed with Drops "H", suspended from every bracket between the scallops. See View "B".

