

 **SCHONBEK** | 1870

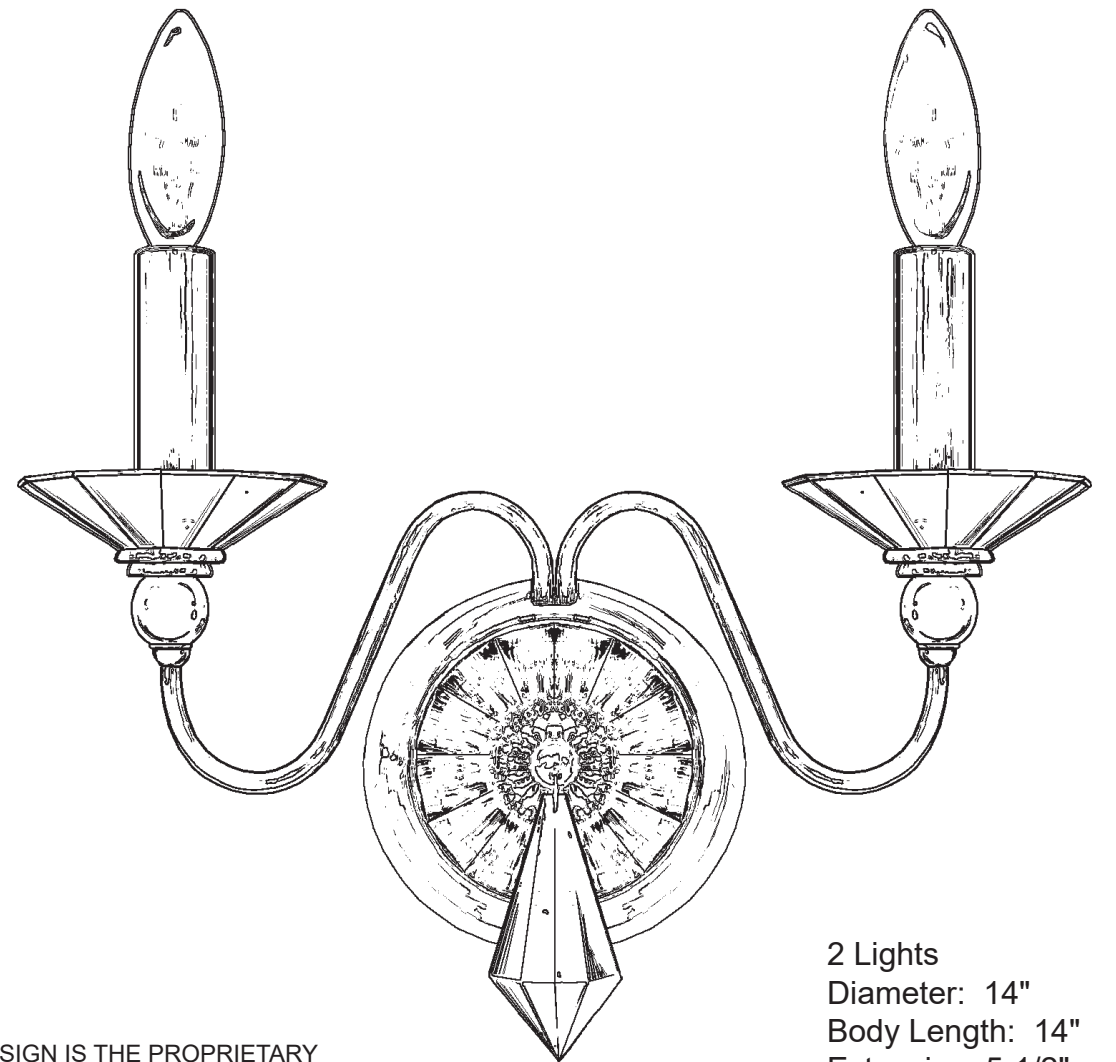









JASMINE 9672- _____



2 Lights
Diameter: 14"
Body Length: 14"
Extension: 5-1/2"
Hanging Weight: 3 lbs.

THIS DESIGN IS THE PROPRIETARY TRADE DRESS/TRADEMARK OF W SCHONBEK LLC.

 **SCHONBEK** | 1870

								
MAX 60 W		110-120 V						

All electrical components must be installed by a licensed electrician in accordance with the National Electric Code and the appropriate local electrical codes.

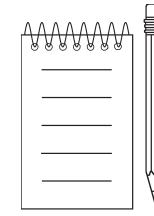
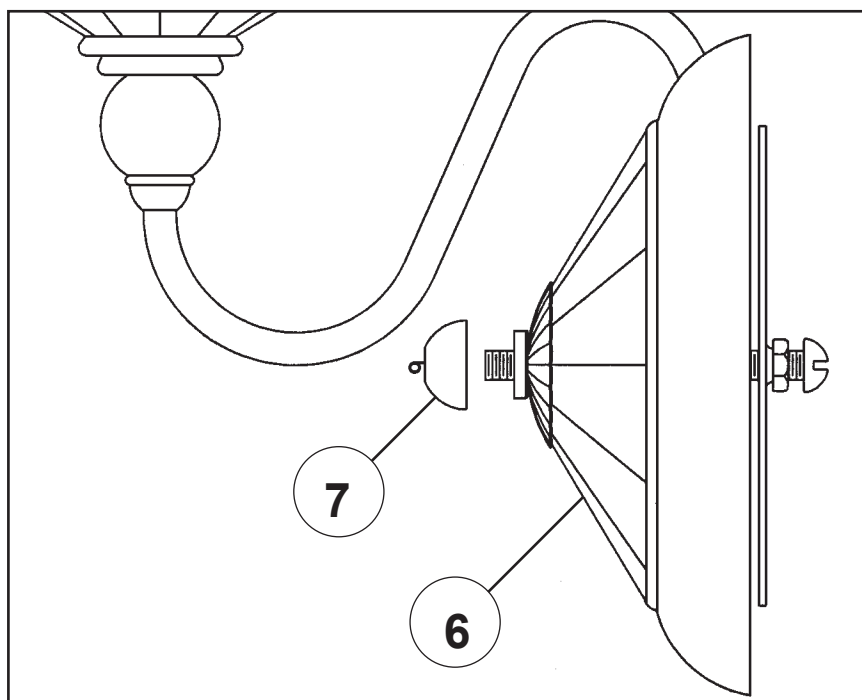
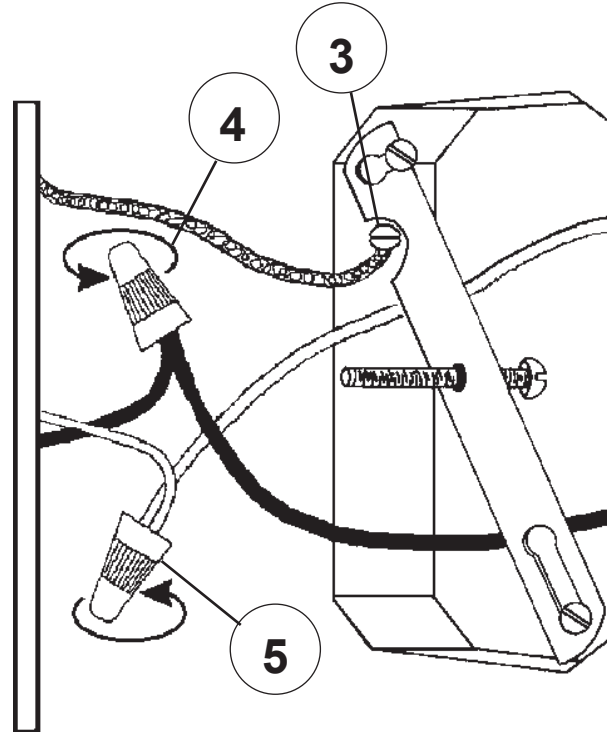
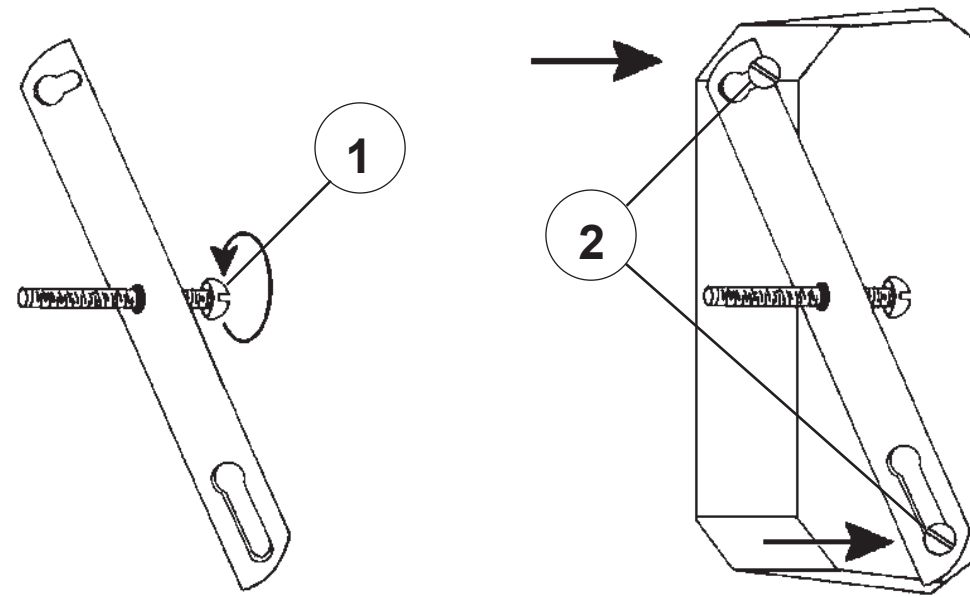



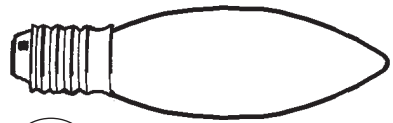

12

You will need 2 - B10
25 Watts Recommended
60 Watts Max

**Install bulb and be sure
to test fixture BEFORE
trimming.**

11

90191/300
glass candle slip
sits on top of
bobeche 90182-**

10

9

90182-**

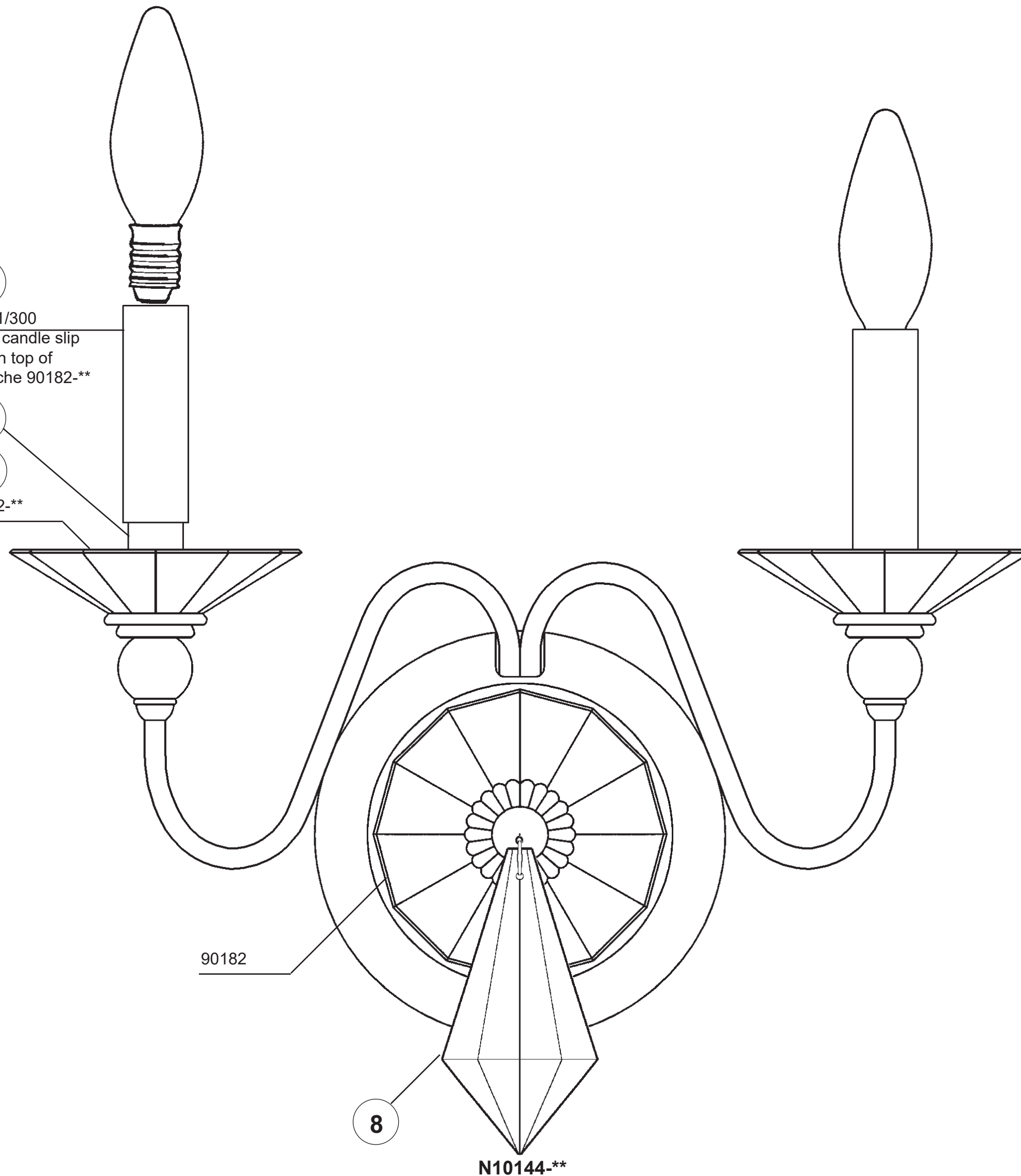

90182

8

N10144-**

