

ESMERY AR1008N-__ __O

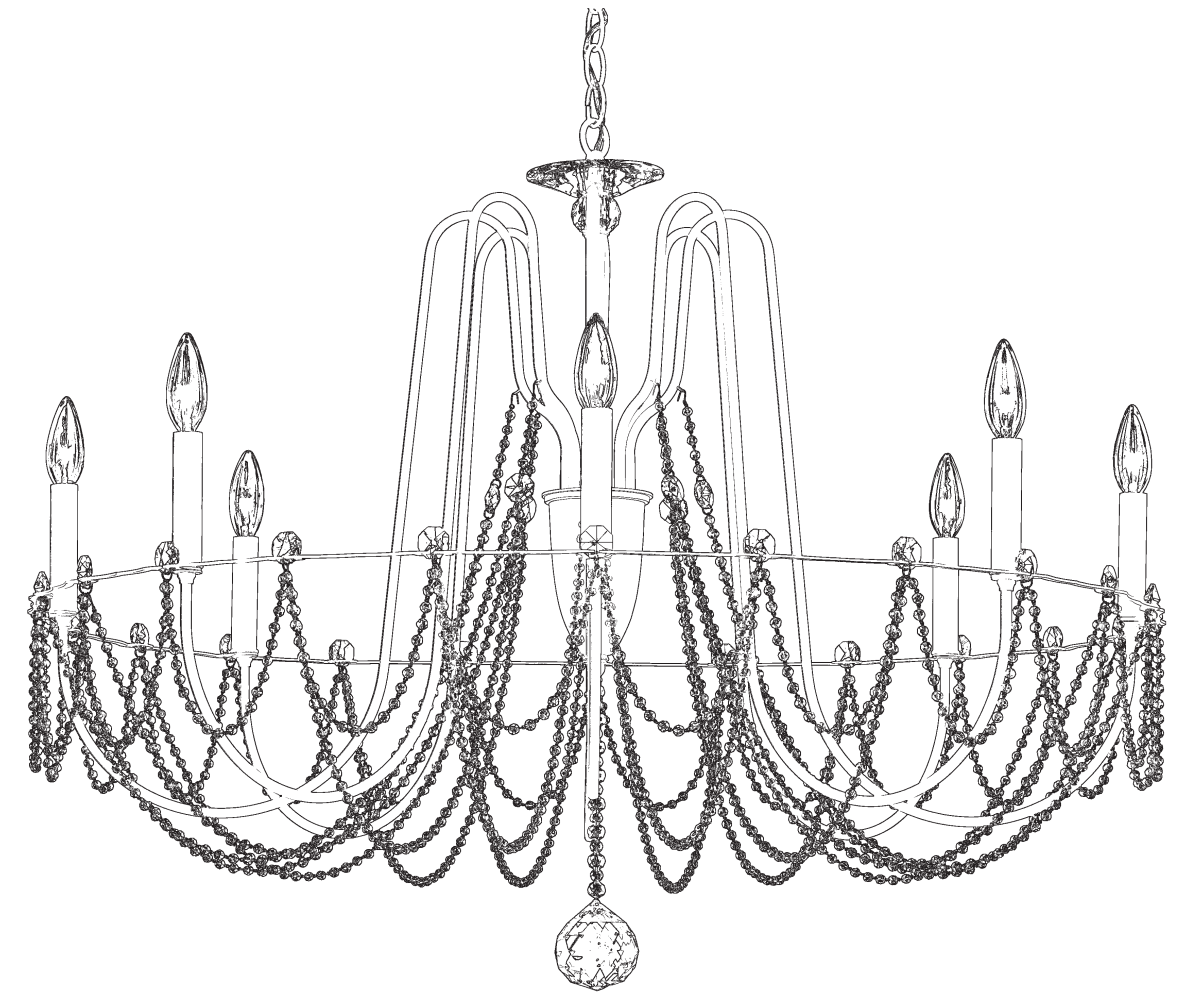











8 Lights
Diameter: 37"
Height: 28-1/2"
Hanging Weight: 13lbs.

THIS DESIGN IS THE PROPRIETARY
TRADE DRESS/TRADemark OF
W SCHONBEK LLC.

 **SCHONBEK** | 1870

 **SCHONBEK** | 1870

								
MAX 60 W		110-120 V						

WARNING:

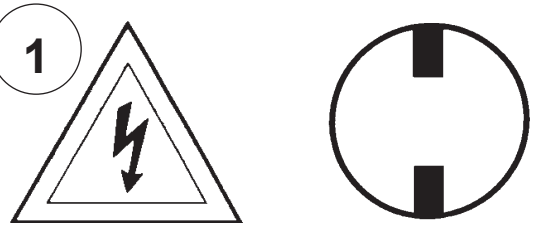
1 

Electrical Danger Turn Power Off

All electrical components must be installed by a licensed electrician in accordance with the National Electric Code and the appropriate local electrical codes.

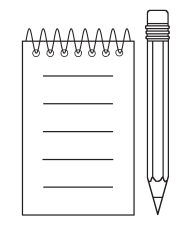
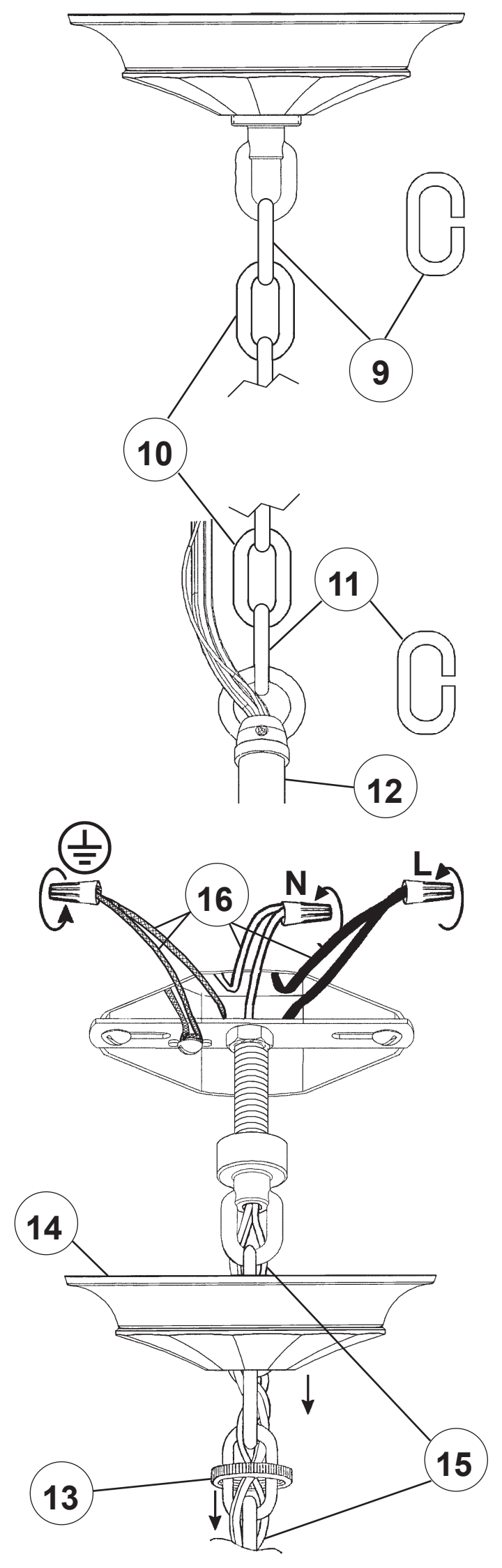
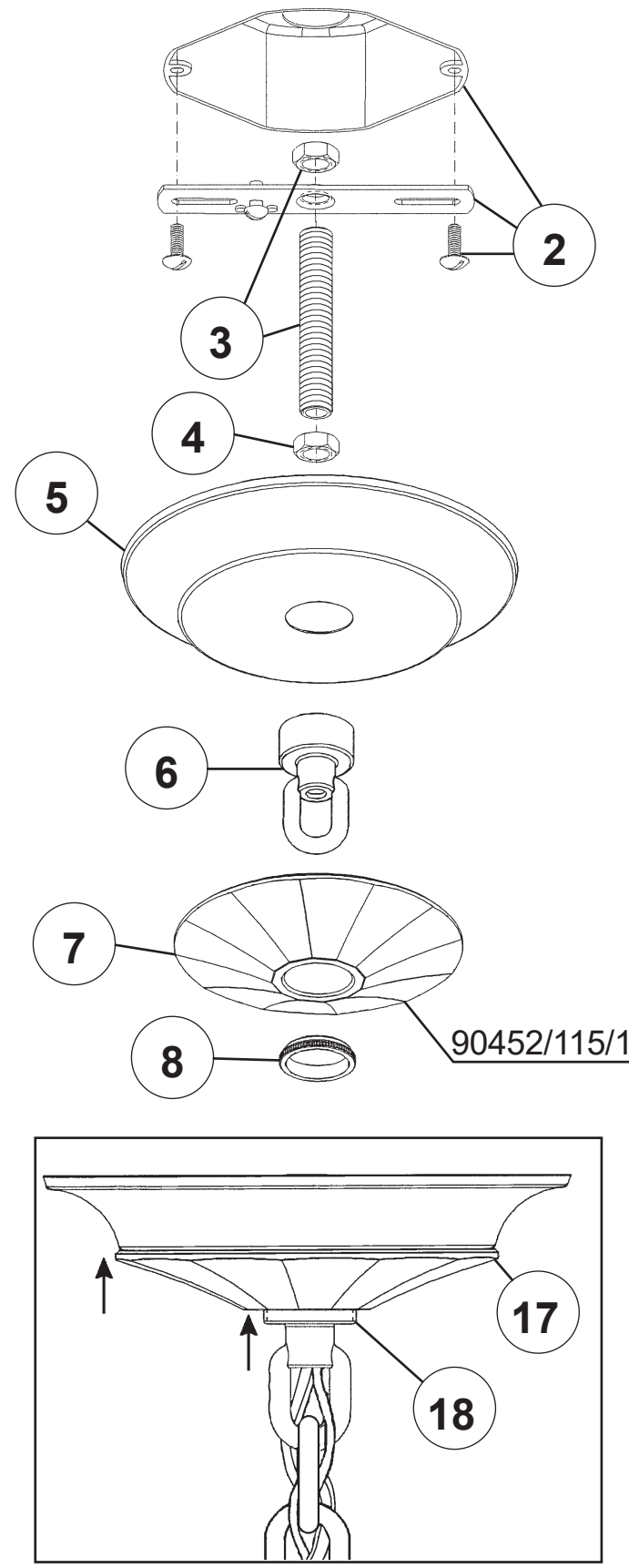

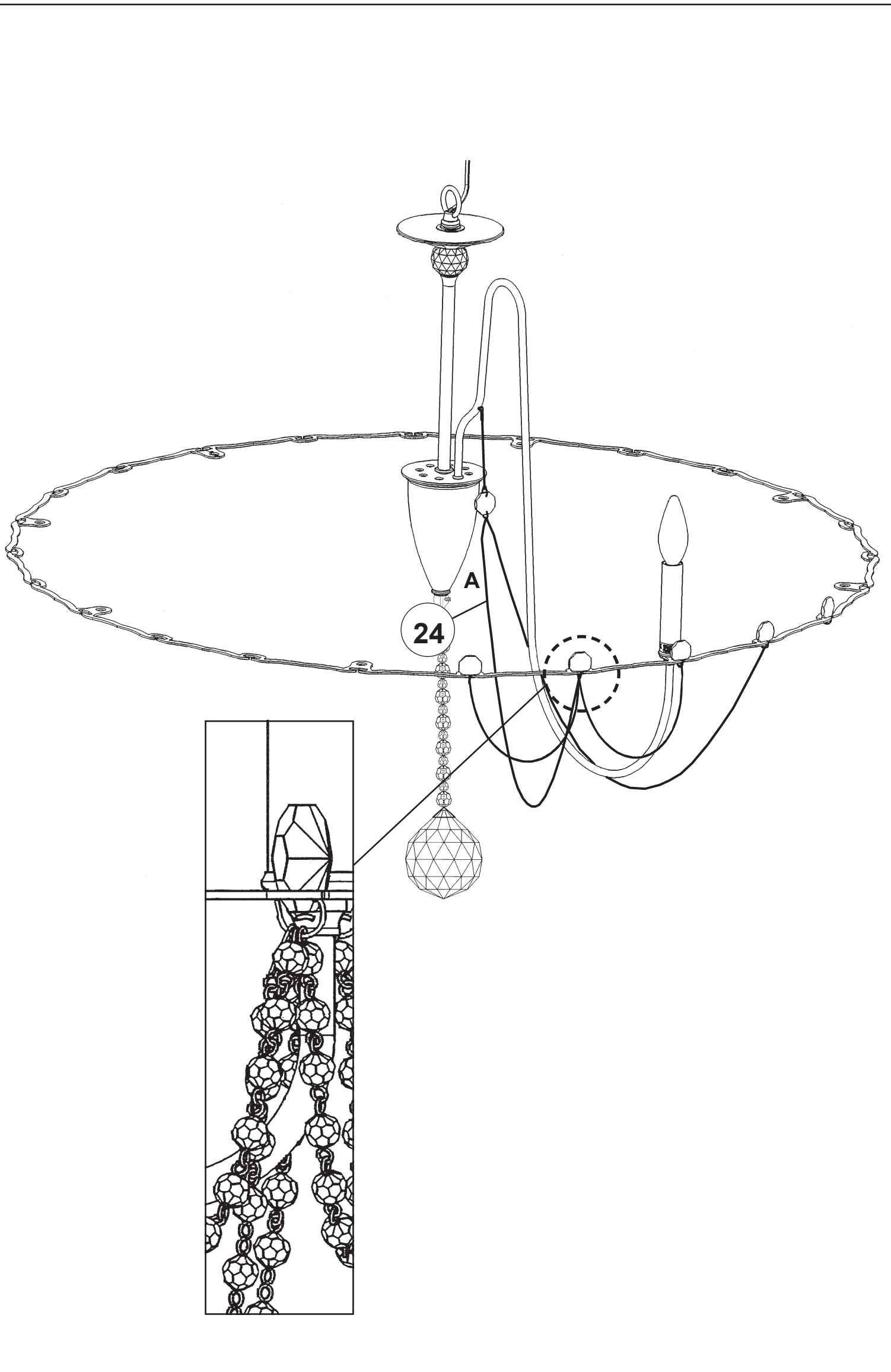

19



You will need 8 - B10
25 Watts Recommended
60 Watts Max

**Install bulbs and be sure
to test fixture BEFORE
trimming.**

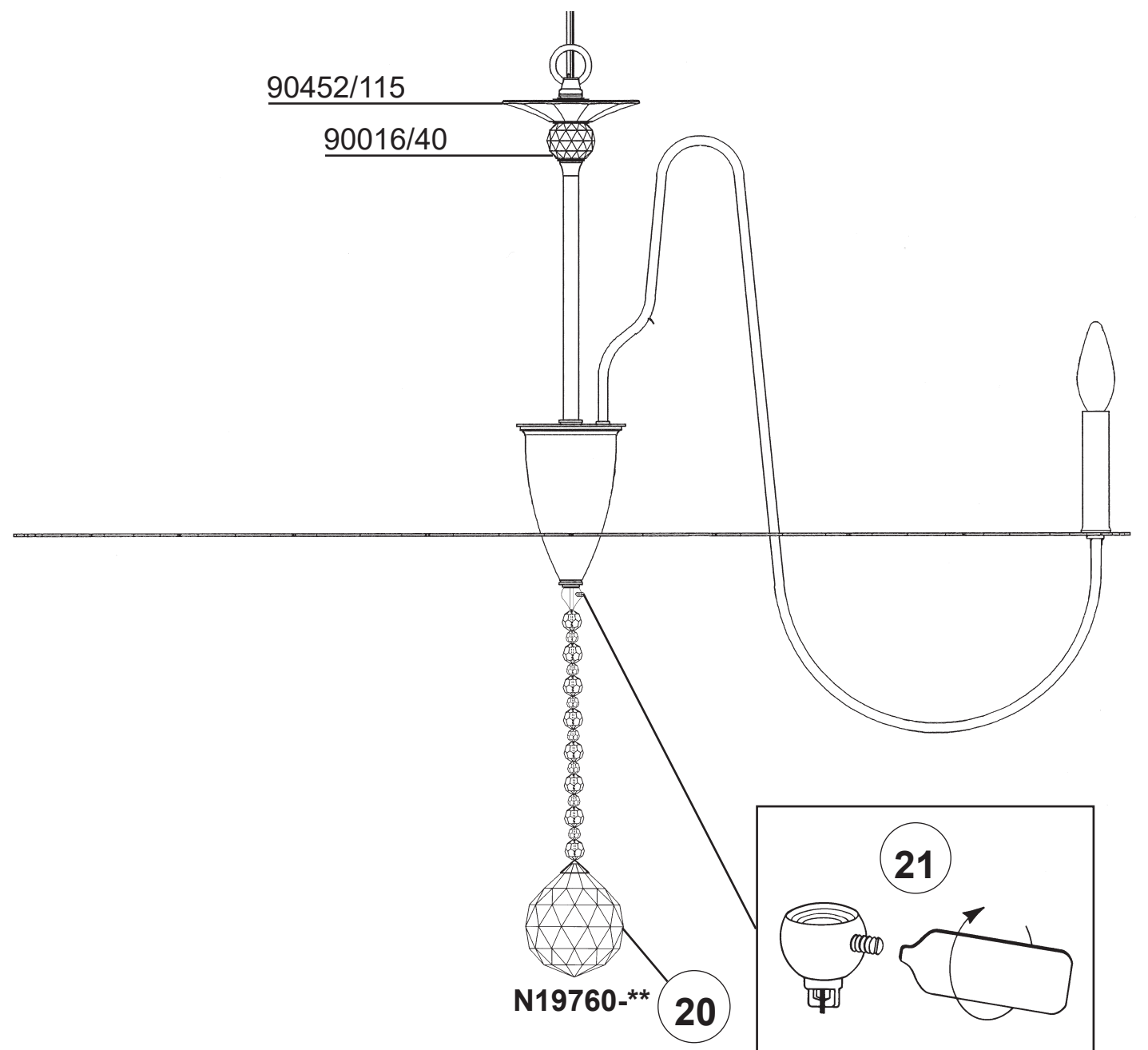

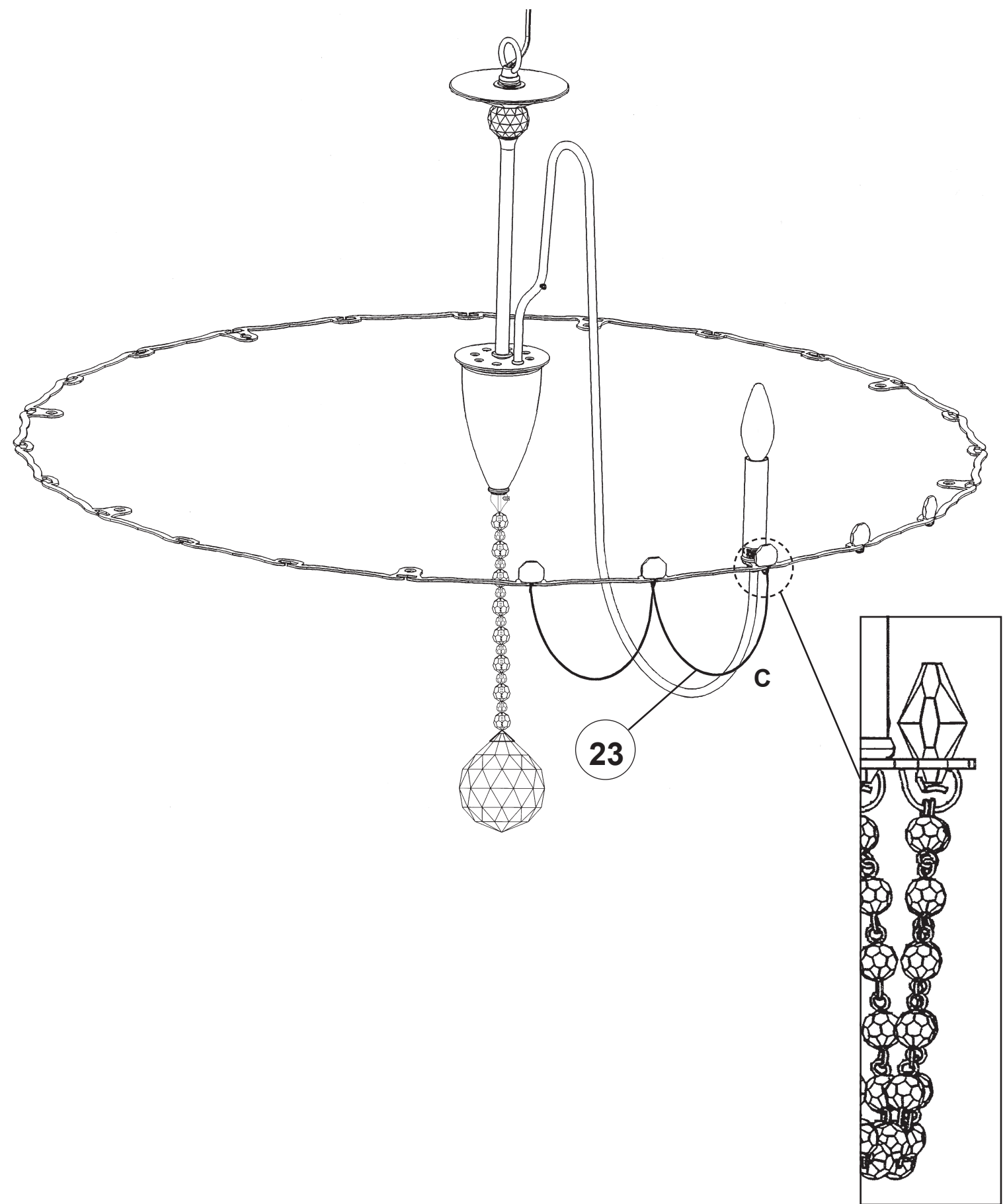
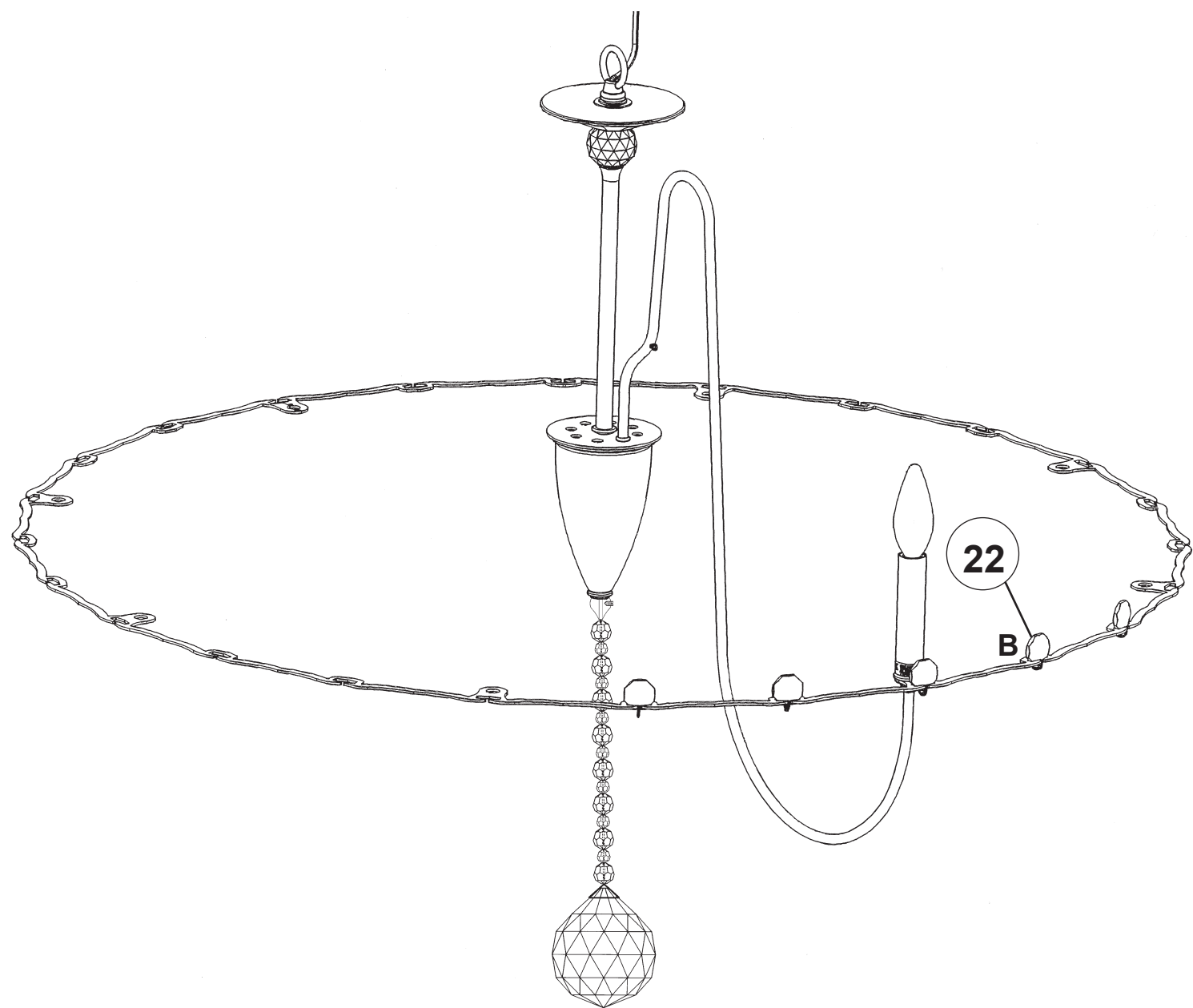

ESMERY AR1008N-__ __S

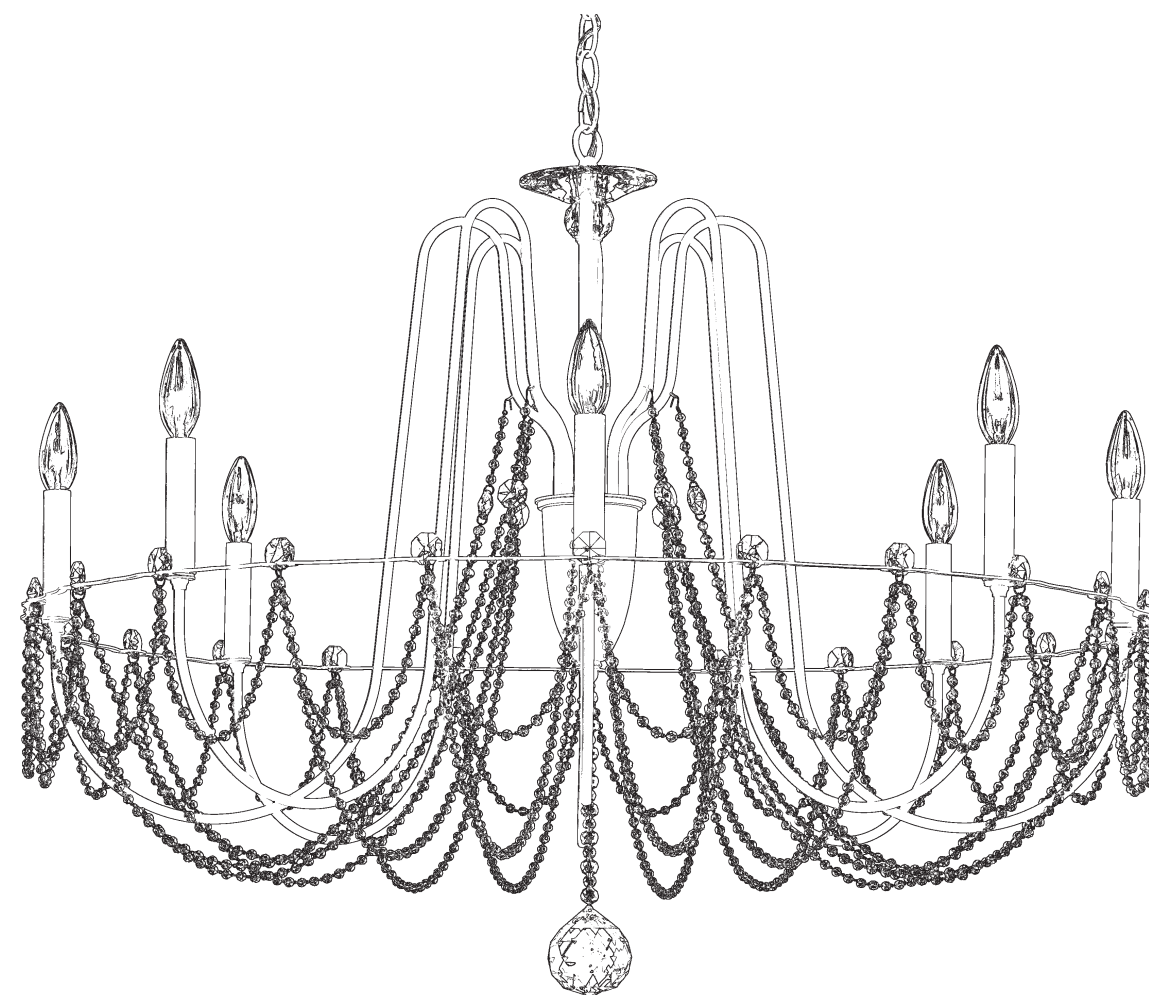











8 Lights
Diameter: 37"
Height: 28-1/2"
Hanging Weight: 13lbs.

THIS DESIGN IS THE PROPRIETARY
TRADE DRESS/TRADemark OF
W SCHONBEK LLC.

 **SCHONBEK** | 1870

 **SCHONBEK** | 1870

								
MAX 60 W		110-120 V						

WARNING:

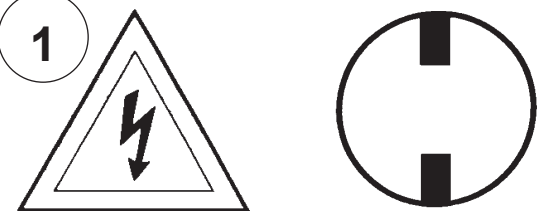
1 

Electrical Danger Turn Power Off

All electrical components must be installed by a licensed electrician in accordance with the National Electric Code and the appropriate local electrical codes.

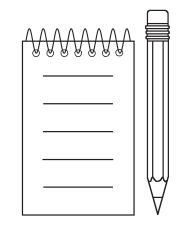
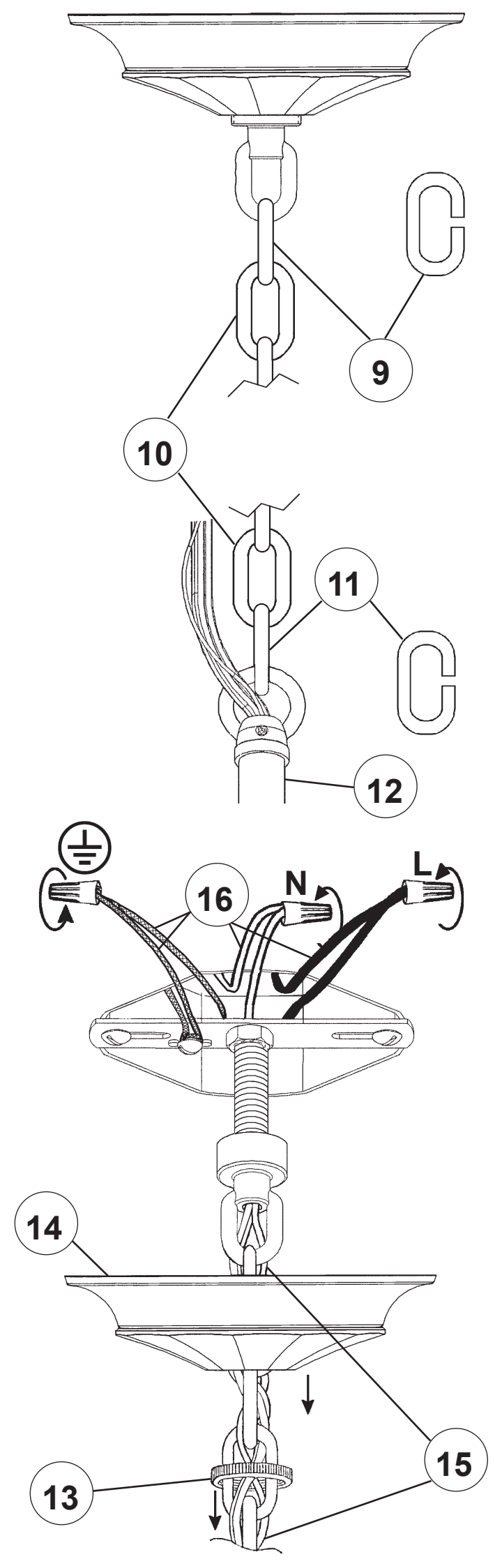
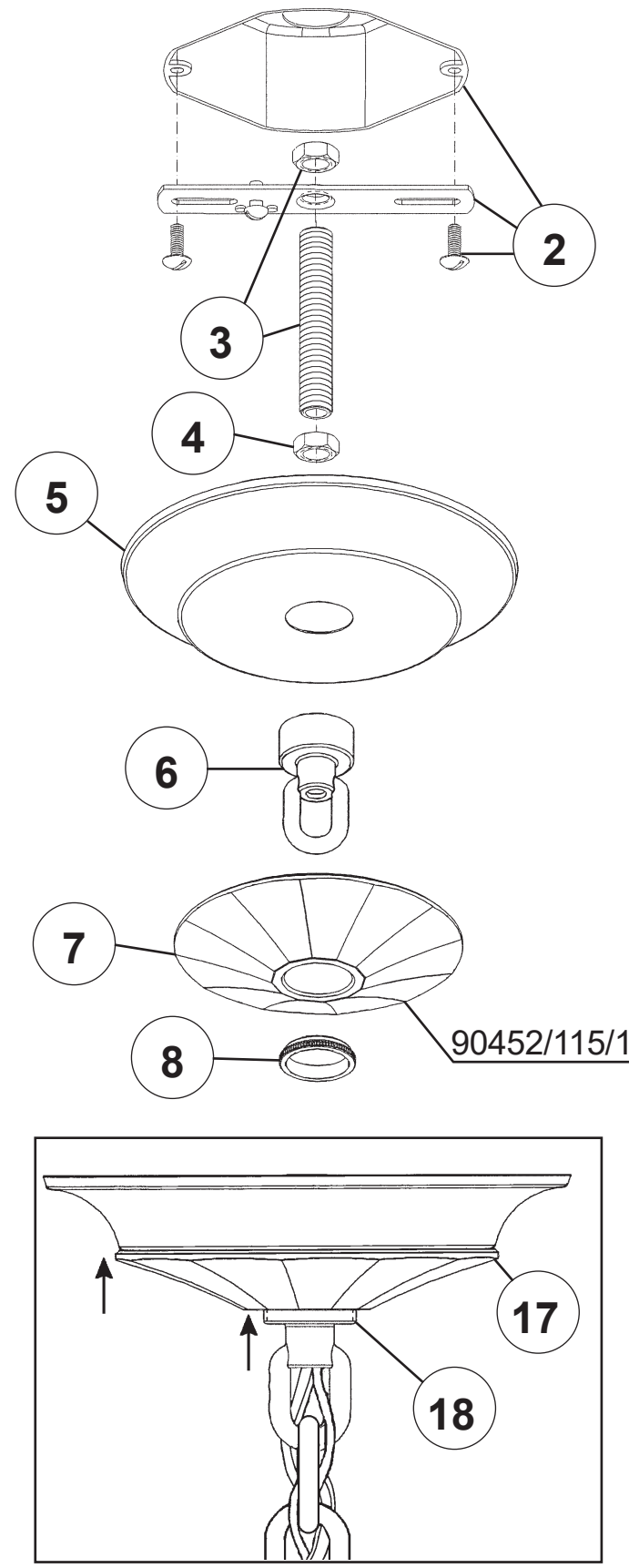

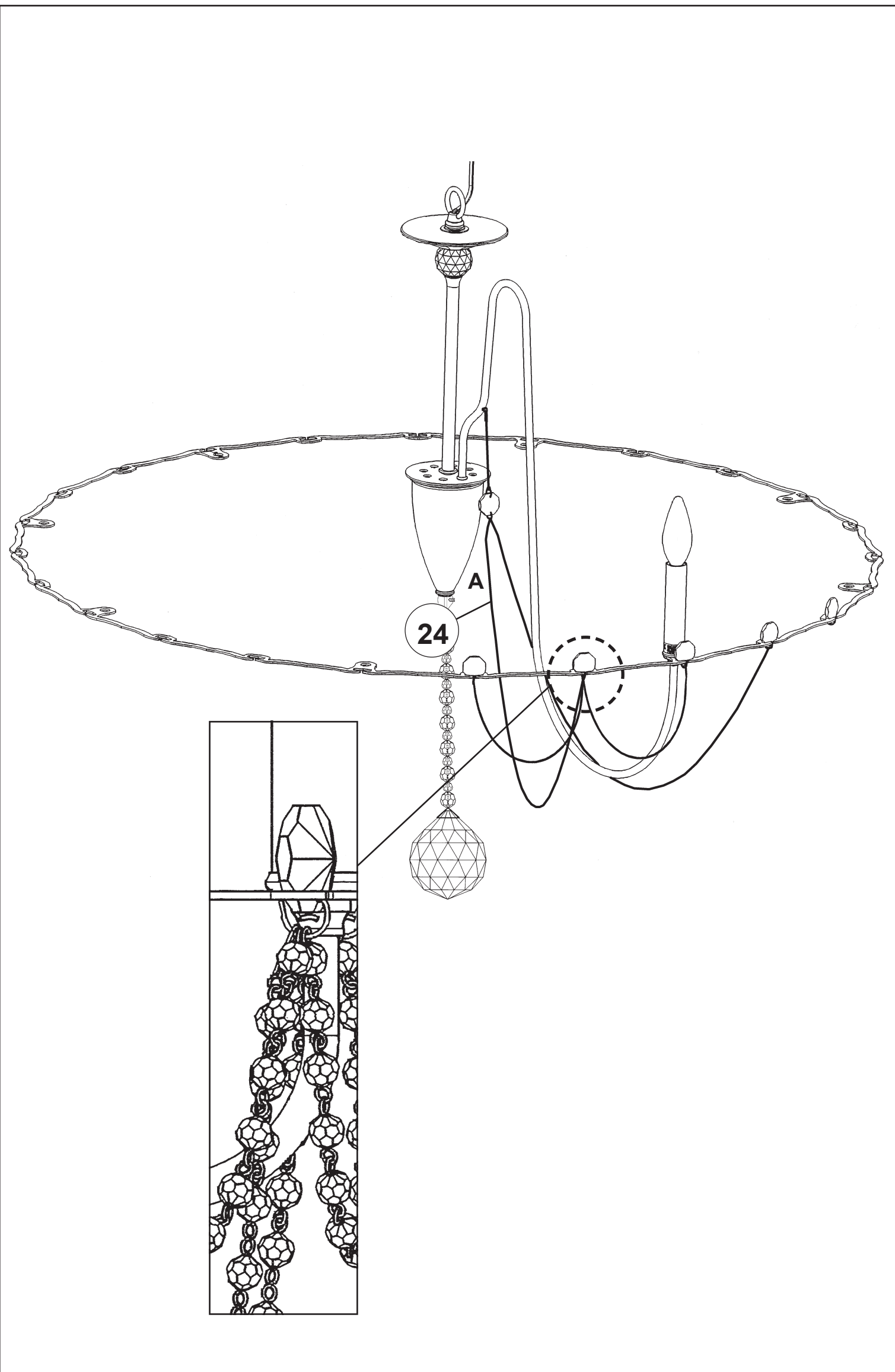

19

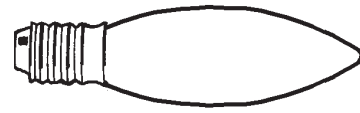

You will need 8 - B10
25 Watts Recommended
60 Watts Max

**Install bulbs and be sure
to test fixture BEFORE
trimming.**

