

ESMERY AR1012N-__ __O

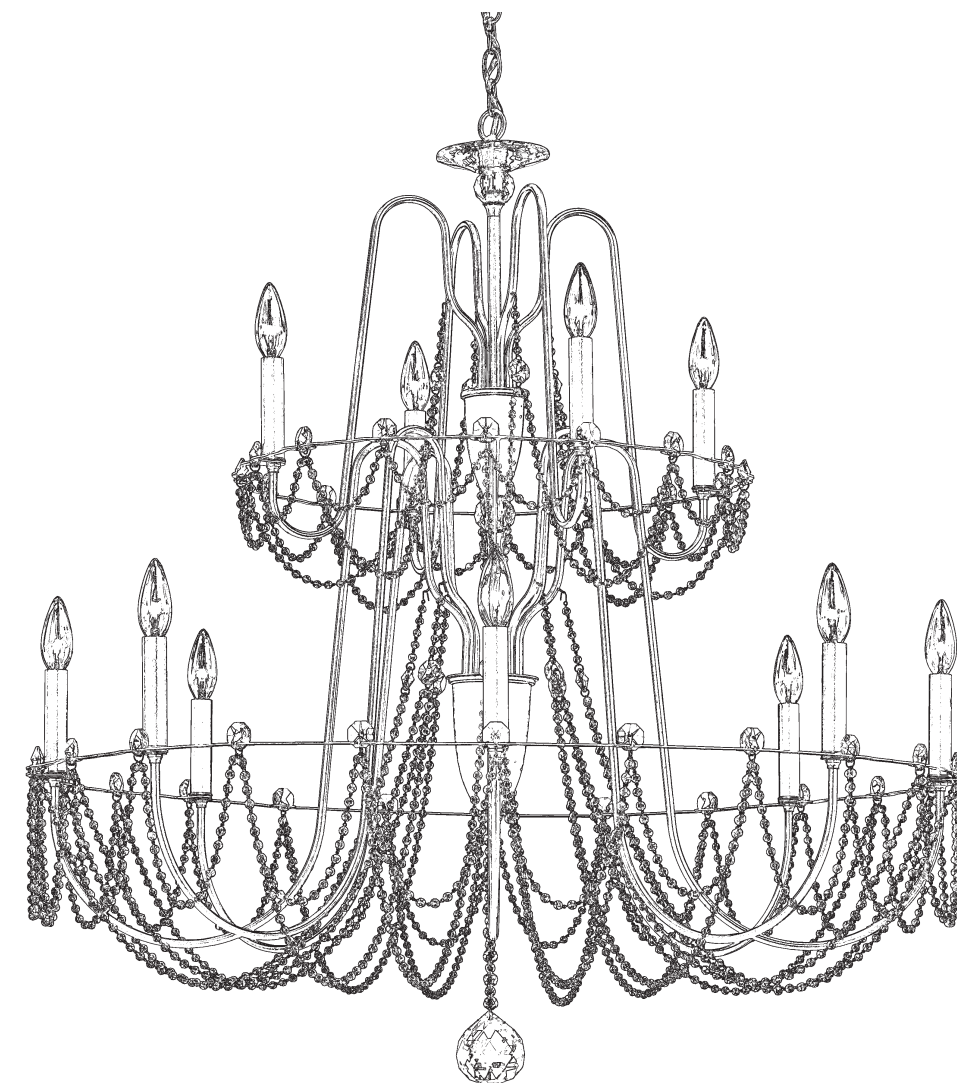











12 Lights
Diameter: 37"
Height: 39-1/2"
Hanging Weight: 17lbs.

THIS DESIGN IS THE PROPRIETARY
TRADE DRESS/TRADemark OF
W SCHONBEK LLC.

 **SCHONBEK** | 1870

 **SCHONBEK** | 1870

								
MAX <u>60</u> W		110-120 V						

WARNING:

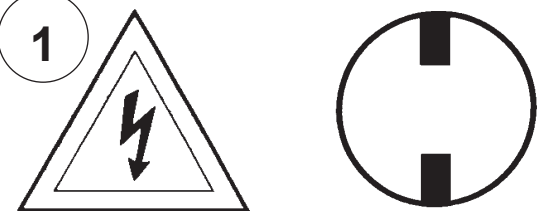
1 

Electrical Danger Turn Power Off

All electrical components must be installed by a licensed electrician in accordance with the National Electric Code and the appropriate local electrical codes.

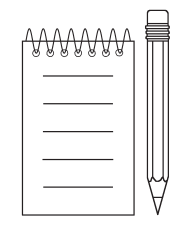
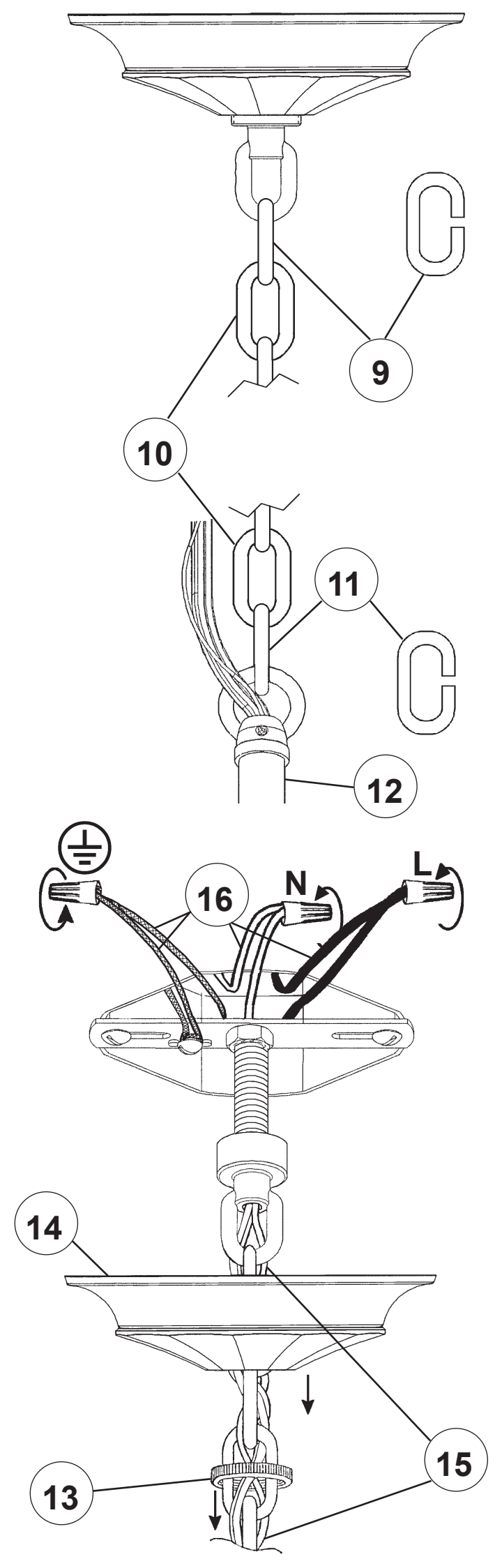
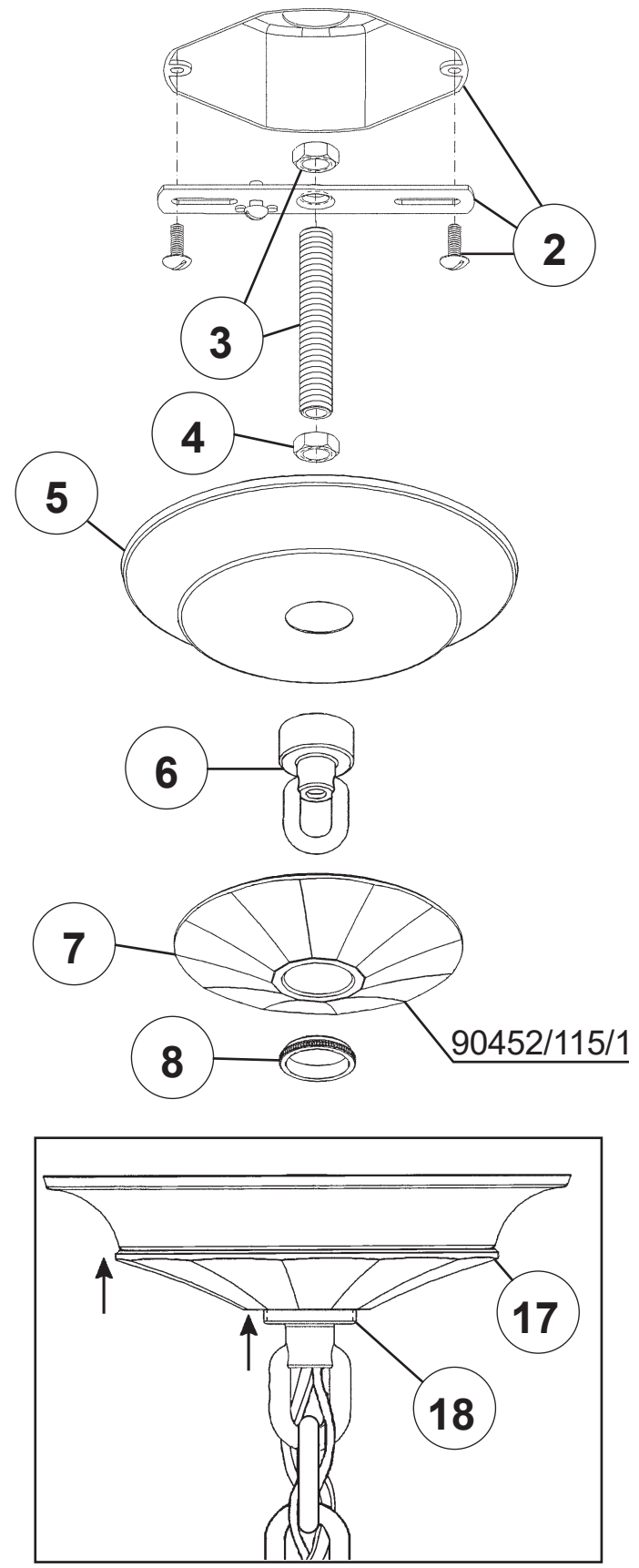

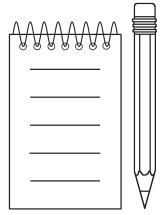

19

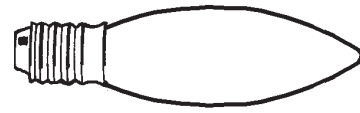

You will need 12 - B10
25 Watts Recommended
60 Watts Max

**Install bulbs and be sure
to test fixture BEFORE
trimming.**

90452/115

90016/40

90016/40

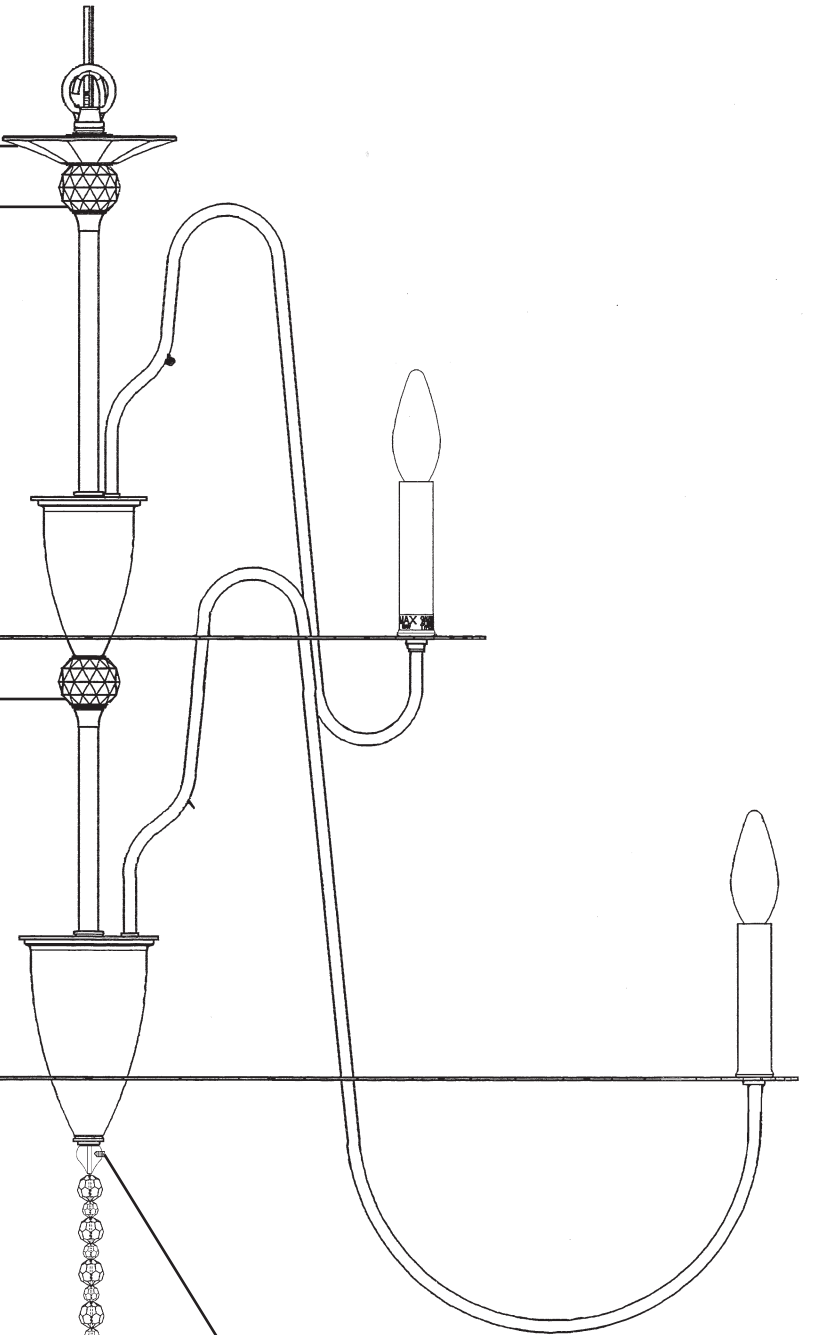

N19760-**

20

21

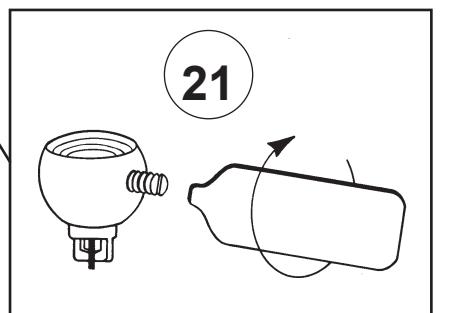

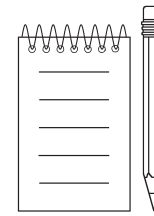
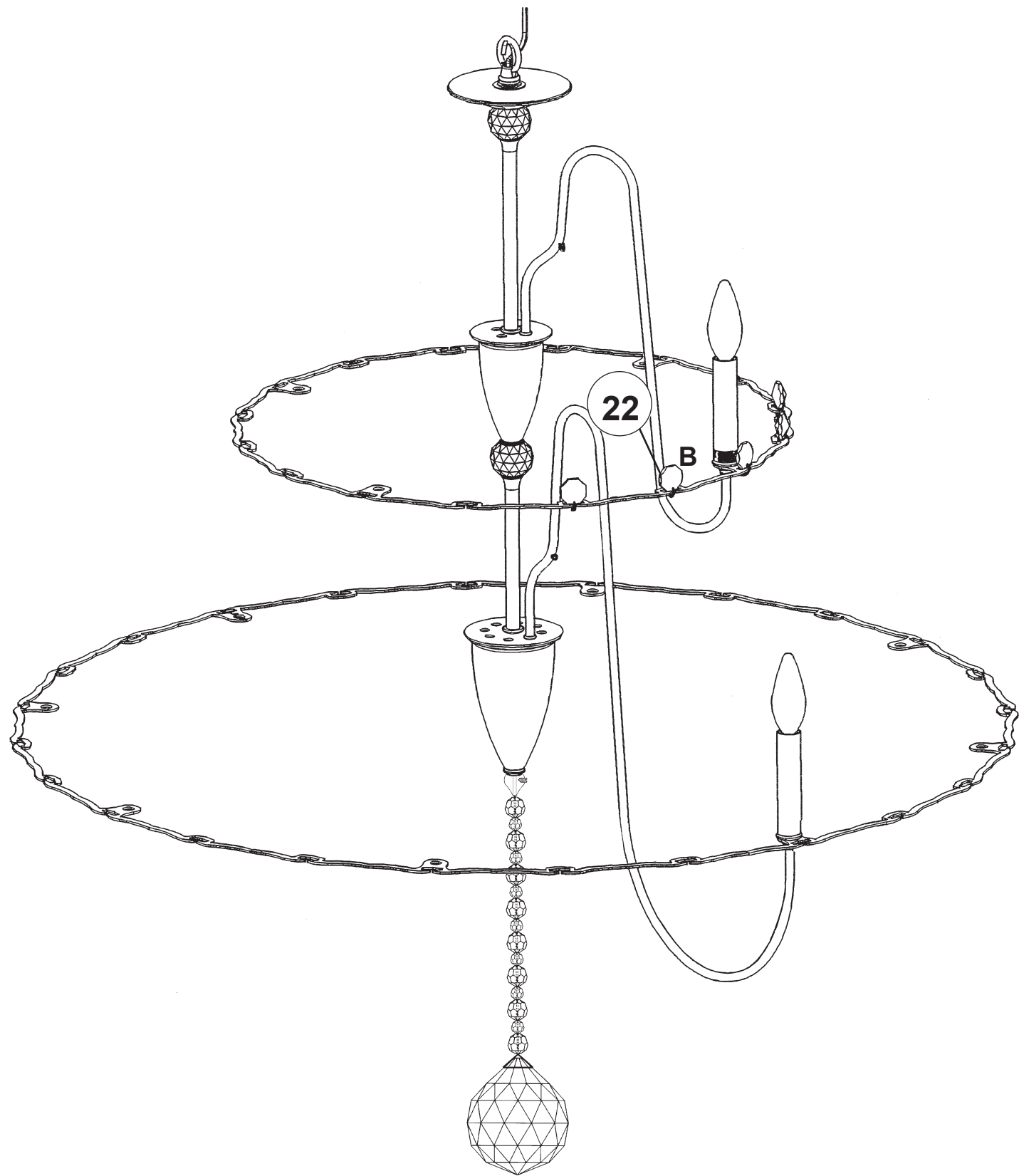

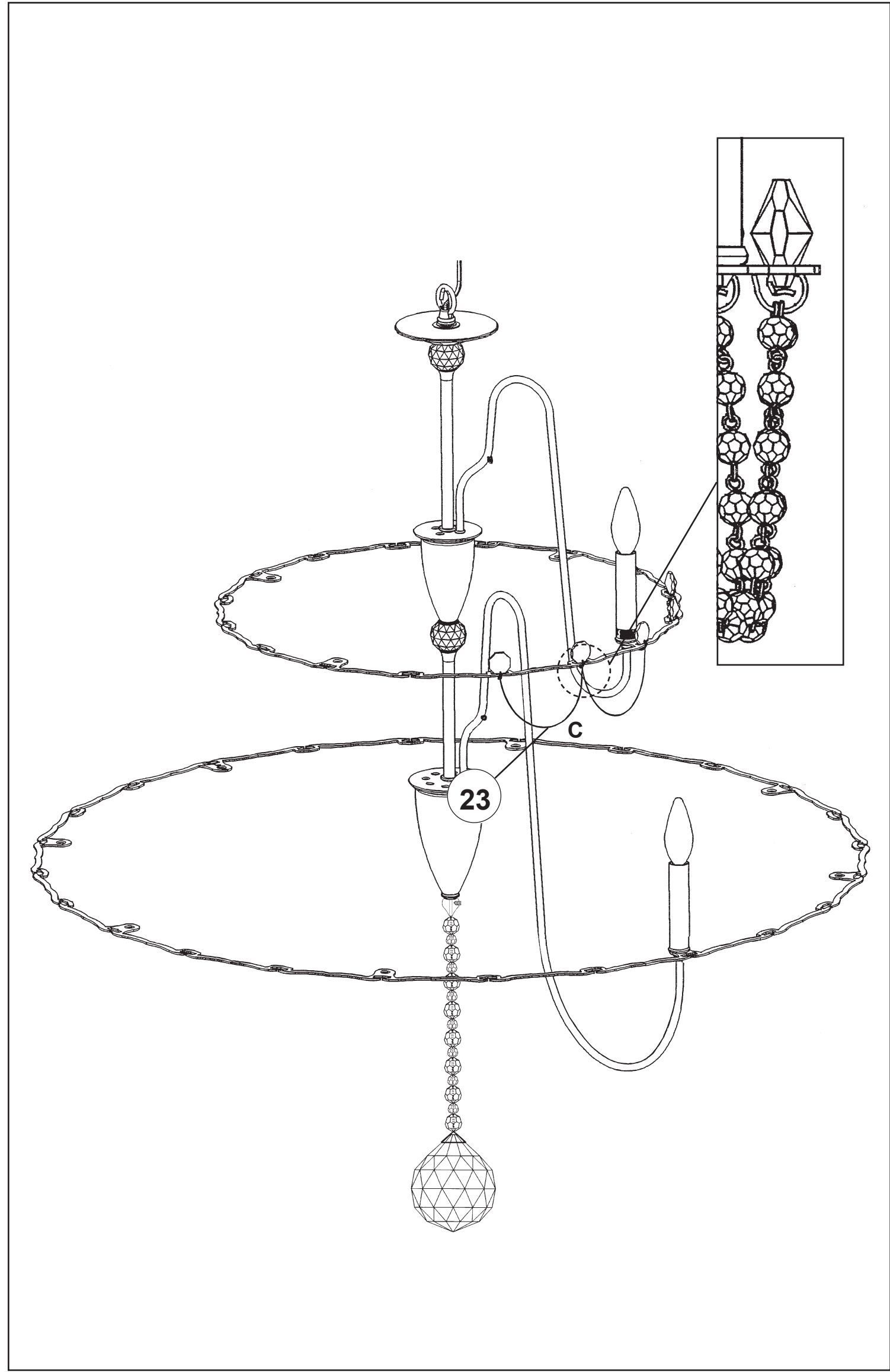
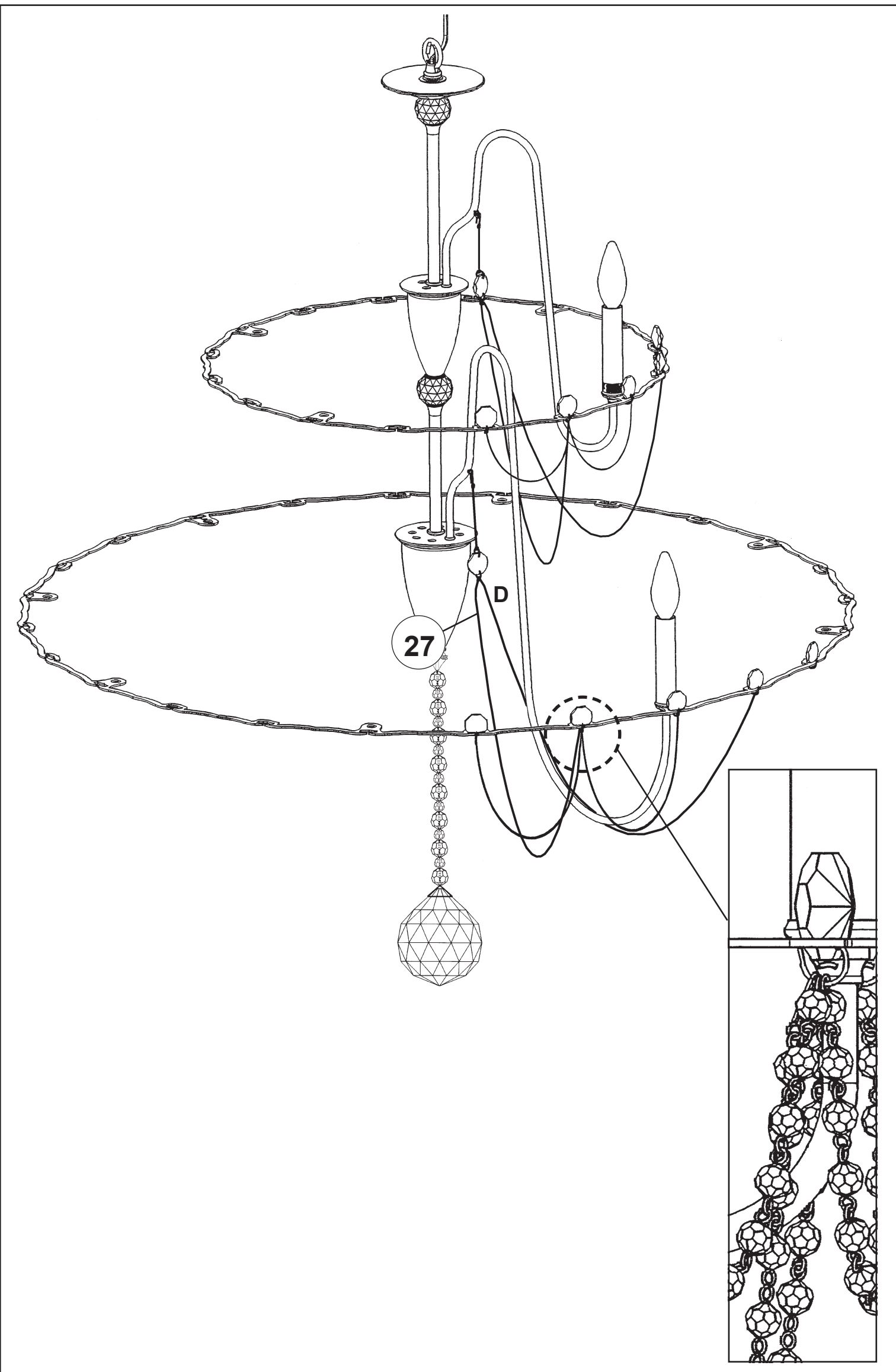

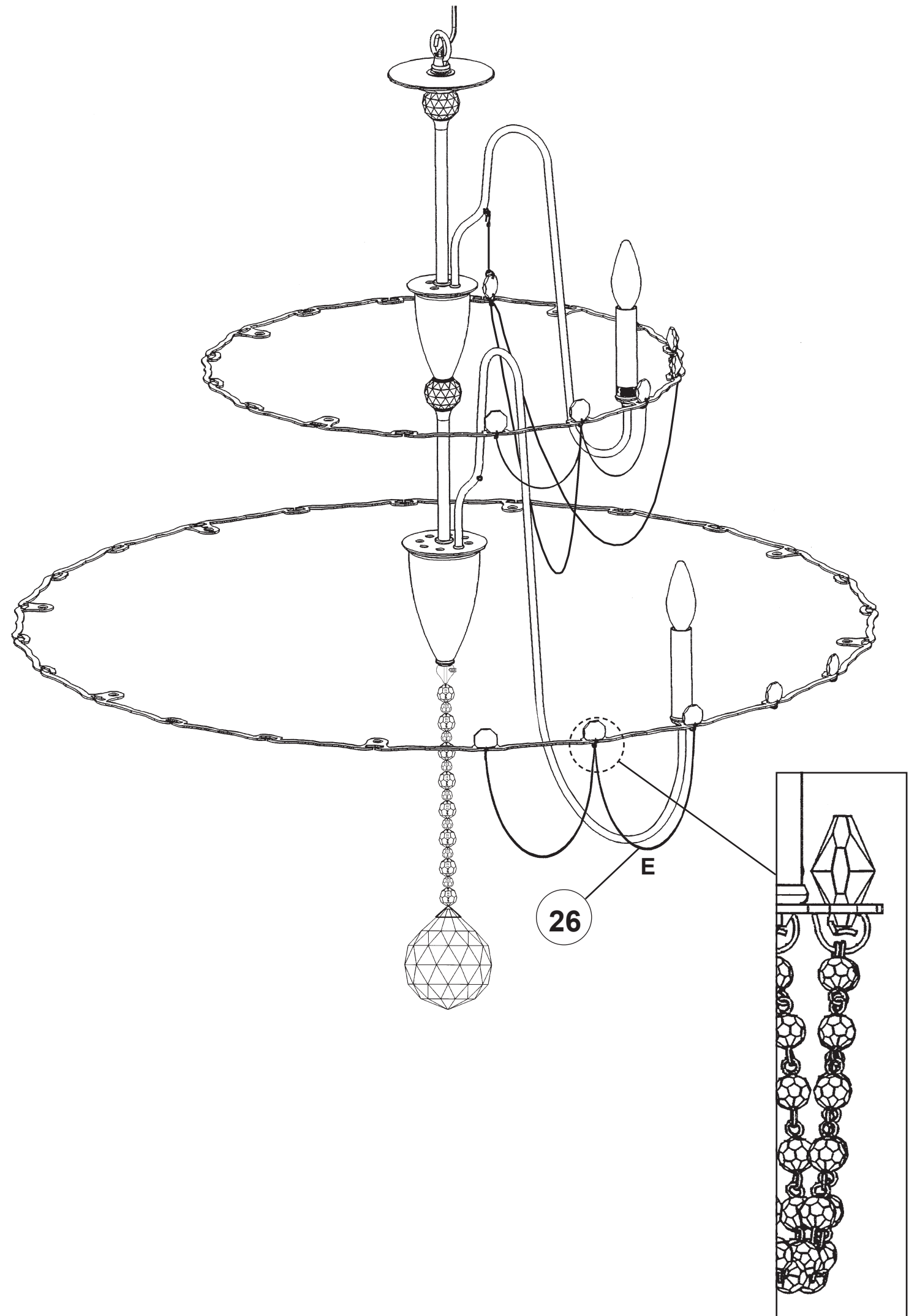
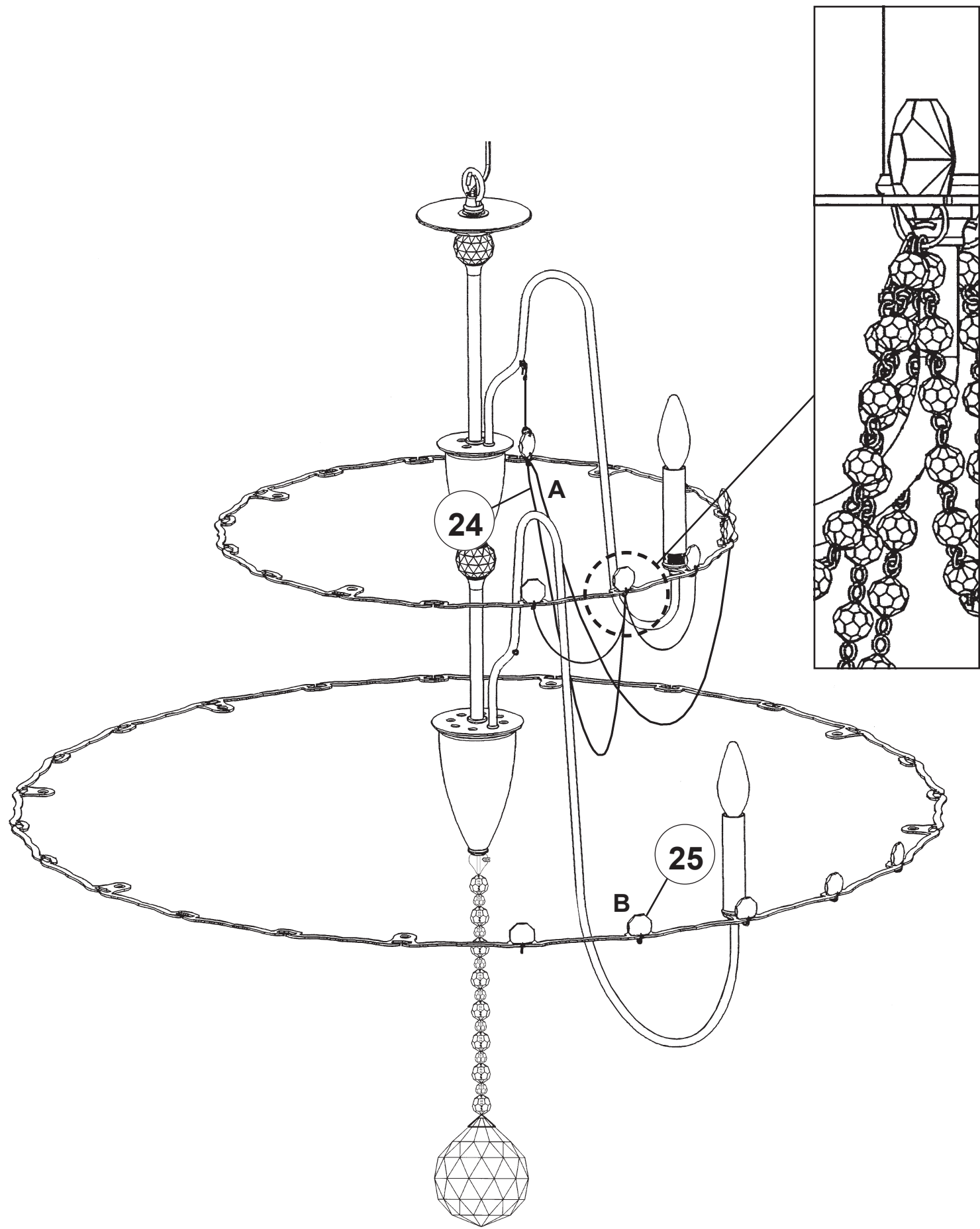

 **SCHONBEK** | 1870











ESMERY AR1012N-__ __S



THIS DESIGN IS THE PROPRIETARY TRADE DRESS/TRADemark OF W SCHONBEK LLC.

12 Lights
Diameter: 37"
Height: 39-1/2"
Hanging Weight: 17lbs.

 **SCHONBEK** | 1870

								
MAX 60 W	110-120 V							

WARNING:

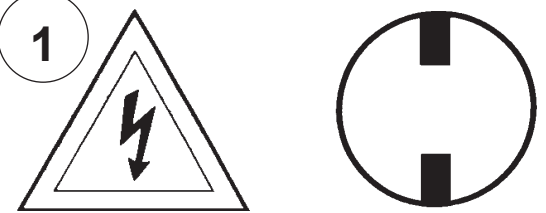
1 

Electrical Danger Turn Power Off

All electrical components must be installed by a licensed electrician in accordance with the National Electric Code and the appropriate local electrical codes.

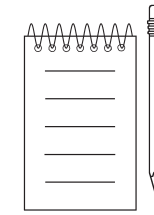
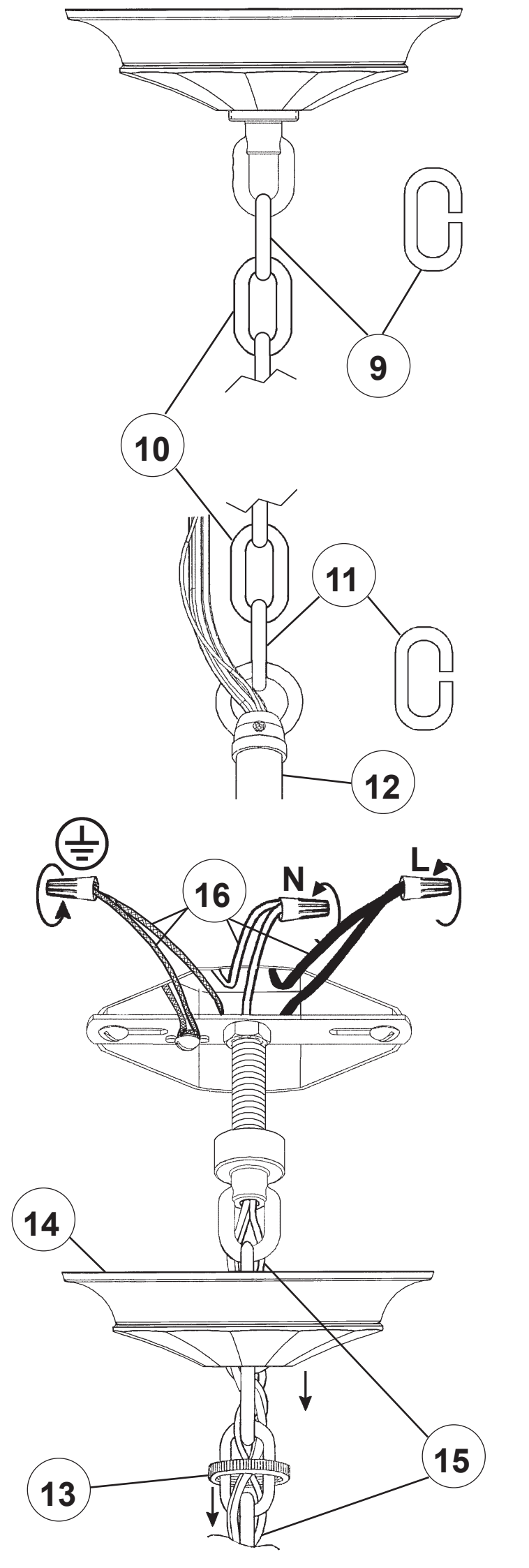
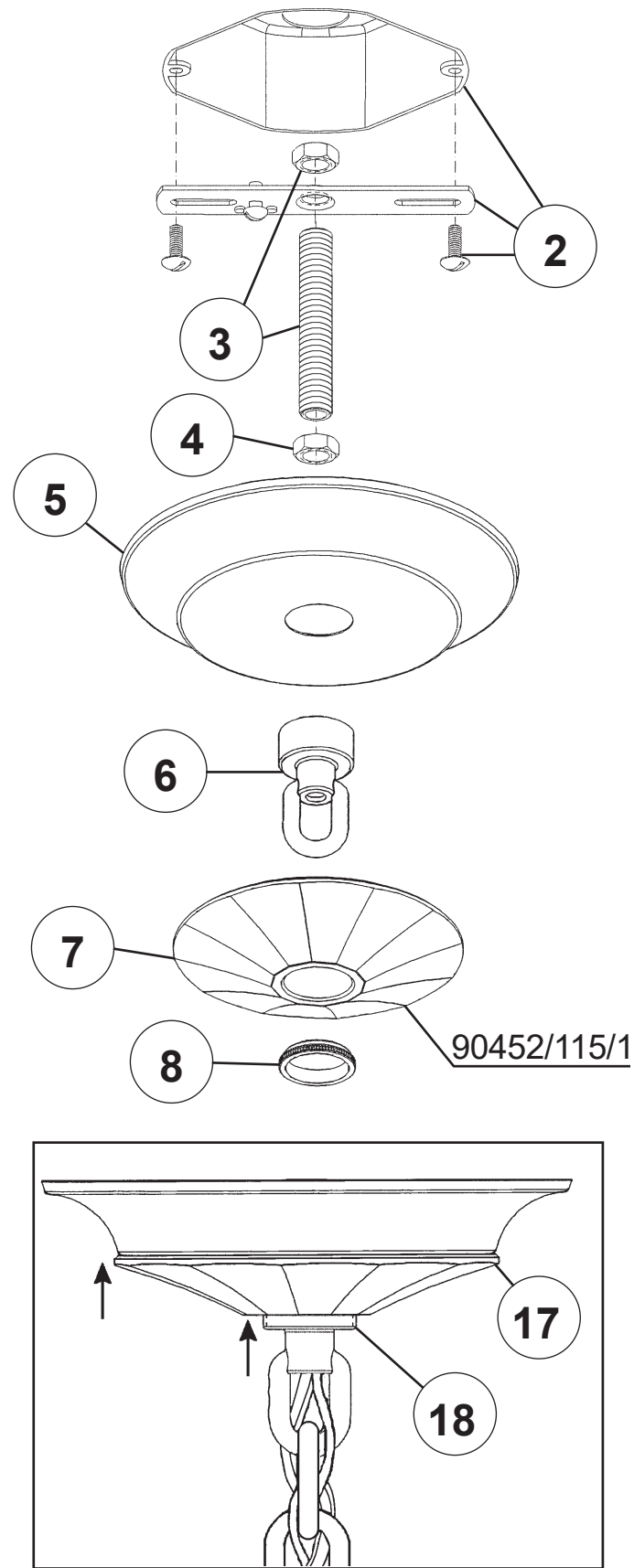

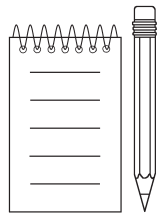

19

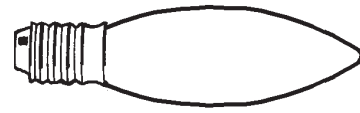

You will need 12 - B10
25 Watts Recommended
60 Watts Max

**Install bulbs and be sure
to test fixture BEFORE
trimming.**

90452/115

90016/40

90016/40

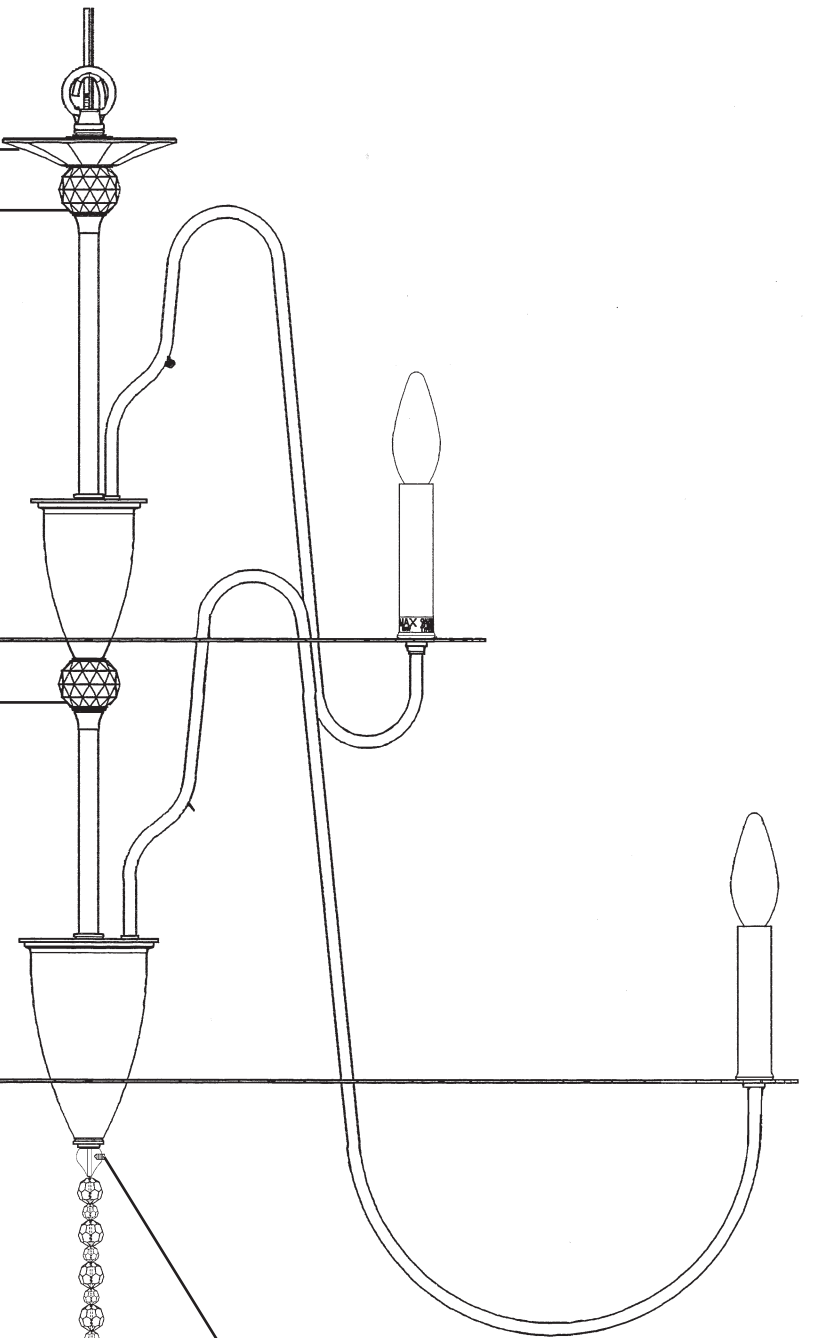

N19763-**

20

21

