

PRISCILLA BC7105N-__ __O

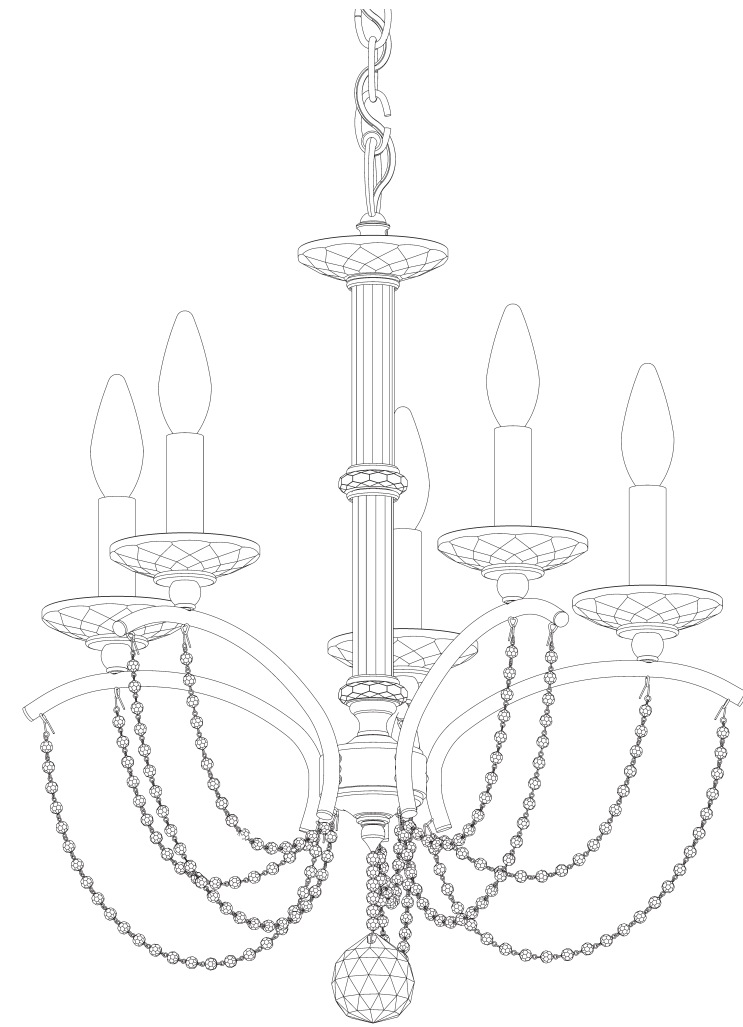











5 Lights
Diameter: 18"
Height: 22"
Hanging Weight: 6lbs.

THIS DESIGN IS THE PROPRIETARY
TRADE DRESS/TRADEMARK OF
W SCHONBEK LLC.

 **SCHONBEK** | 1870

 **SCHONBEK** | 1870

								
MAX <u>60</u> W	110-120 V							

WARNING:

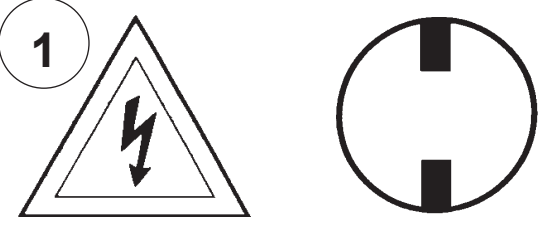
1 

Electrical Danger Turn Power Off

All electrical components must be installed by a licensed electrician in accordance with the National Electric Code and the appropriate local electrical codes.

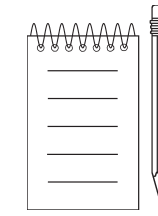
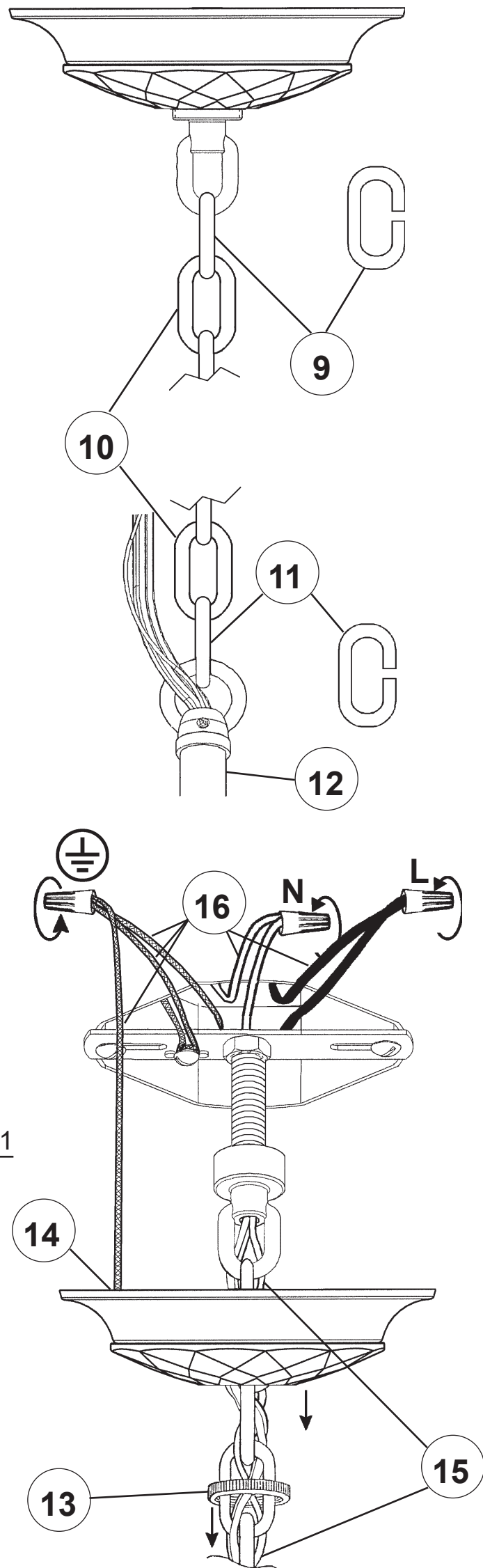
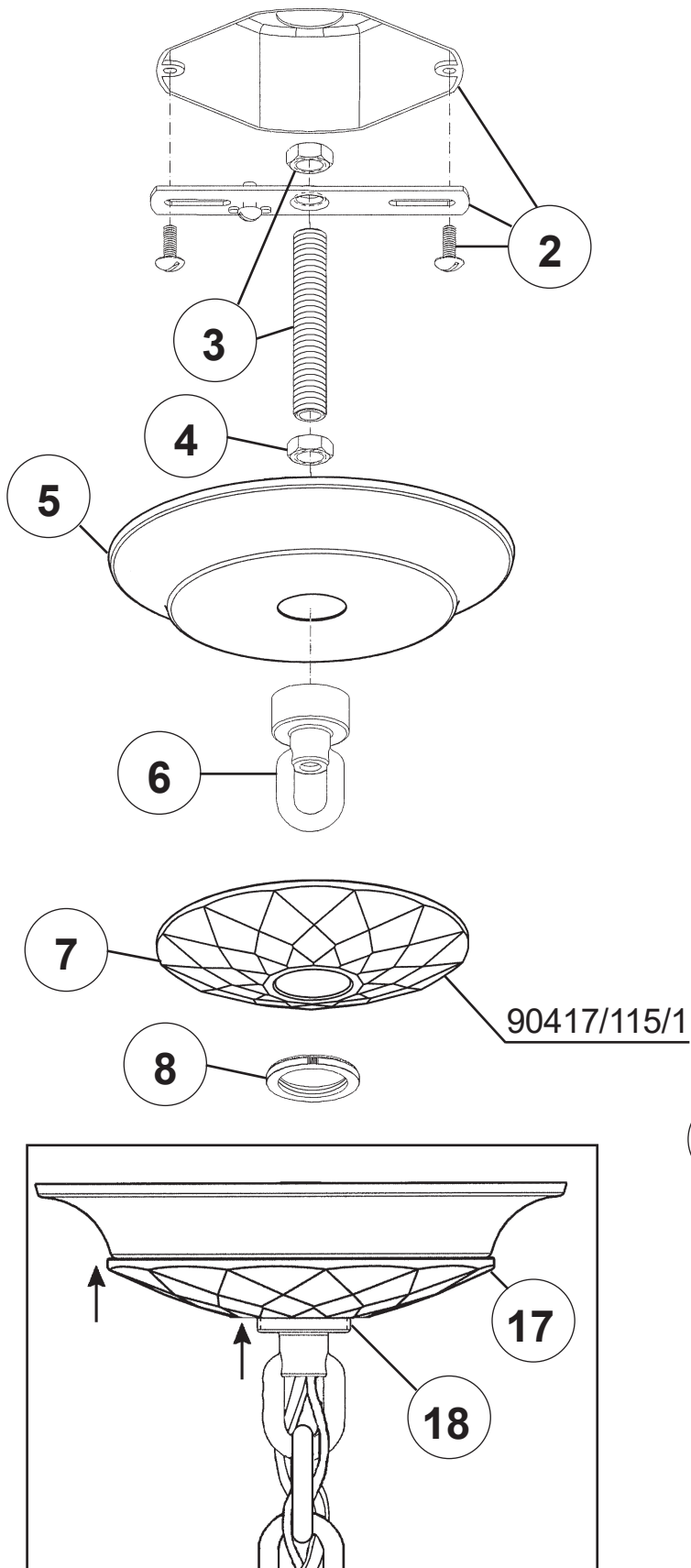

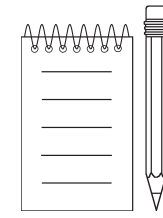
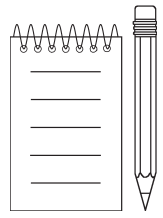

19



You will need 5 - B10
60 Watts Max

Install bulbs and be sure to
test fixture BEFORE
trimming.

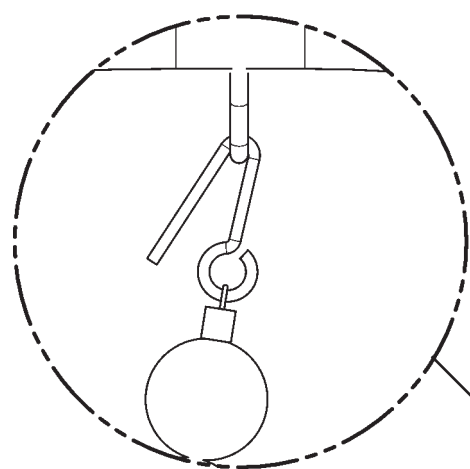

21

A

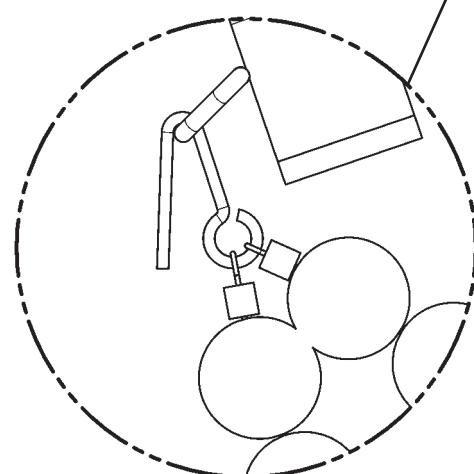

N20874-**

20

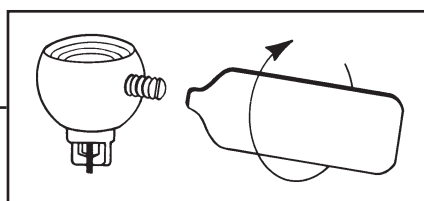

90417/090

90303/0114

90126/40

90303/0114

90126/40

90417/090



PRISCILLA BC7105N- __ __ P __ __

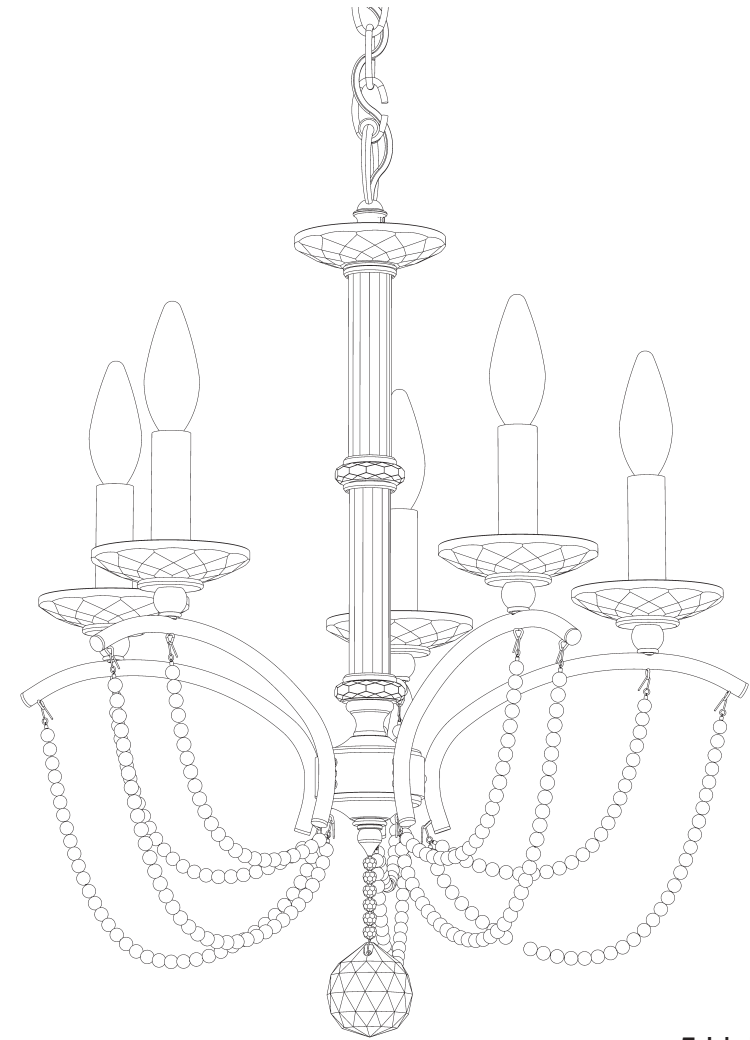











5 Lights
Diameter: 18"
Height: 22"
Hanging Weight: 6lbs.

THIS DESIGN IS THE PROPRIETARY
TRADE DRESS/TRADEMARK OF
W SCHONBEK LLC.

 **SCHONBEK** | 1870

 **SCHONBEK** | 1870

								
MAX <u>60</u> W	110-120 V							

WARNING:

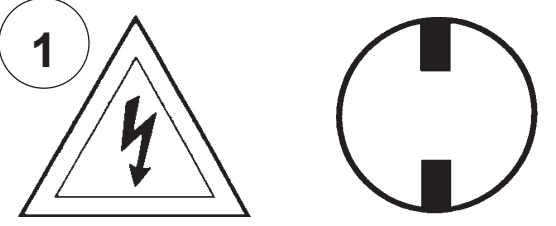
1 

Electrical Danger Turn Power Off

All electrical components must be installed by a licensed electrician in accordance with the National Electric Code and the appropriate local electrical codes.

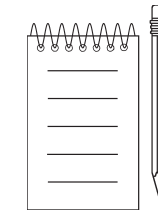
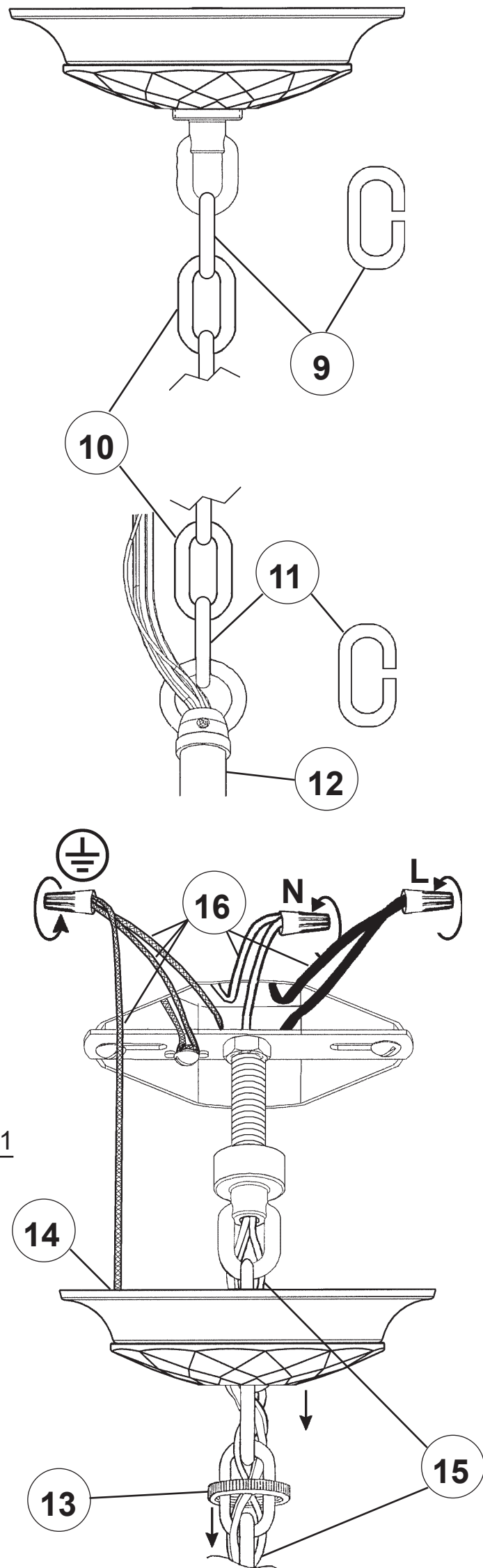
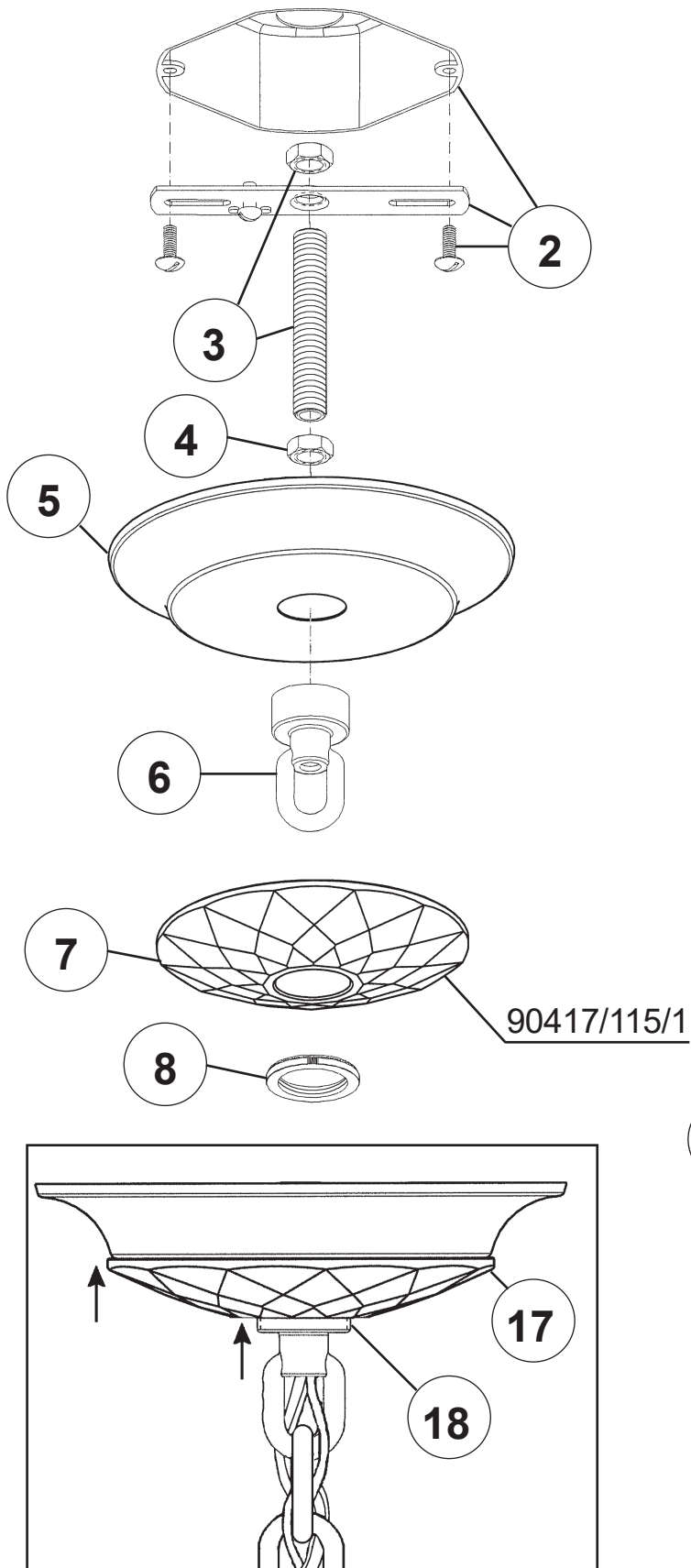

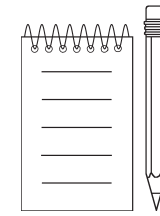
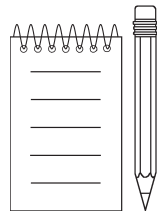

19

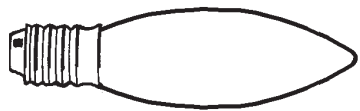

You will need 5 - B10
60 Watts Max

Install bulbs and be sure to
test fixture **BEFORE**
trimming.

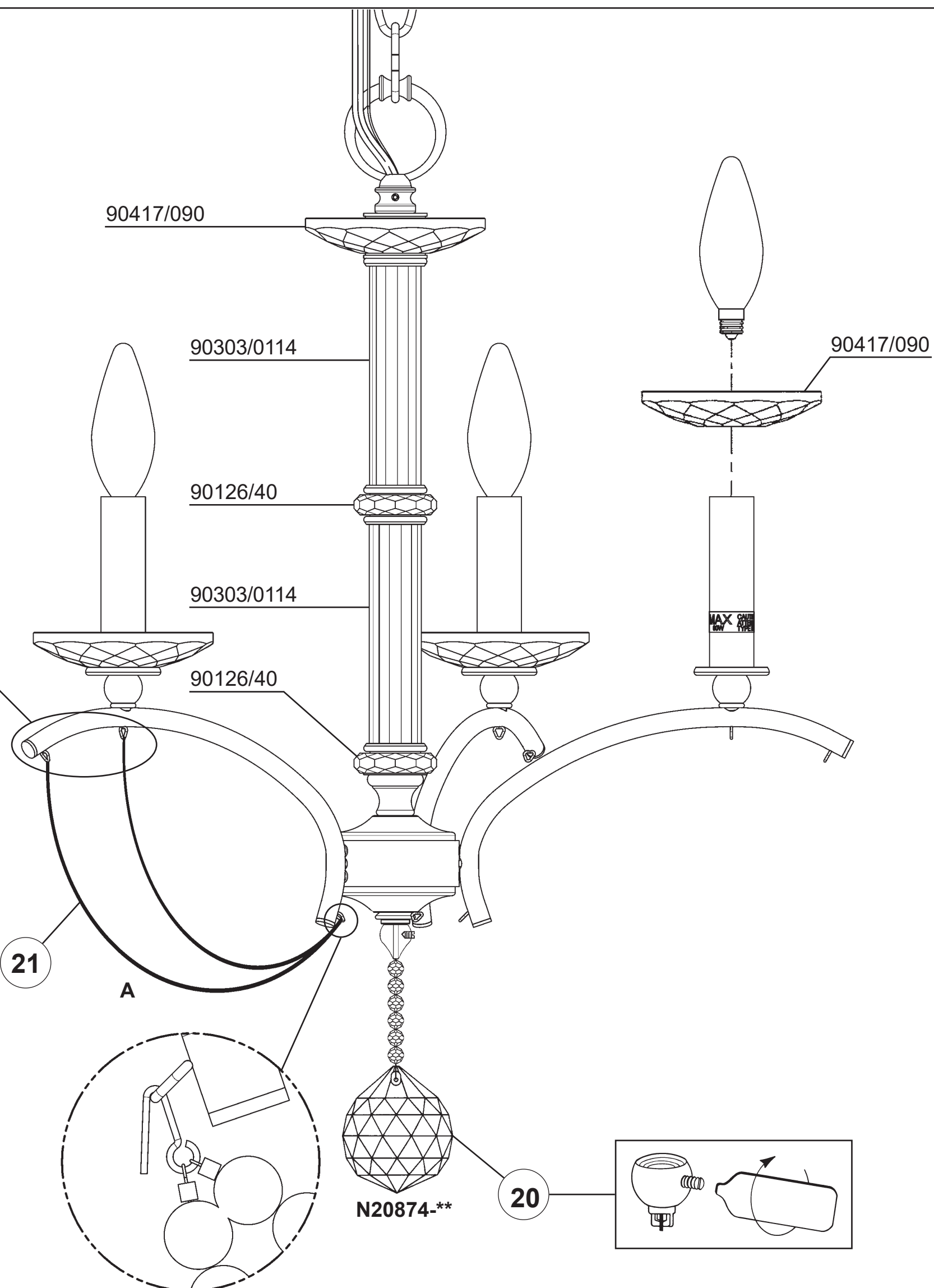
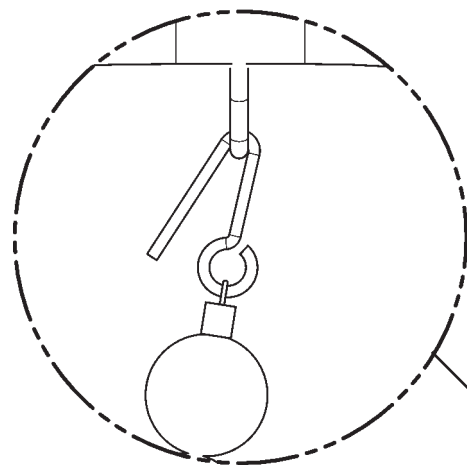

21

A

N20874-**

20



PRISCILLA BC7105N- __ __ P __ __

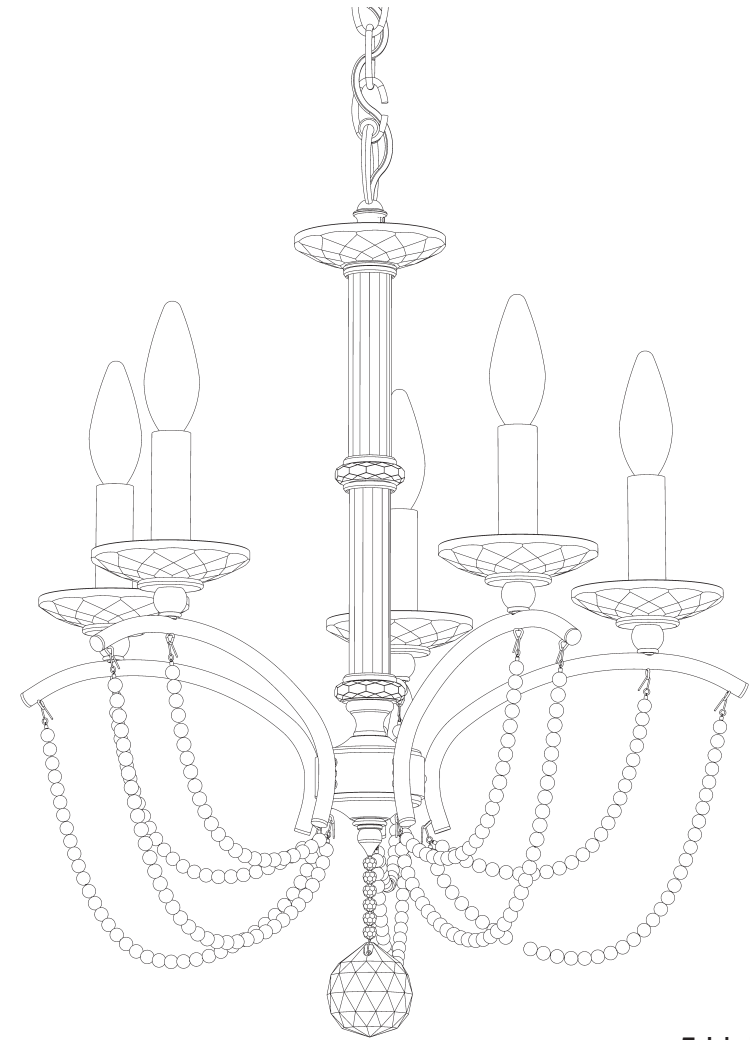











5 Lights
Diameter: 18"
Height: 22"
Hanging Weight: 6lbs.

THIS DESIGN IS THE PROPRIETARY
TRADE DRESS/TRADEMARK OF
W SCHONBEK LLC.

 **SCHONBEK** | 1870

 **SCHONBEK** | 1870

								
MAX <u>60</u> W	110-120 V							

WARNING:

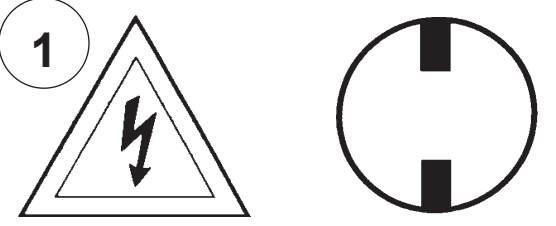
1 

Electrical Danger Turn Power Off

All electrical components must be installed by a licensed electrician in accordance with the National Electric Code and the appropriate local electrical codes.

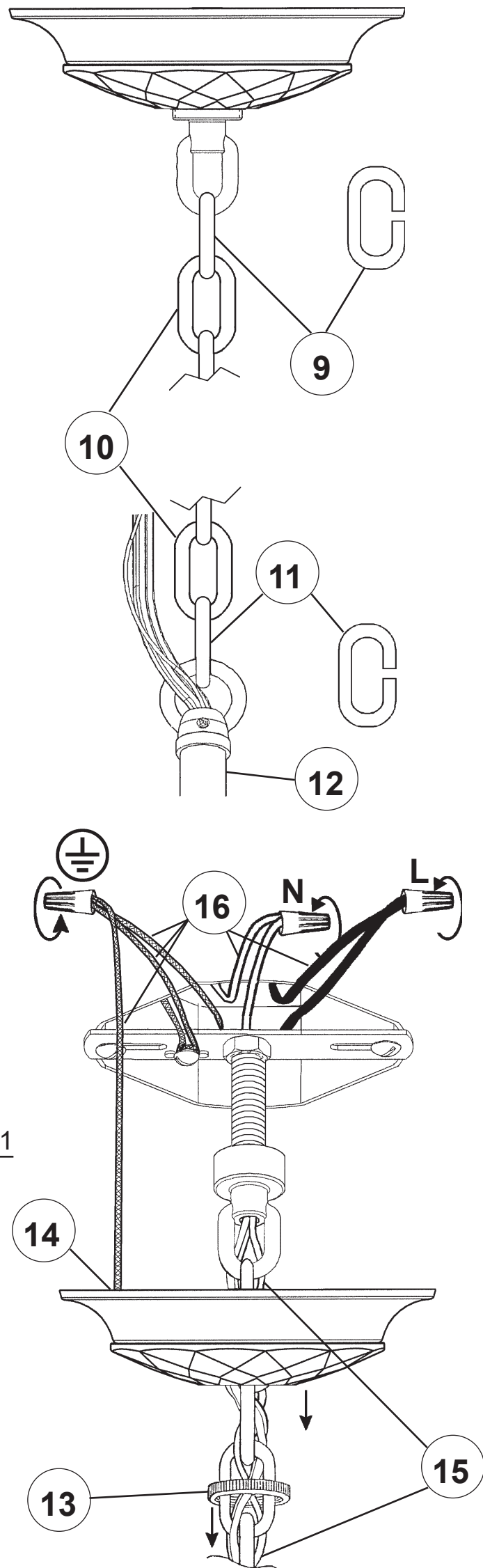
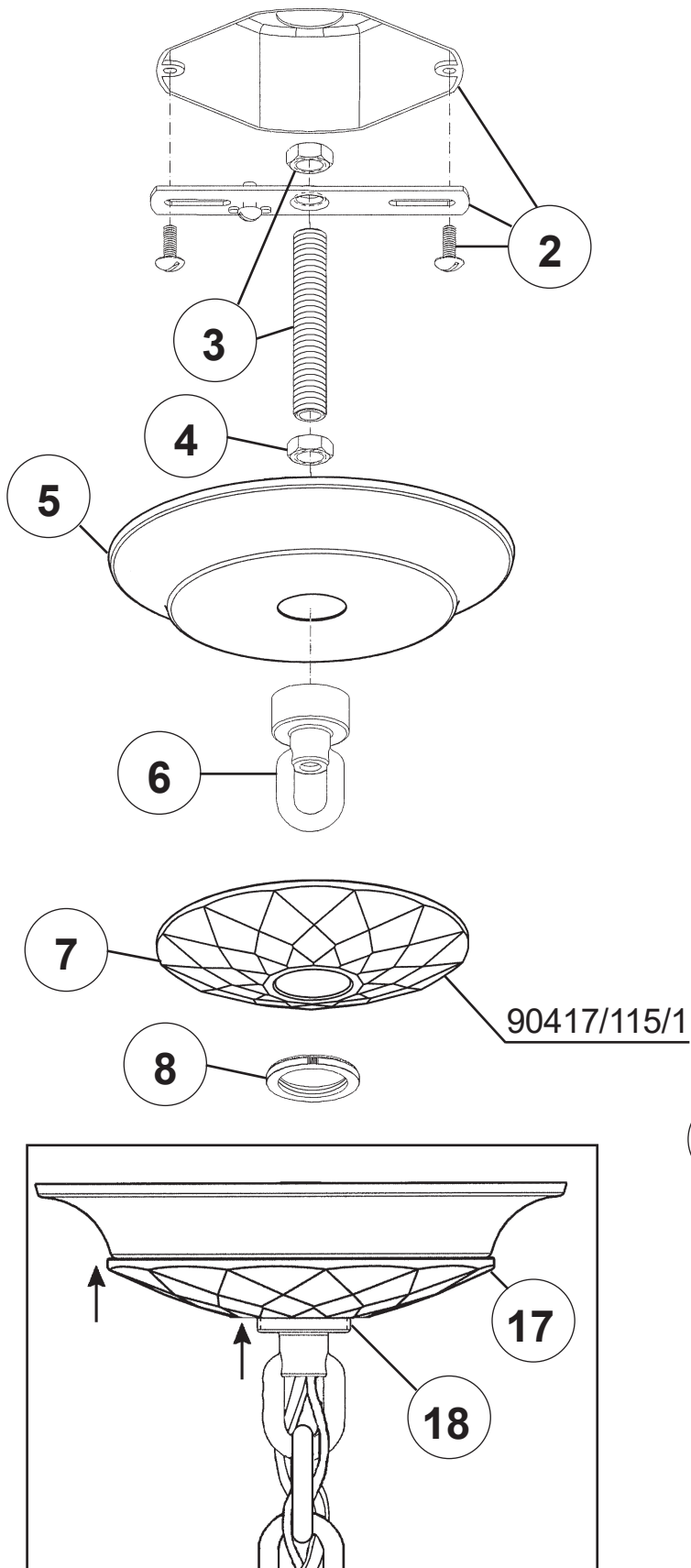

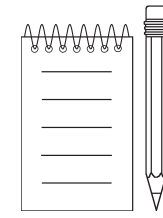
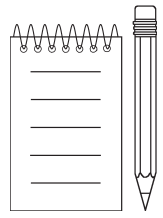

19



You will need 5 - B10
60 Watts Max

Install bulbs and be sure to
test fixture **BEFORE**
trimming.

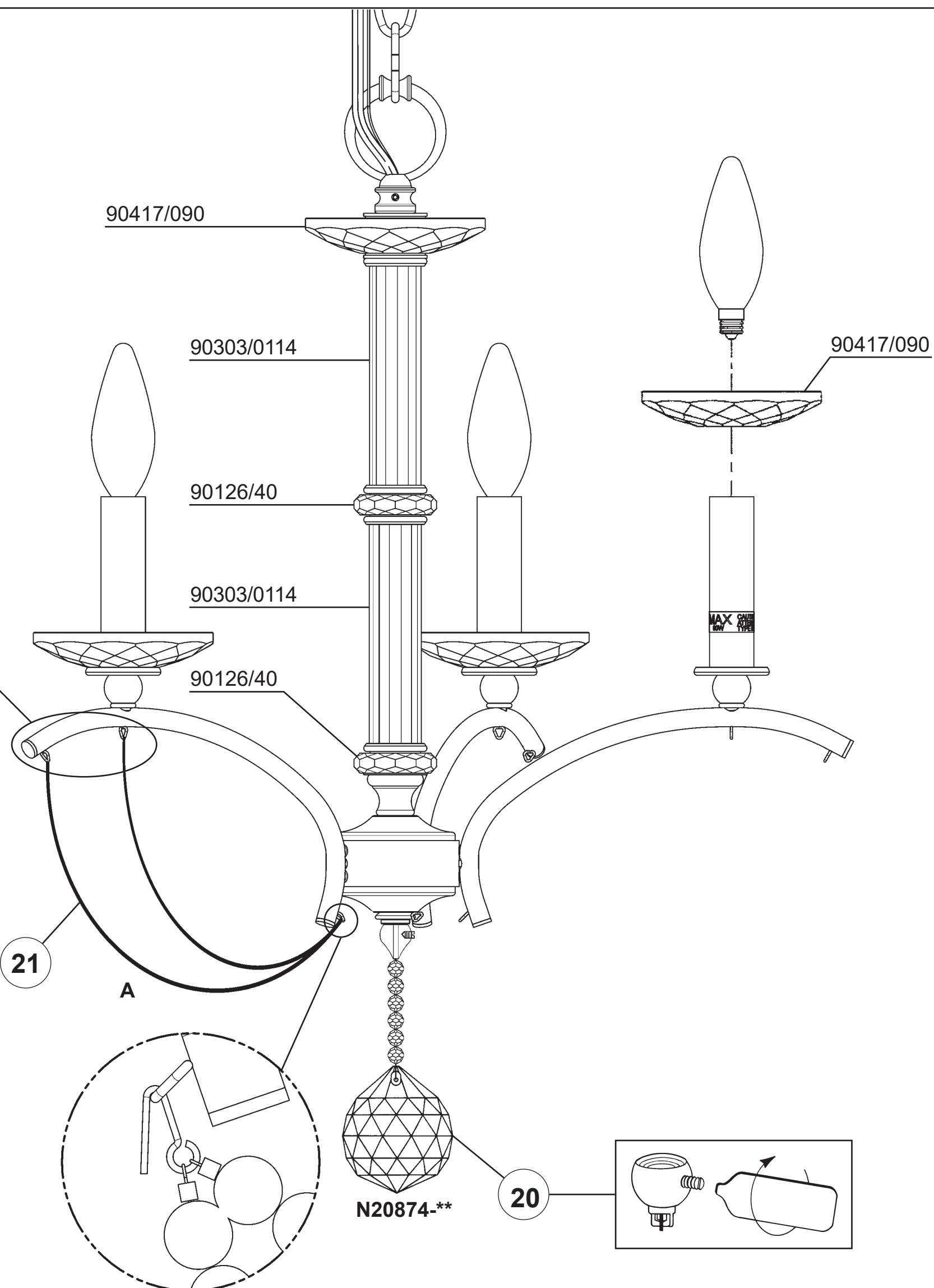
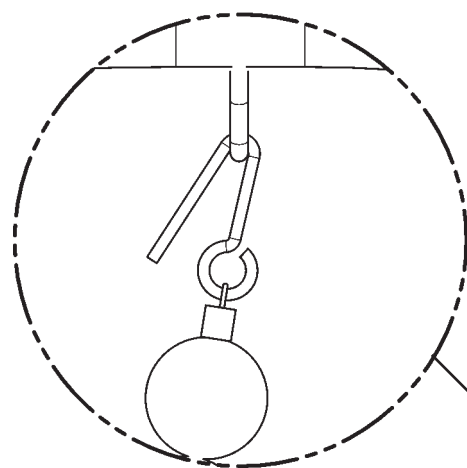

21

A

N20874-**

20

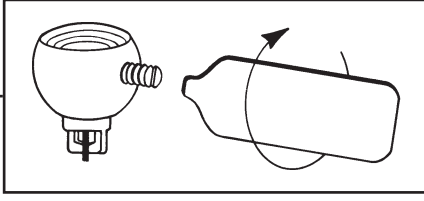

PRISCILLA BC7105N- __ __ P __ __

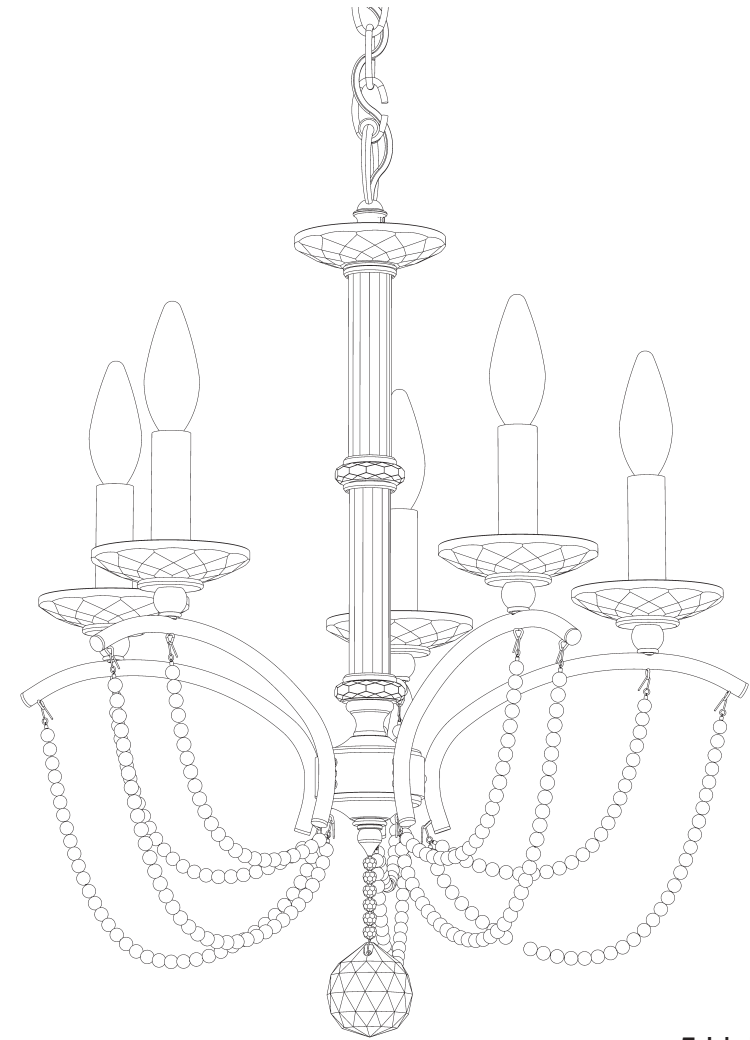











5 Lights
Diameter: 18"
Height: 22"
Hanging Weight: 6lbs.

THIS DESIGN IS THE PROPRIETARY
TRADE DRESS/TRADEMARK OF
W SCHONBEK LLC.

 **SCHONBEK** | 1870

 **SCHONBEK** | 1870

								
MAX <u>60</u> W	110-120 V							

WARNING:

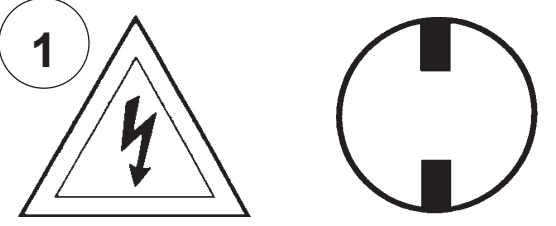
1 

Electrical Danger Turn Power Off

All electrical components must be installed by a licensed electrician in accordance with the National Electric Code and the appropriate local electrical codes.

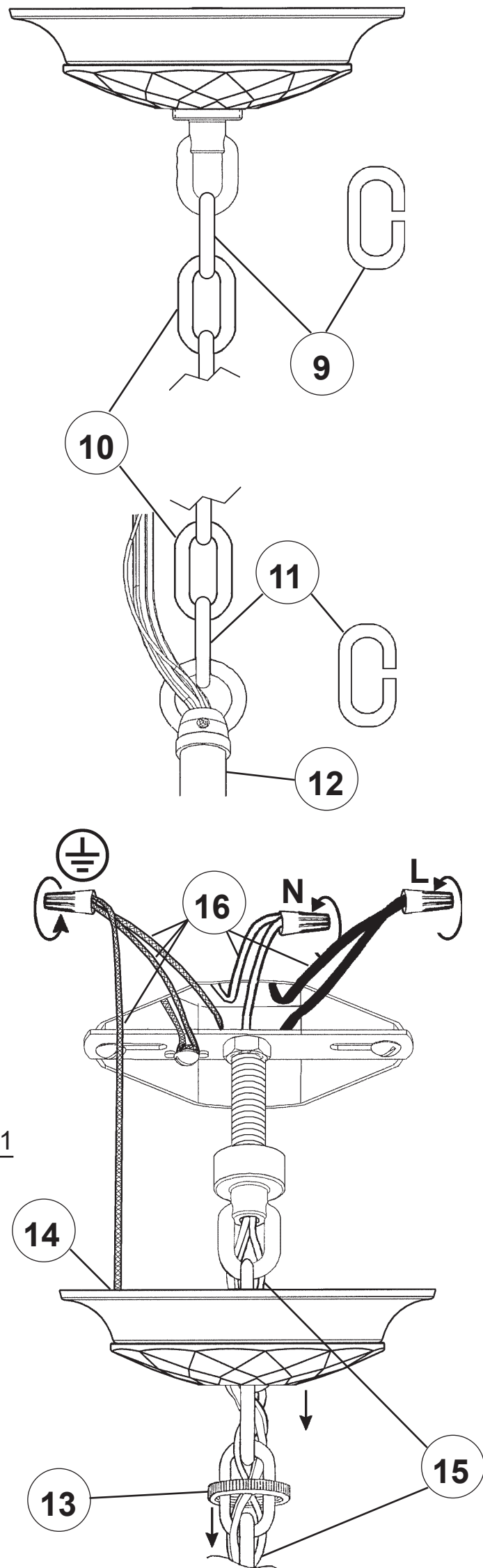
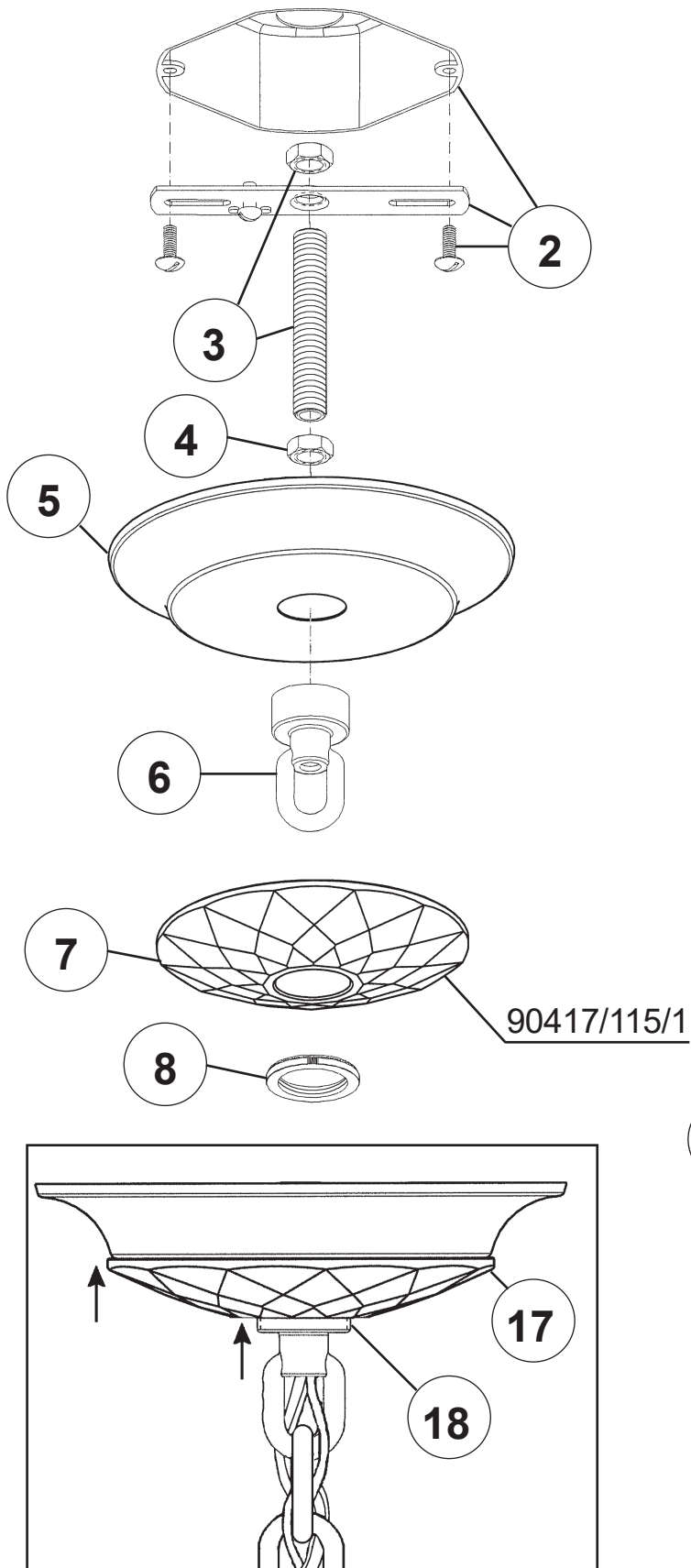

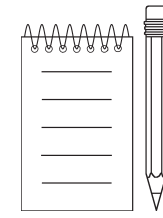
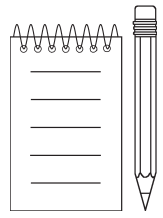

19



You will need 5 - B10
60 Watts Max

Install bulbs and be sure to
test fixture **BEFORE**
trimming.

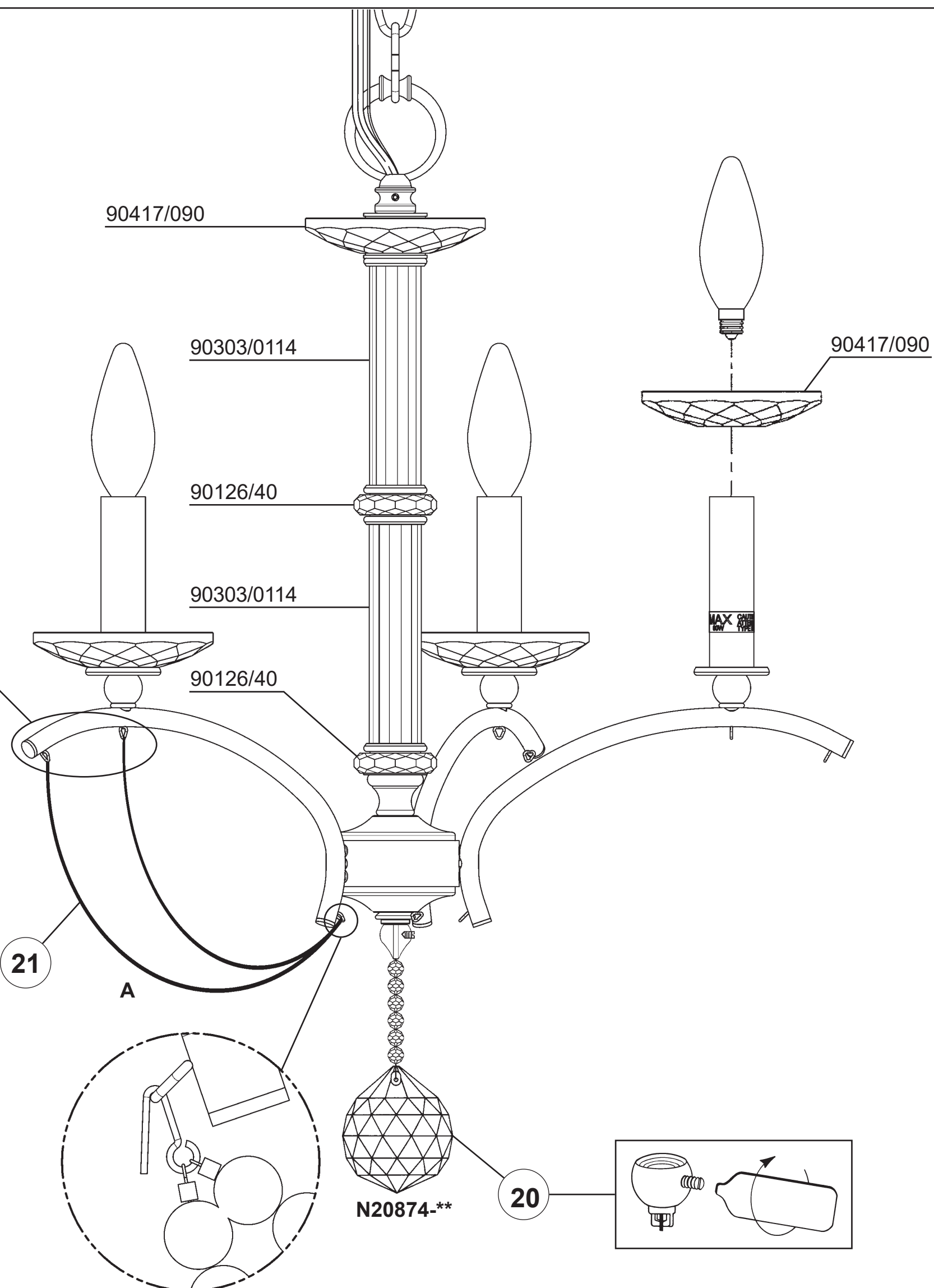
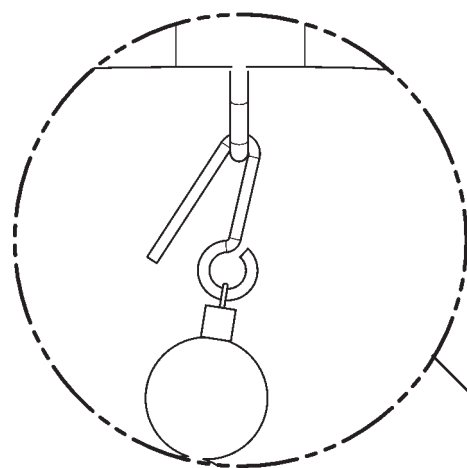

21

A

N20874-**

20

