

PRISCILLA BC7106N-__ __O













6 Lights
Diameter: 23-1/2"
Height: 23-1/2"
Hanging Weight: 10lbs.

THIS DESIGN IS THE PROPRIETARY
TRADE DRESS/TRADEMARK OF
W SCHONBEK LLC.

 **SCHONBEK** | 1870

 **SCHONBEK** | 1870

								
MAX <u>60</u> W	110-120 V							

WARNING:

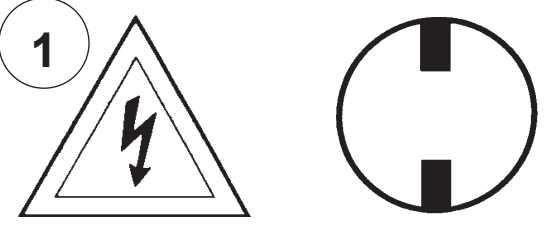
1 

Electrical Danger Turn Power Off

All electrical components must be installed by a licensed electrician in accordance with the National Electric Code and the appropriate local electrical codes.

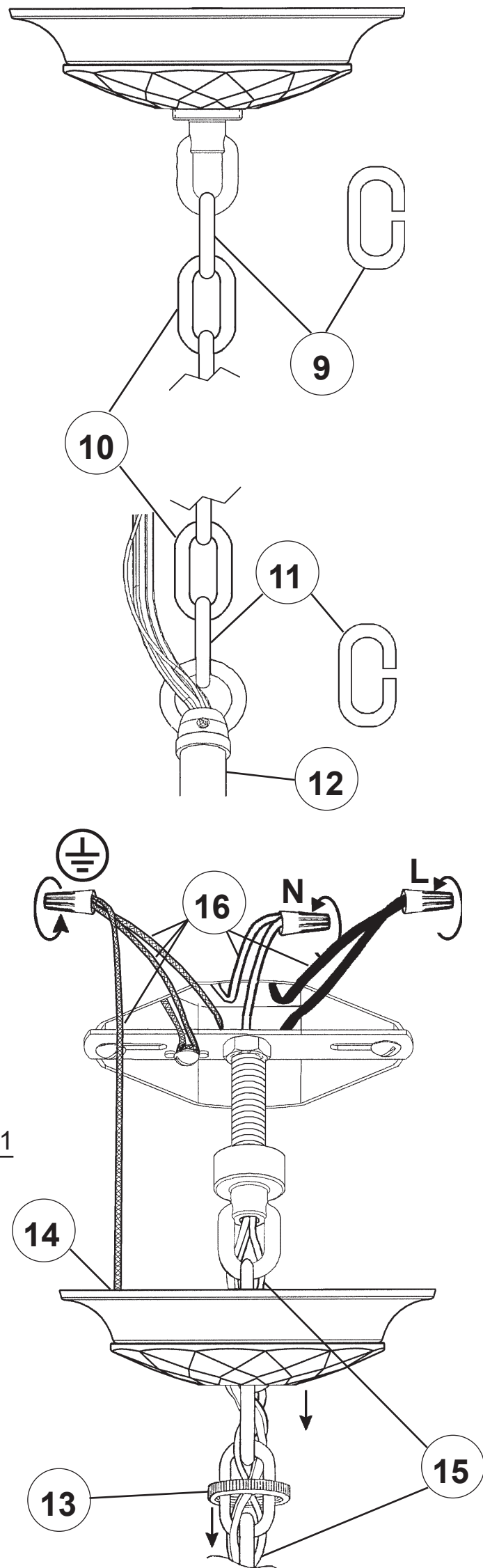
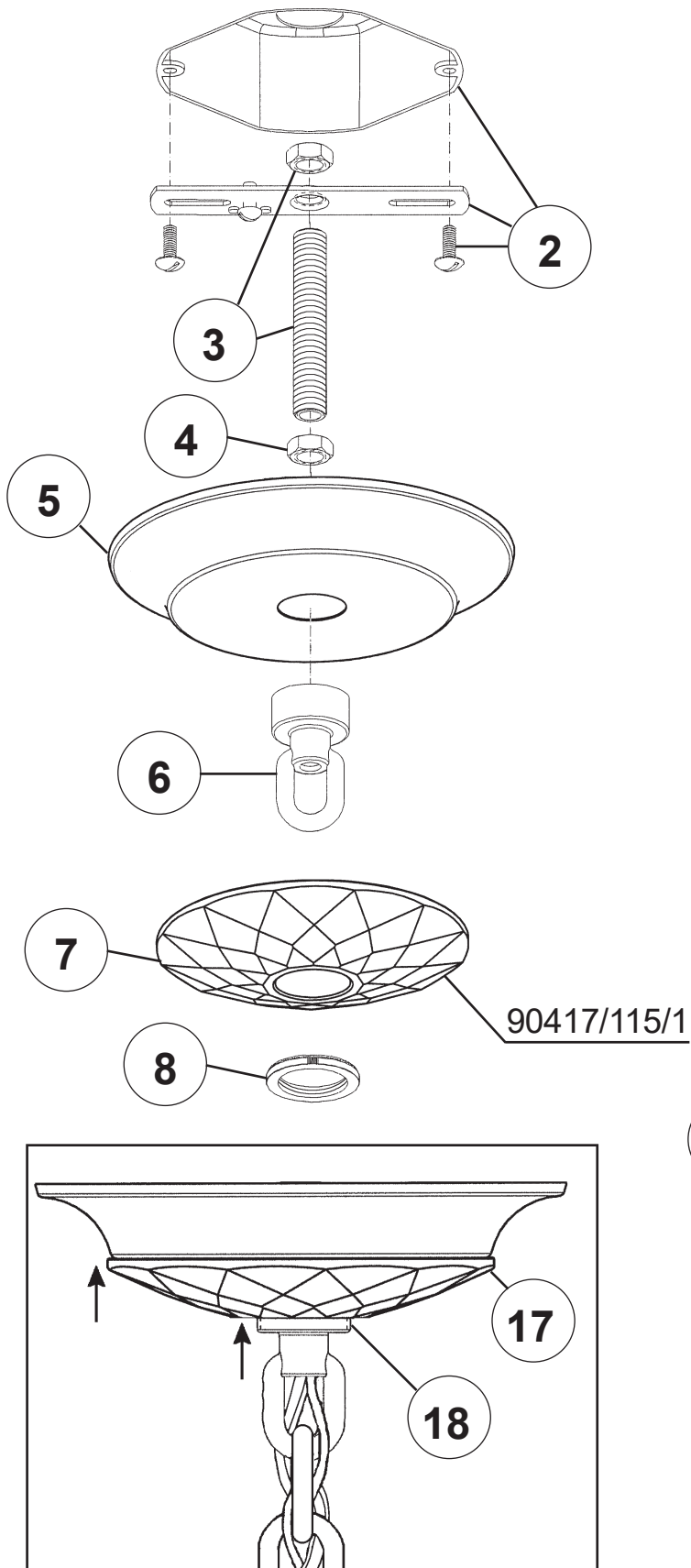

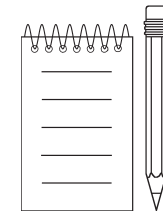

19

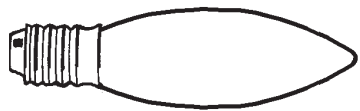

You will need 6 - B10
60 Watts Max

Install bulbs and be sure to
test fixture **BEFORE**
trimming.

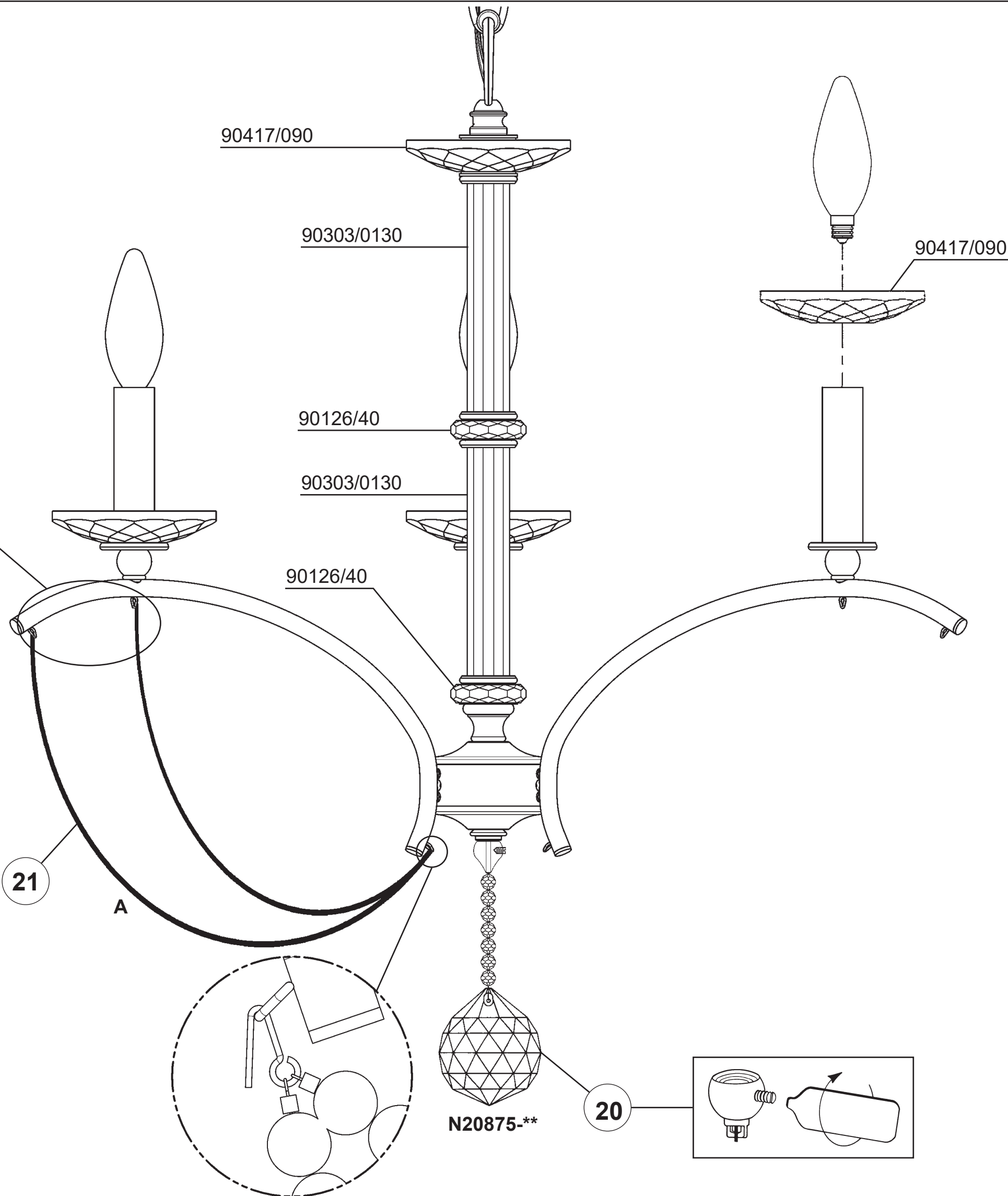
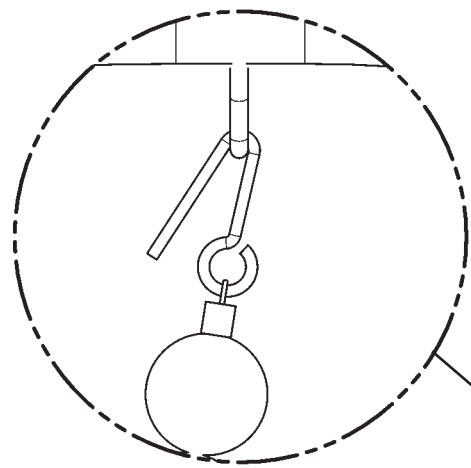

PRISCILLA BC7106N- __ __ P __ __













6 Lights
Diameter: 23-1/2"
Height: 23-1/2"
Hanging Weight: 10lbs.

THIS DESIGN IS THE PROPRIETARY
TRADE DRESS/TRADEMARK OF
W SCHONBEK LLC.

 **SCHONBEK** | 1870

 **SCHONBEK** | 1870

								
MAX 60 W	110-120 V							

WARNING:

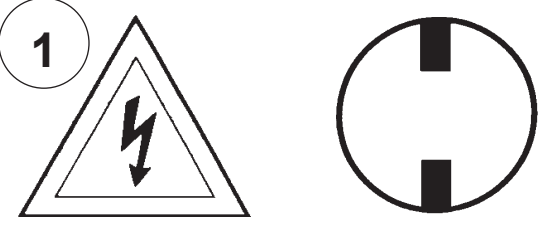
1 

Electrical Danger Turn Power Off

All electrical components must be installed by a licensed electrician in accordance with the National Electric Code and the appropriate local electrical codes.

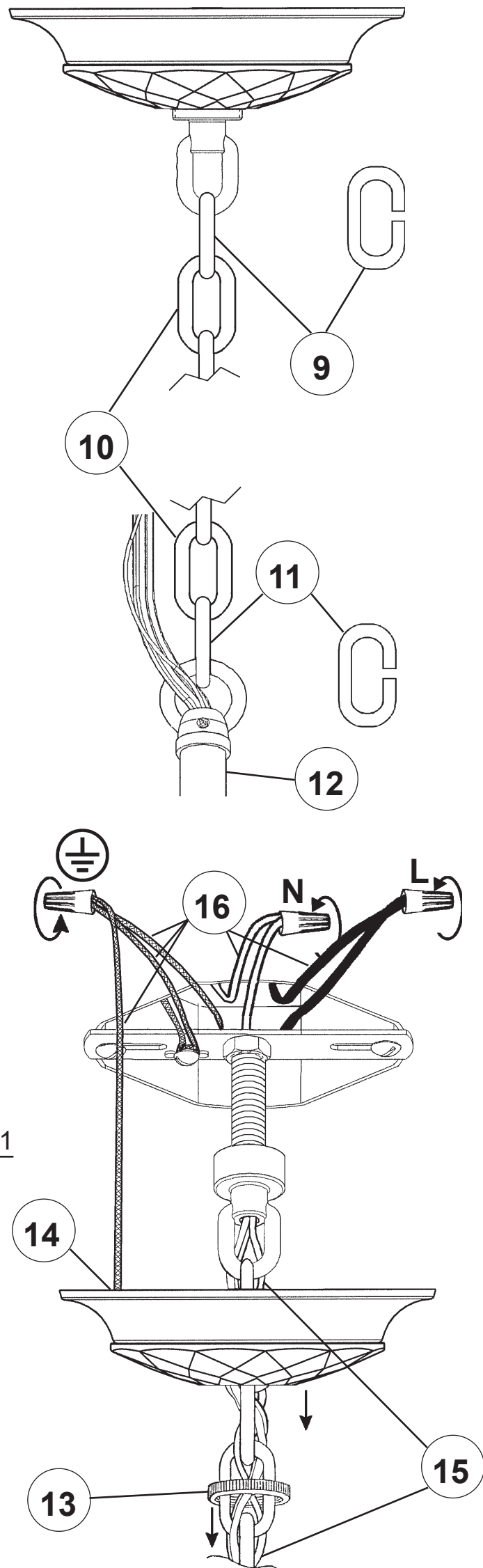
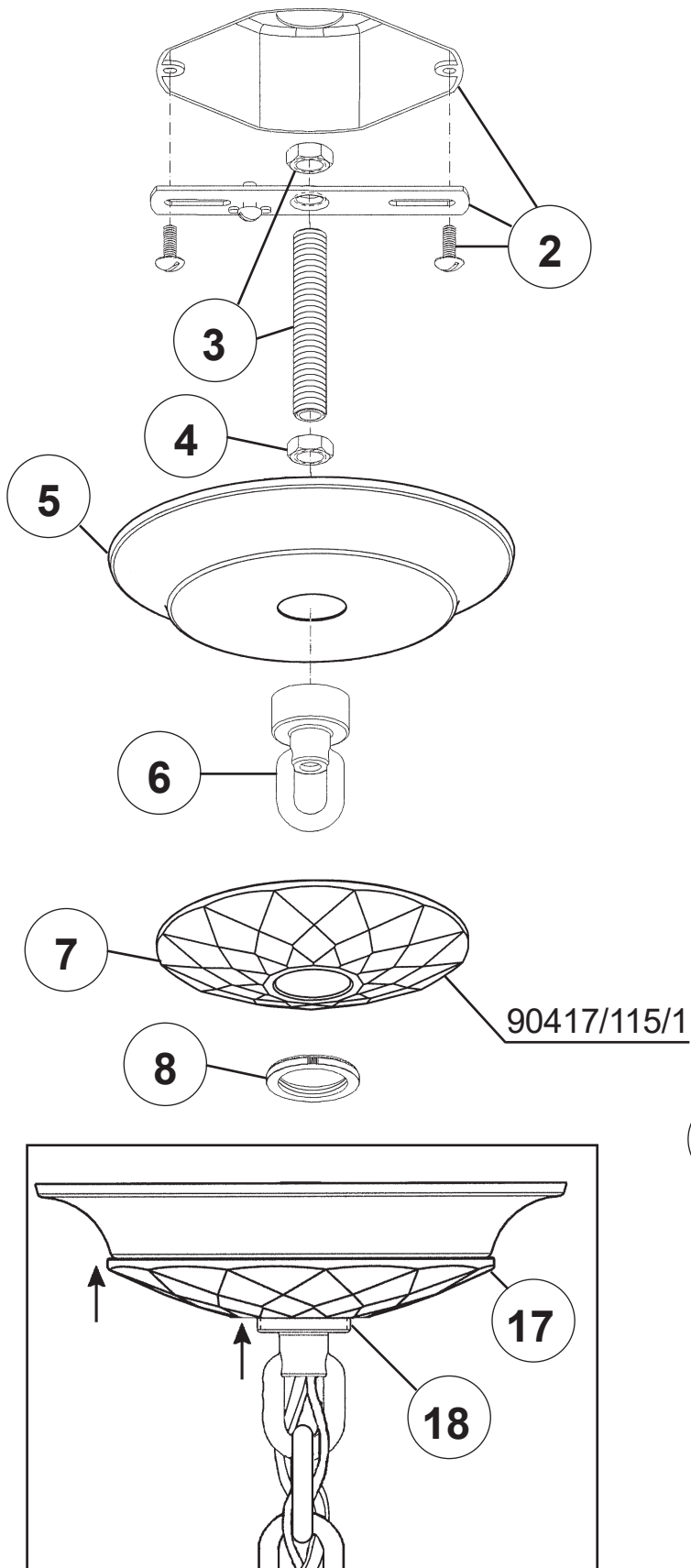

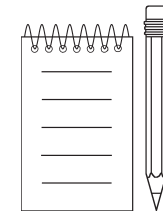
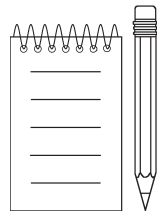

19



You will need 6 - B10
60 Watts Max

Install bulbs and be sure to
test fixture **BEFORE**
trimming.

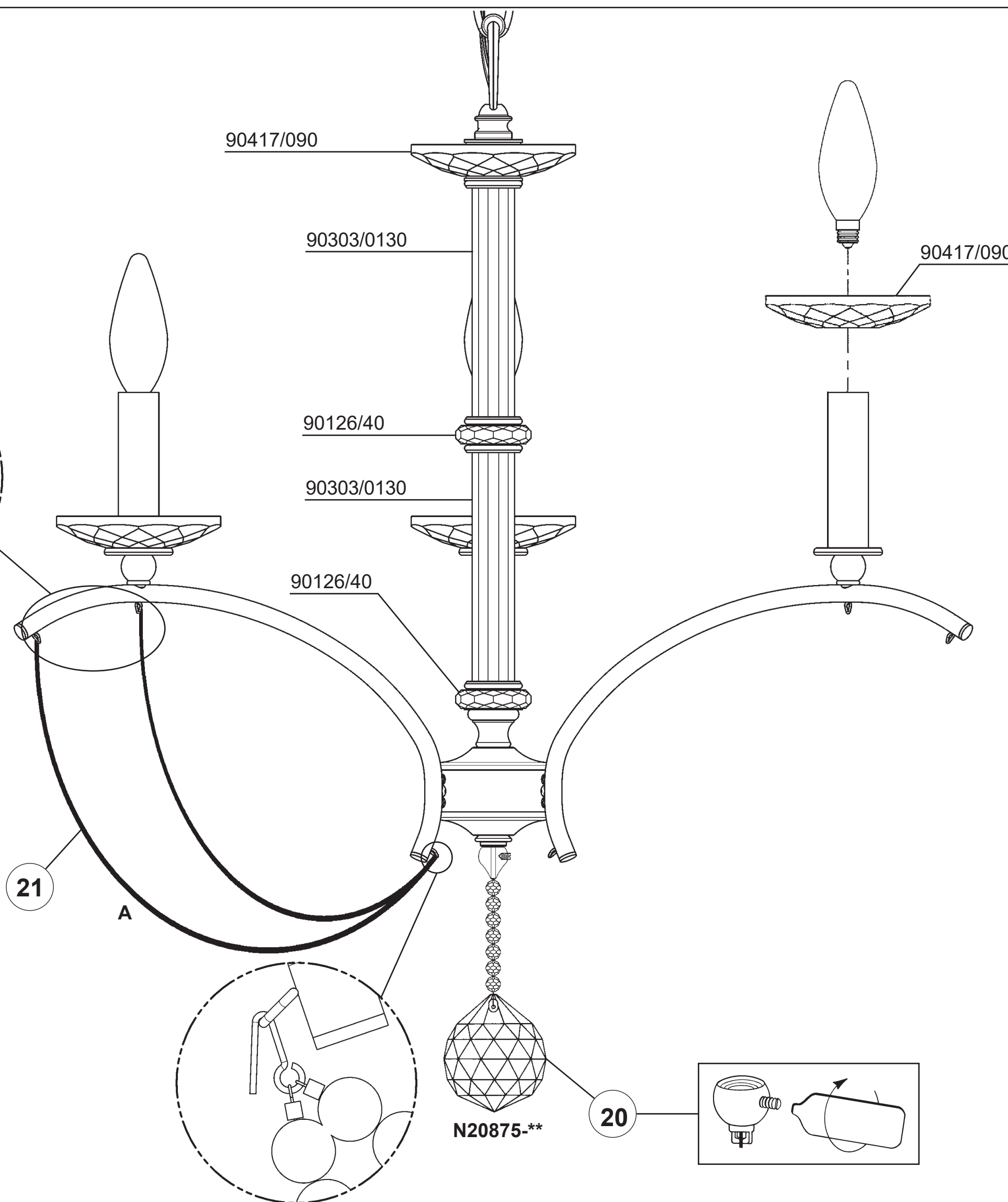
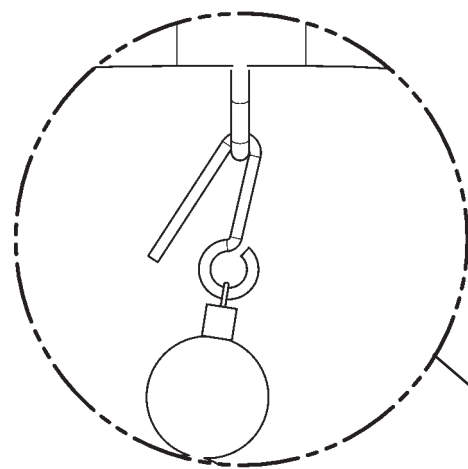

21

A

N20875-**

20

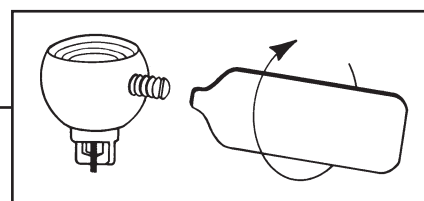

PRISCILLA BC7106N- __ __ P __ __











6 Lights
Diameter: 23-1/2"
Height: 23-1/2"
Hanging Weight: 10lbs.

THIS DESIGN IS THE PROPRIETARY
TRADE DRESS/TRADEMARK OF
W SCHONBEK LLC.

 **SCHONBEK** | 1870

 **SCHONBEK** | 1870

			S					
MAX 60 W	110-120 V							

WARNING:

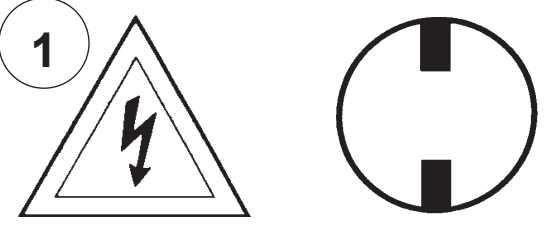

1 Electrical Danger Turn Power Off

All electrical components must be installed by a licensed electrician in accordance with the National Electric Code and the appropriate local electrical codes.

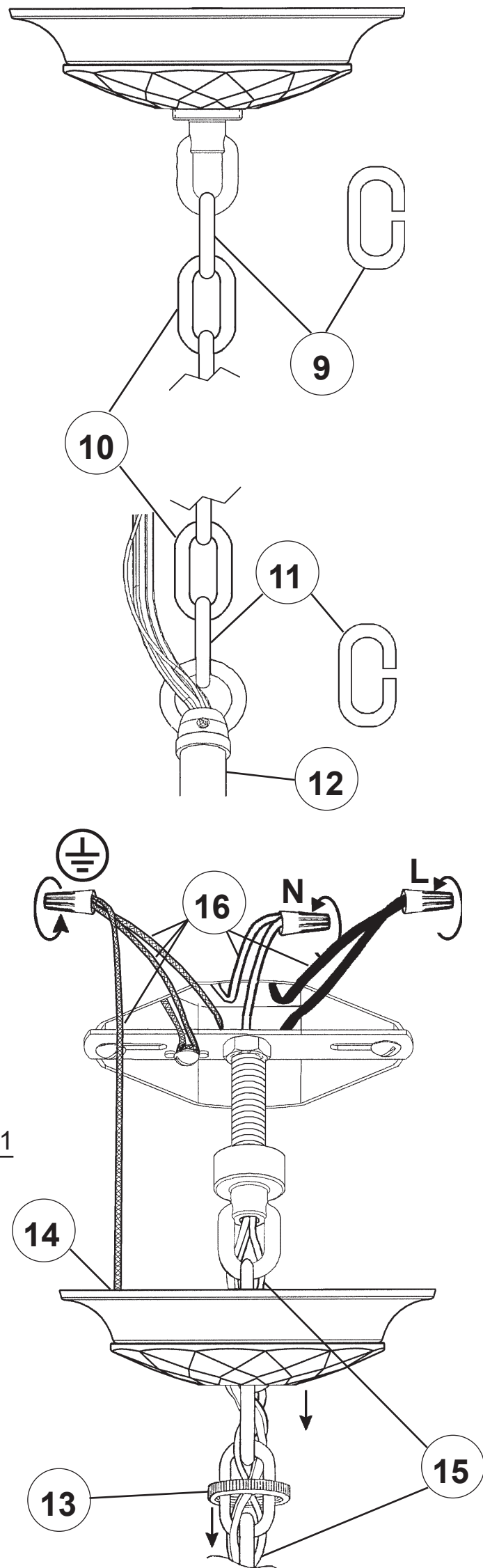
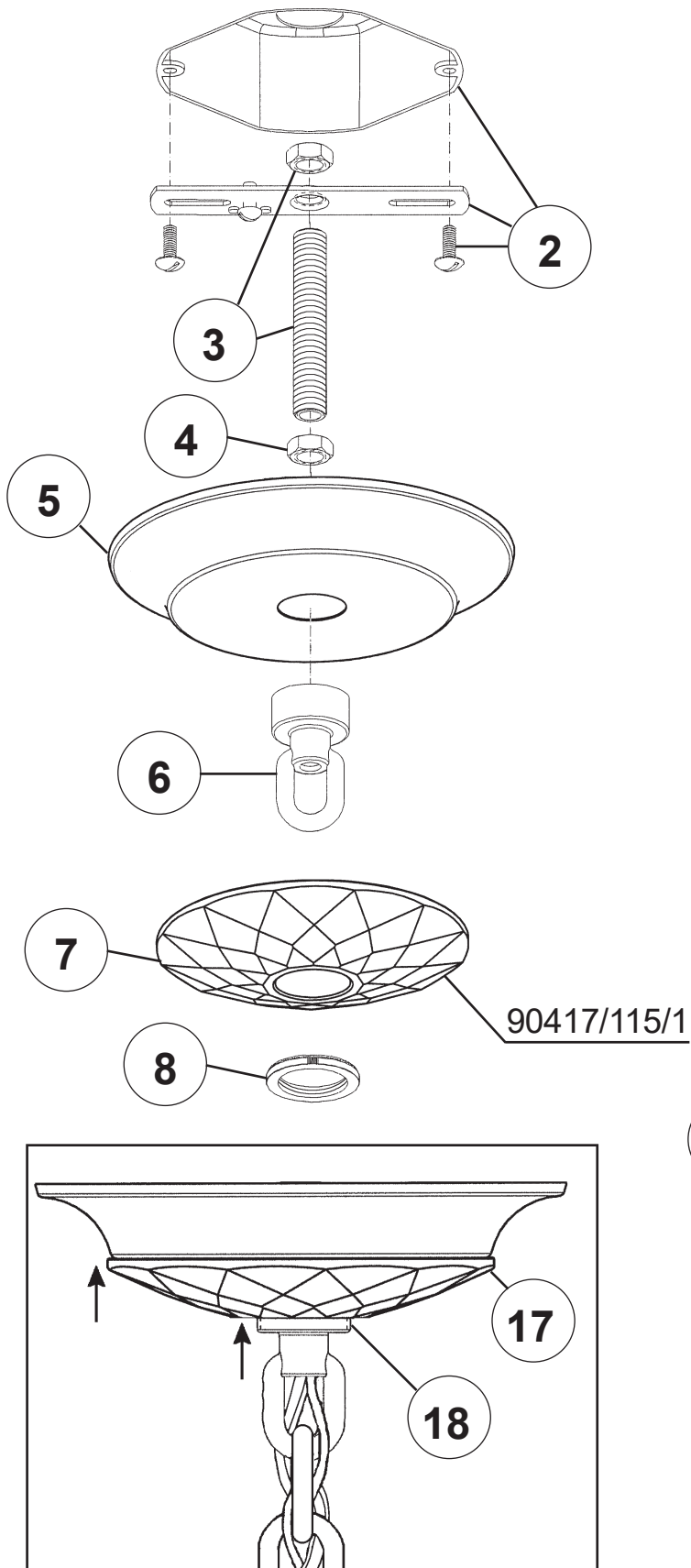

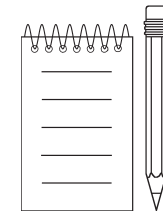

19



You will need 6 - B10
60 Watts Max

Install bulbs and be sure to
test fixture **BEFORE**
trimming.

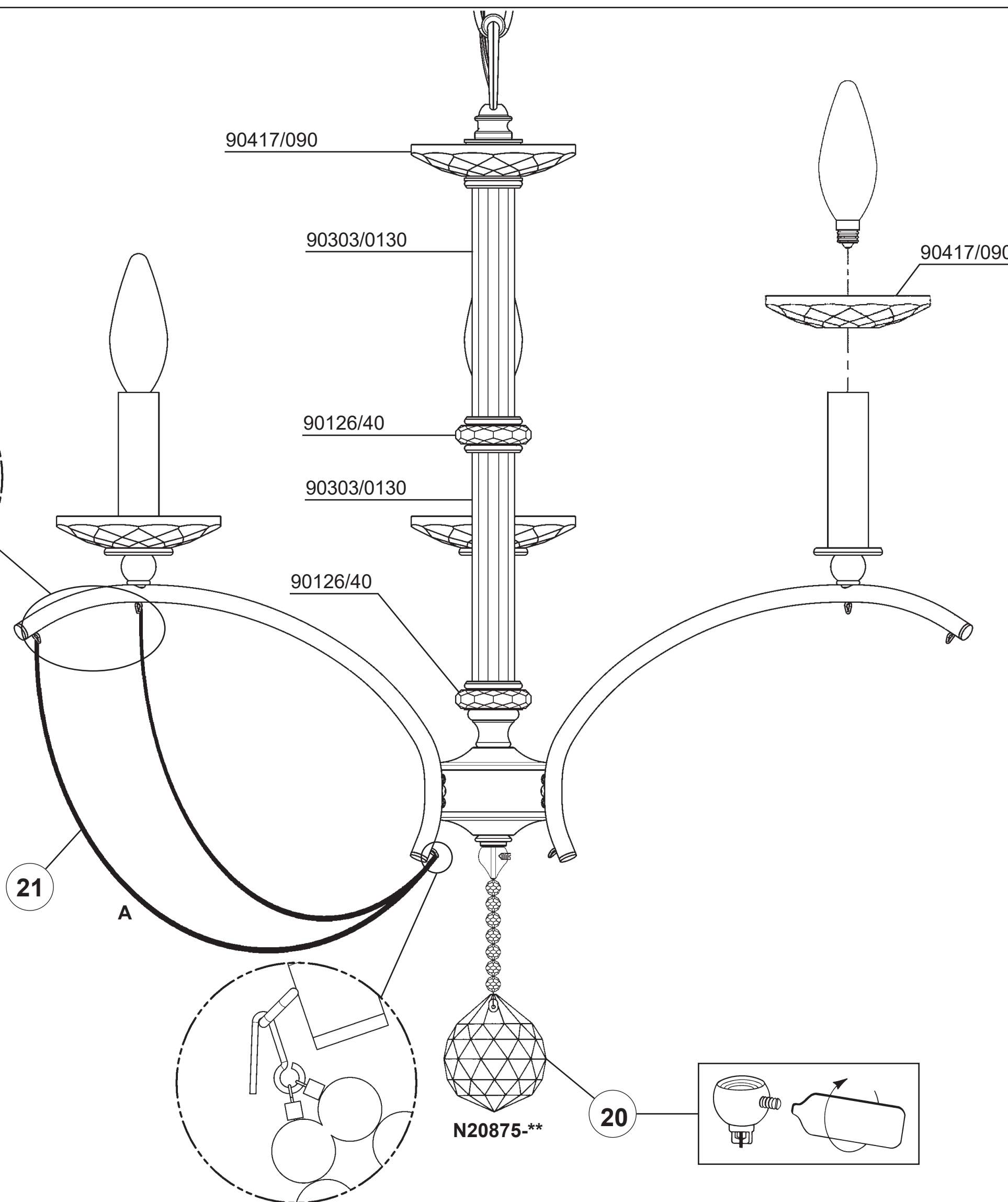
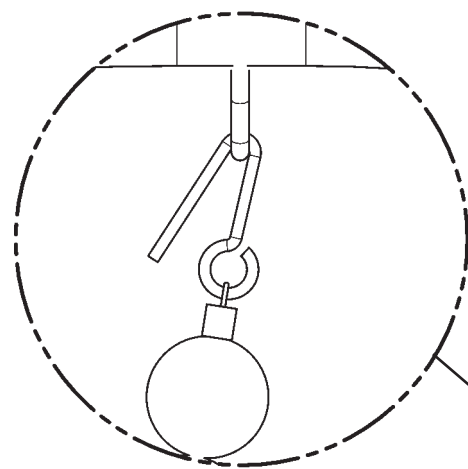

21

A

N20875-**

20



PRISCILLA BC7106N- __ __ P __ __













6 Lights
Diameter: 23-1/2"
Height: 23-1/2"
Hanging Weight: 10lbs.

THIS DESIGN IS THE PROPRIETARY
TRADE DRESS/TRADEMARK OF
W SCHONBEK LLC.

 **SCHONBEK** | 1870

 **SCHONBEK** | 1870

								
MAX <u>60</u> W	110-120 V							

WARNING:

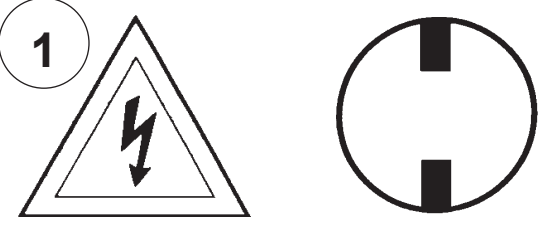
1 

Electrical Danger Turn Power Off

All electrical components must be installed by a licensed electrician in accordance with the National Electric Code and the appropriate local electrical codes.

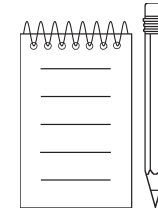
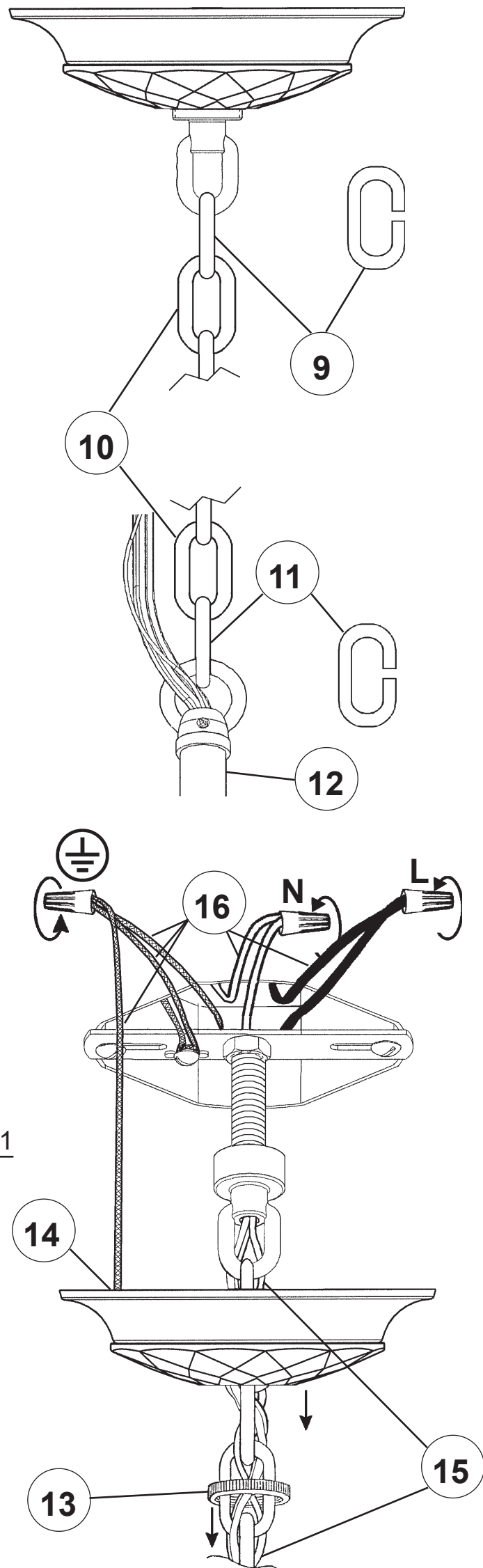
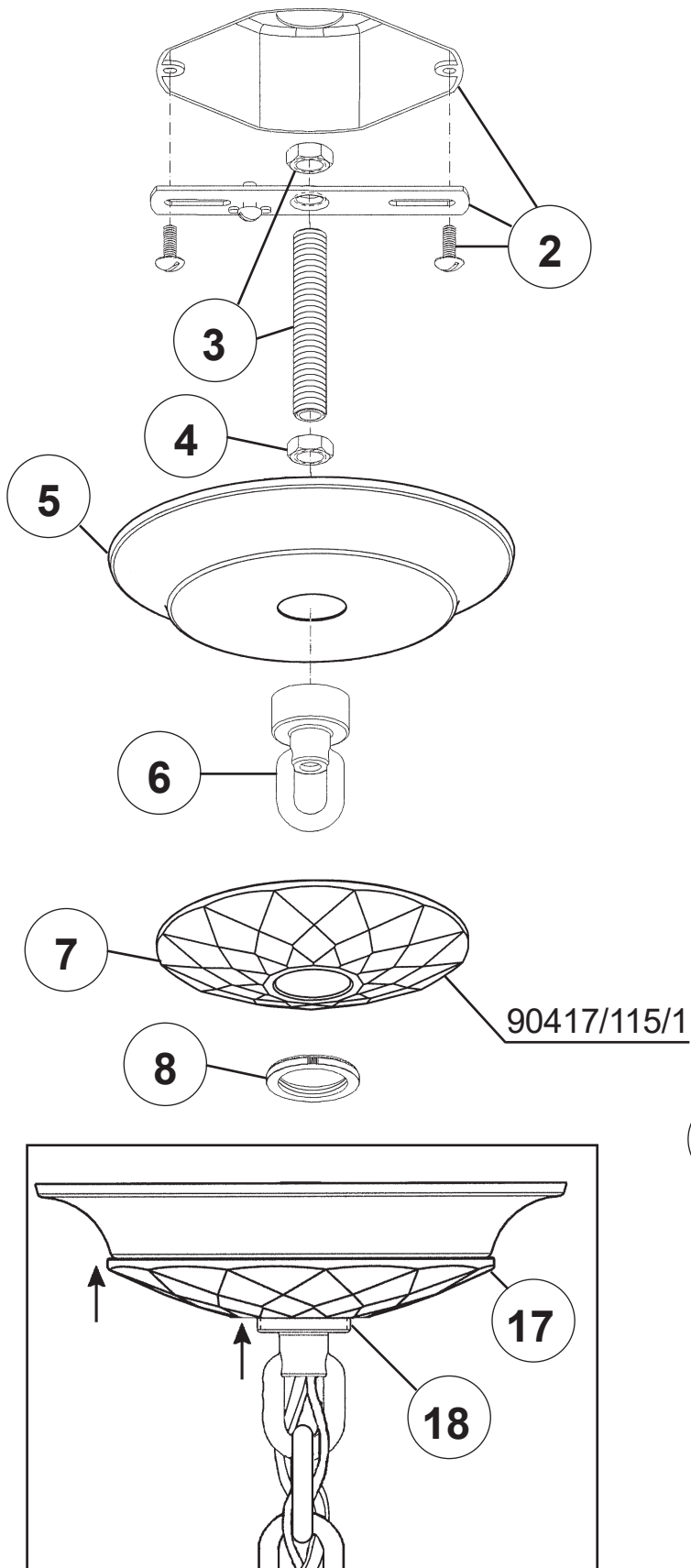

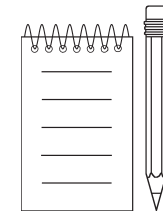
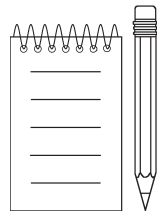

19



You will need 6 - B10
60 Watts Max

Install bulbs and be sure to
test fixture **BEFORE**
trimming.

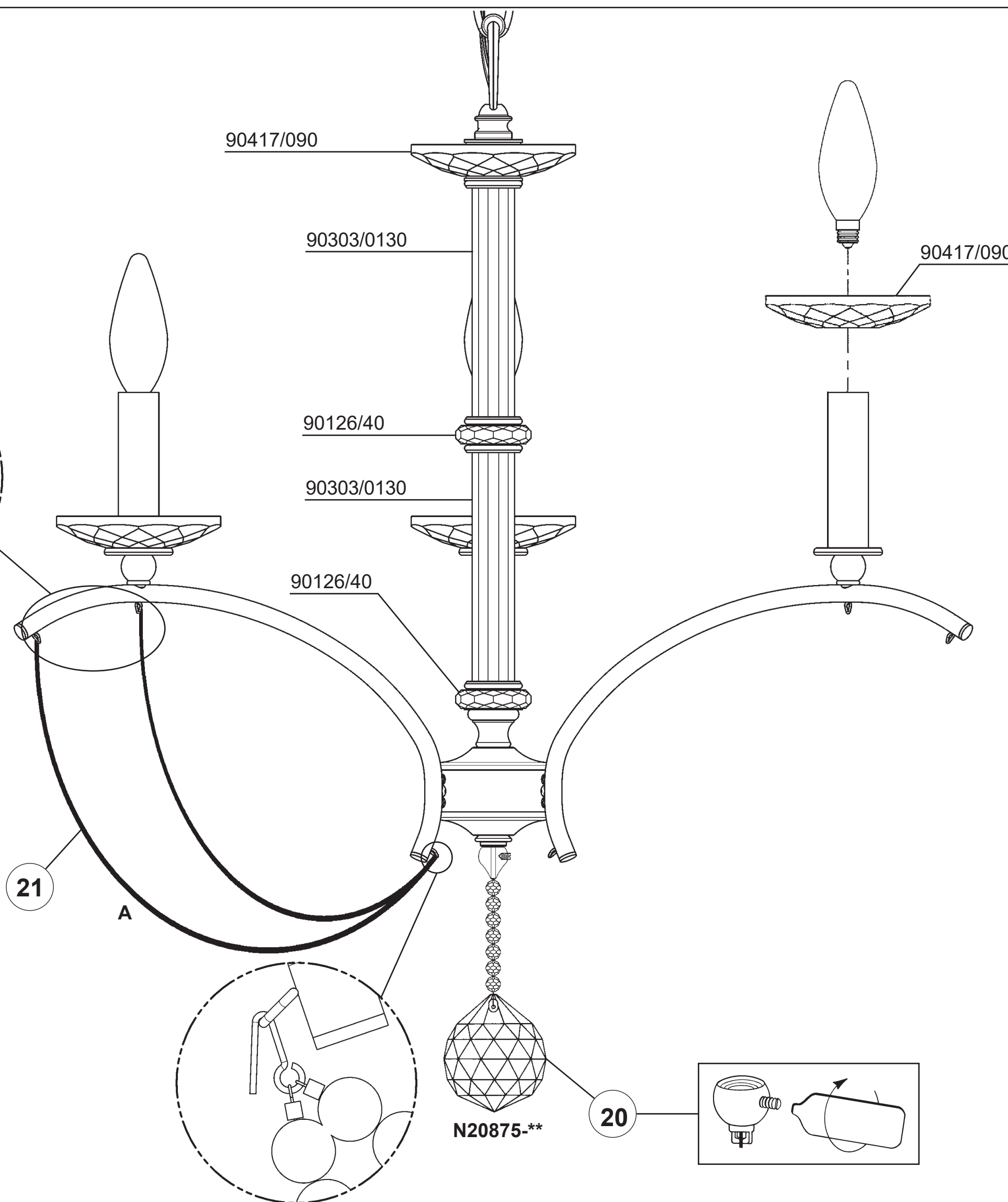
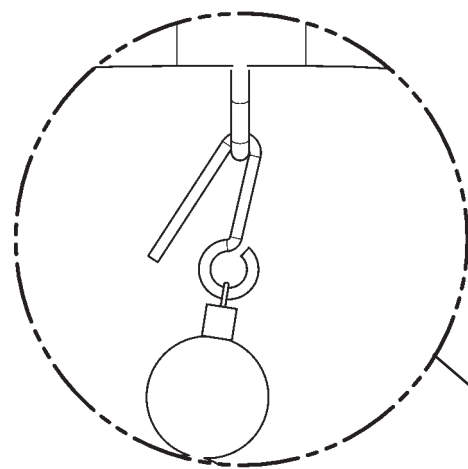

21

A

N20875-**

20

