

# BARONET BN1024N-\_\_ \_\_O













12 Lights  
Diameter: 24"  
Height: 20"  
Hanging Weight: 33lbs.

**T**HIS DESIGN IS THE PROPRIETARY  
TRADE DRESS/TRADEMARK OF  
W SCHONBEK LLC.

 **SCHONBEK** | 1870

 **SCHONBEK** | 1870

								
MAX <u>60</u> W	110-120 V							

**WARNING:**

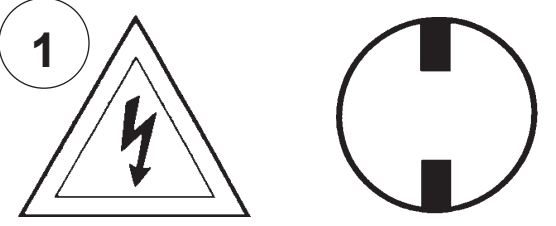
1 

**Electrical Danger Turn Power Off**

All electrical components must be installed by a licensed electrician in accordance with the National Electric Code and the appropriate local electrical codes.

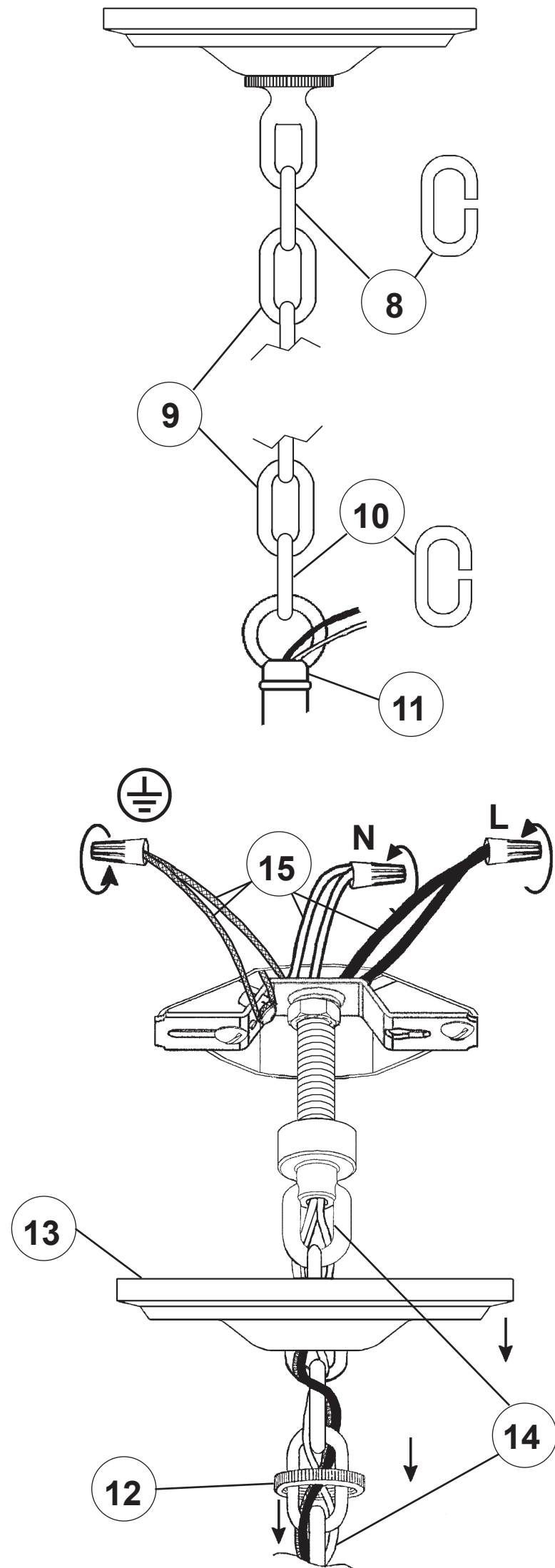
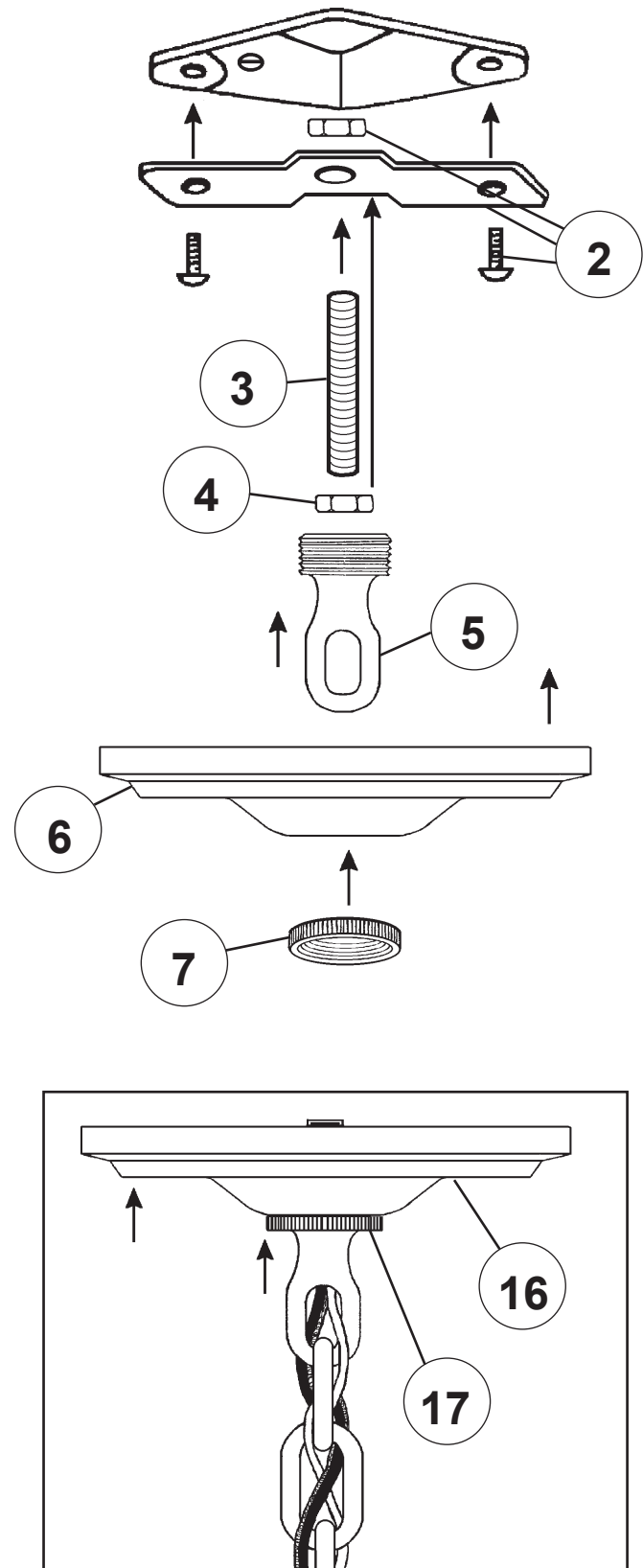

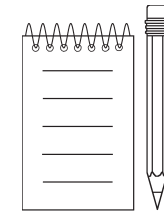
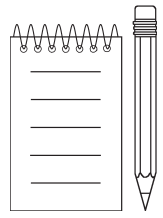

18

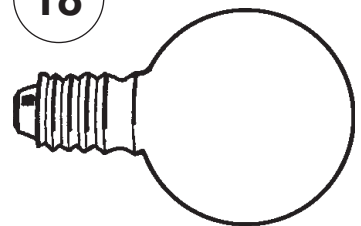

You will need 12 - G16-1/2  
60 Watts Max

Install bulbs and be sure  
to test fixture BEFORE  
trimming.

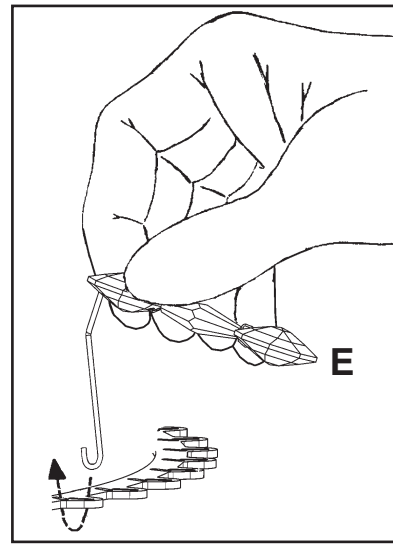

19

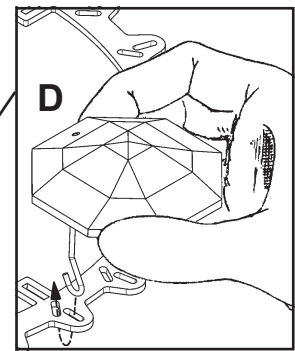

20

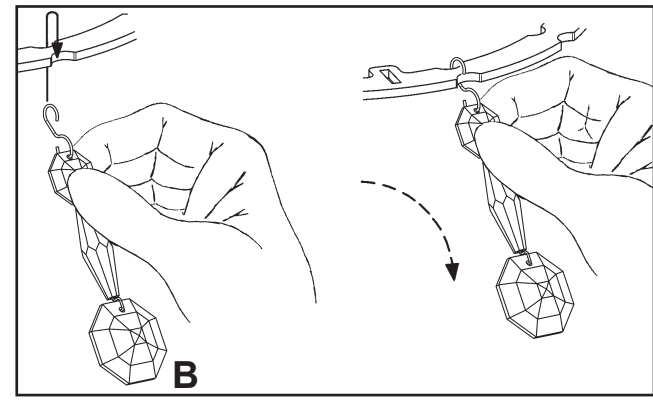
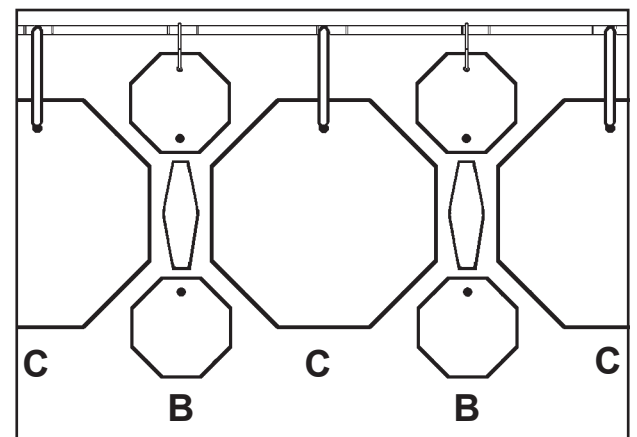
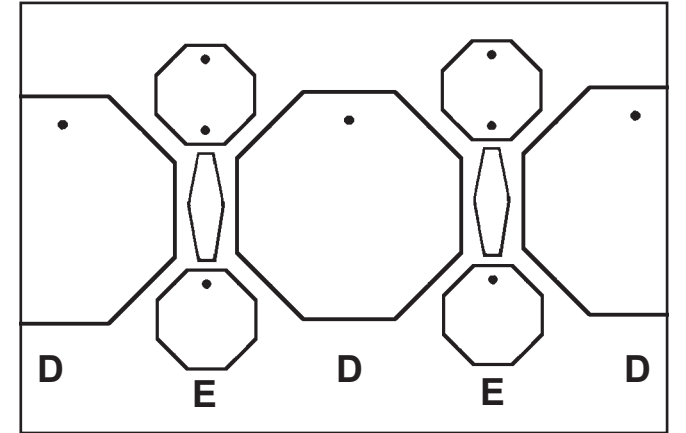

28

26

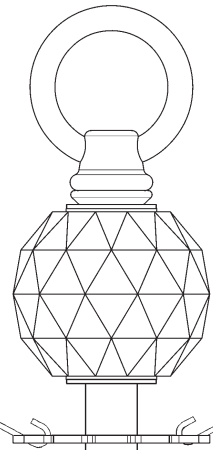

N21296-\*\*

25

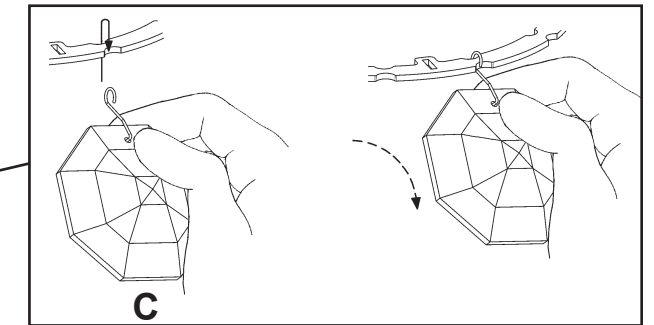
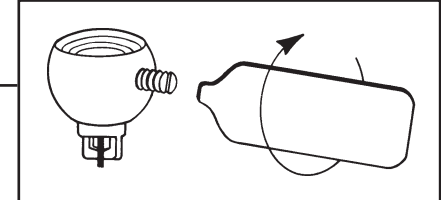

29

27

21

23

35

34

32

30

22

24

36

33

31



# BARONET BN1024N-\_\_ \_\_R













12 Lights  
Diameter: 24"  
Height: 20"  
Hanging Weight: 33lbs.

**T**HIS DESIGN IS THE PROPRIETARY  
TRADE DRESS/TRADEMARK OF  
W SCHONBEK LLC.

 **SCHONBEK** | 1870

 **SCHONBEK** | 1870

								
MAX <b>60</b> W	110-120 V							

**WARNING:**

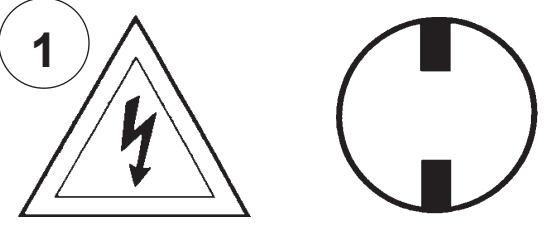
1 

**Electrical Danger Turn Power Off**

All electrical components must be installed by a licensed electrician in accordance with the National Electric Code and the appropriate local electrical codes.

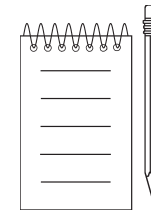
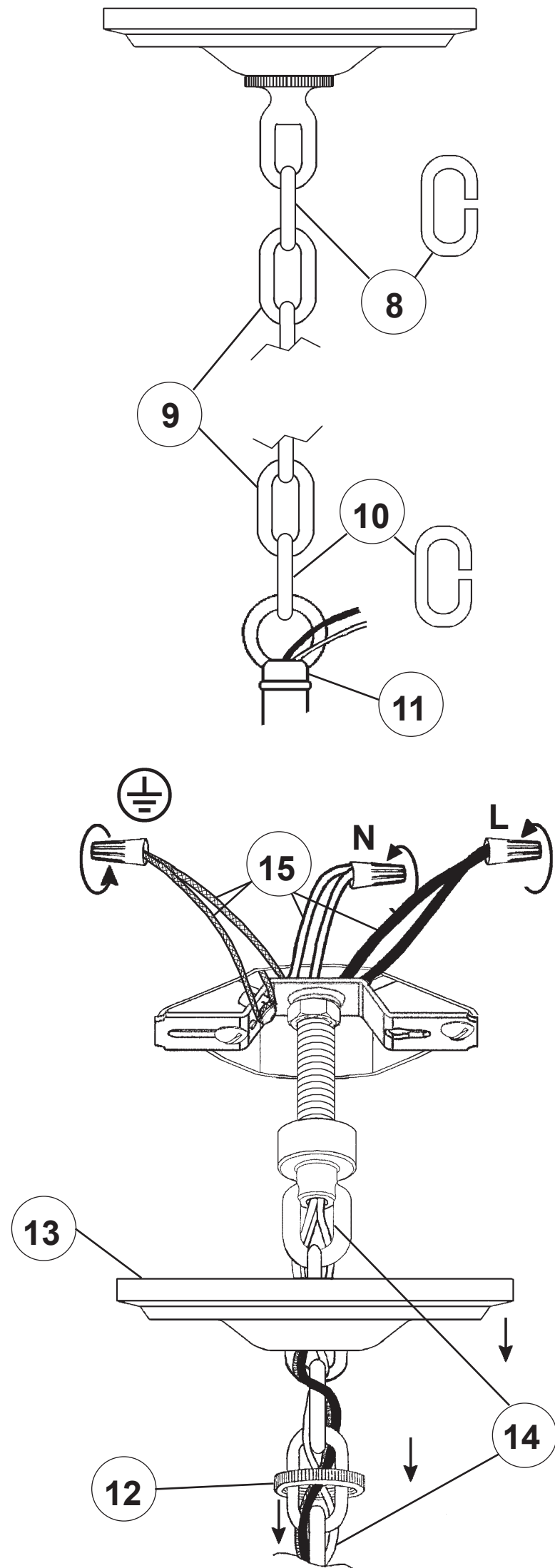
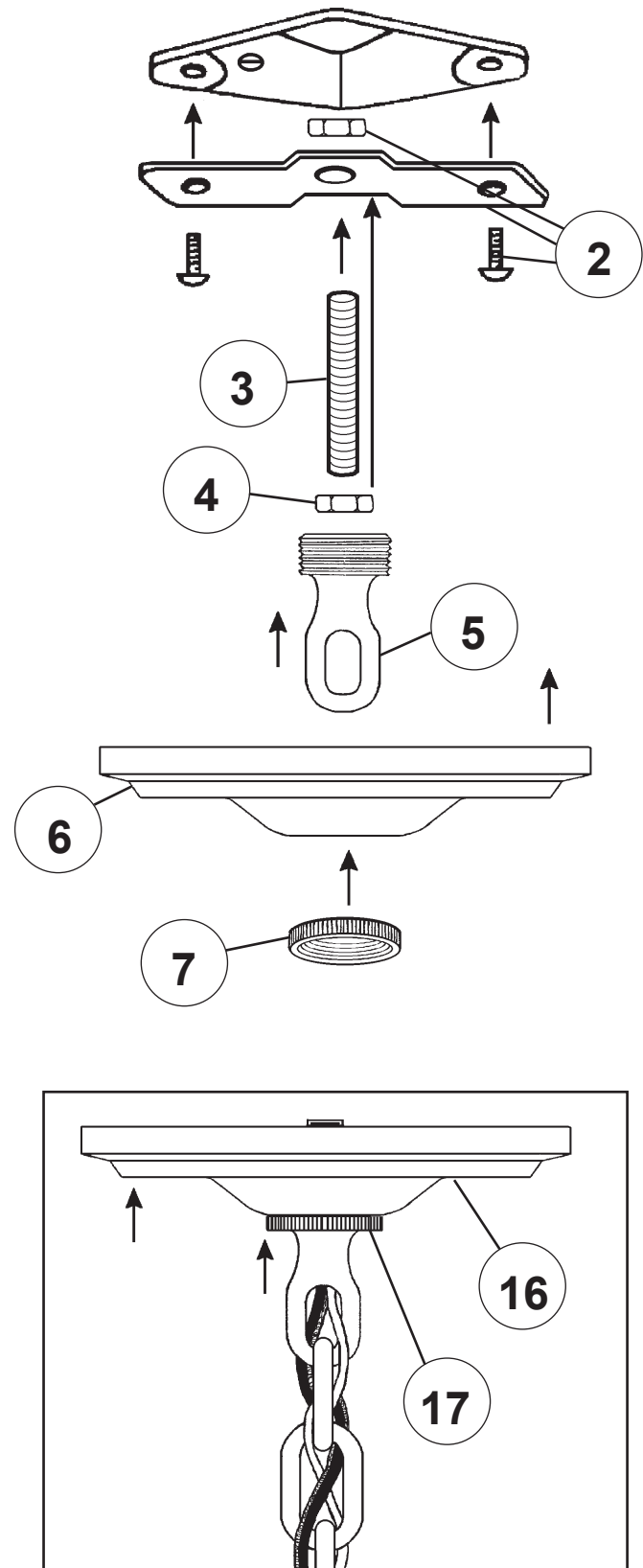

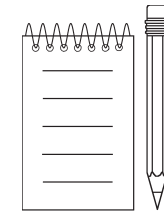
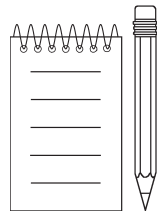

18

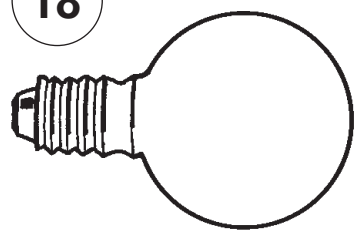

You will need 12 - G16-1/2  
60 Watts Max

Install bulbs and be sure  
to test fixture BEFORE  
trimming.

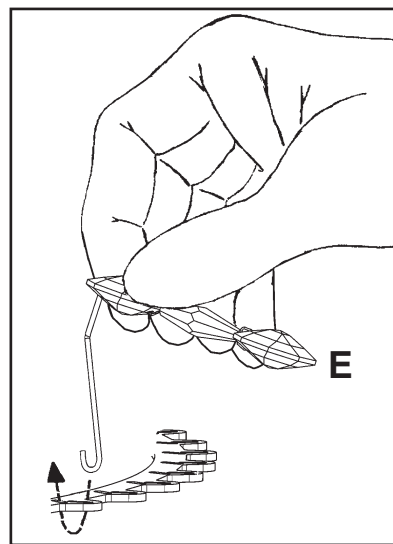

19

E

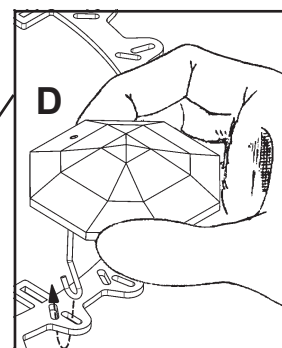

20

D

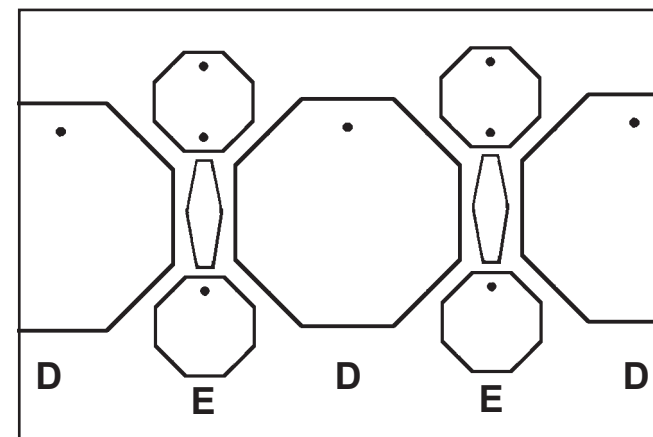

D

E

D

E

D

21

E

23

E

35

E

34

A

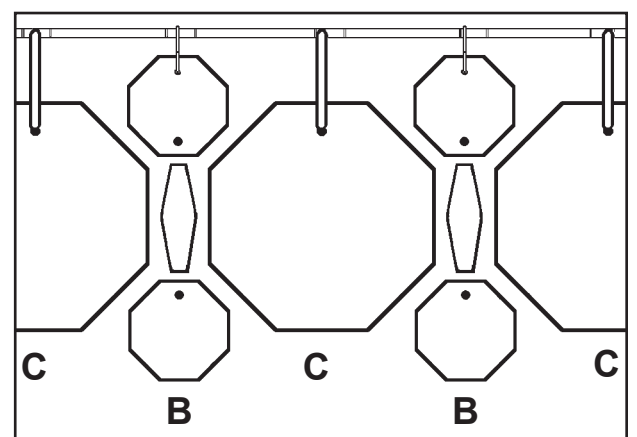

C

B

C

B

C

32

B

30

B

28

B

26

B

NR20119-\*\*

25

27

C

29

C

31

C

33

C

36

D

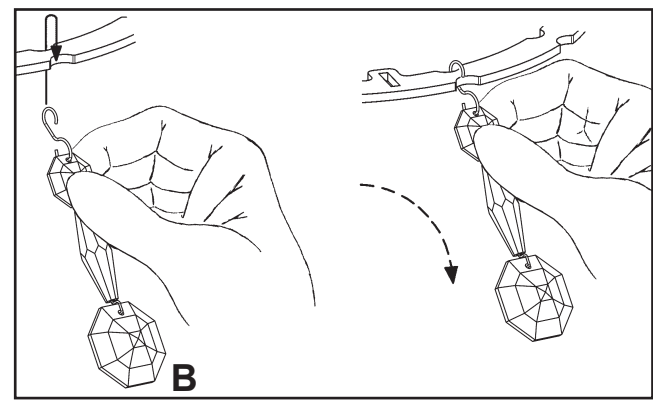

B

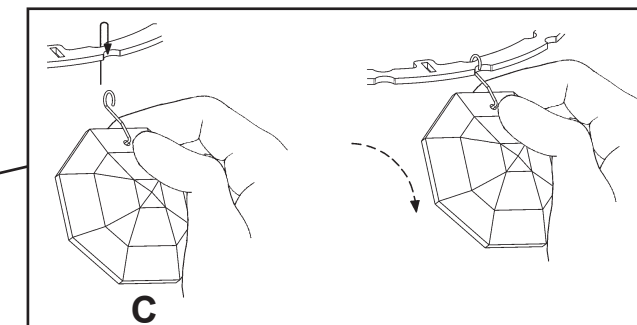

C

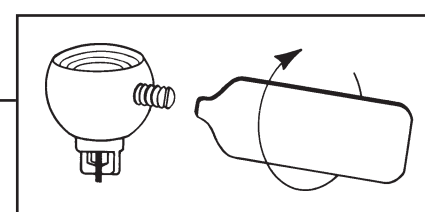



# BARONET BN1024N- \_\_ \_\_ S













12 Lights  
Diameter: 24"  
Height: 20"  
Hanging Weight: 33lbs.

**T**HIS DESIGN IS THE PROPRIETARY  
TRADE DRESS/TRADEMARK OF  
W SCHONBEK LLC.

 **SCHONBEK** | 1870

 **SCHONBEK** | 1870

								
MAX <b>60</b> W	110-120 V							

**WARNING:**

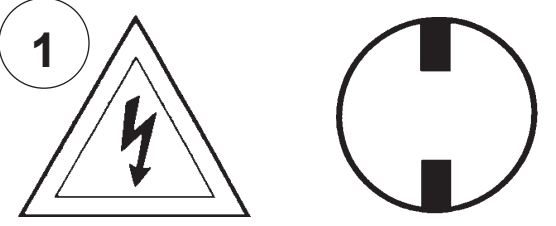
1 

**Electrical Danger Turn Power Off**

All electrical components must be installed by a licensed electrician in accordance with the National Electric Code and the appropriate local electrical codes.

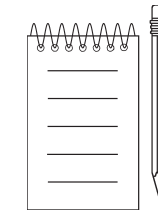
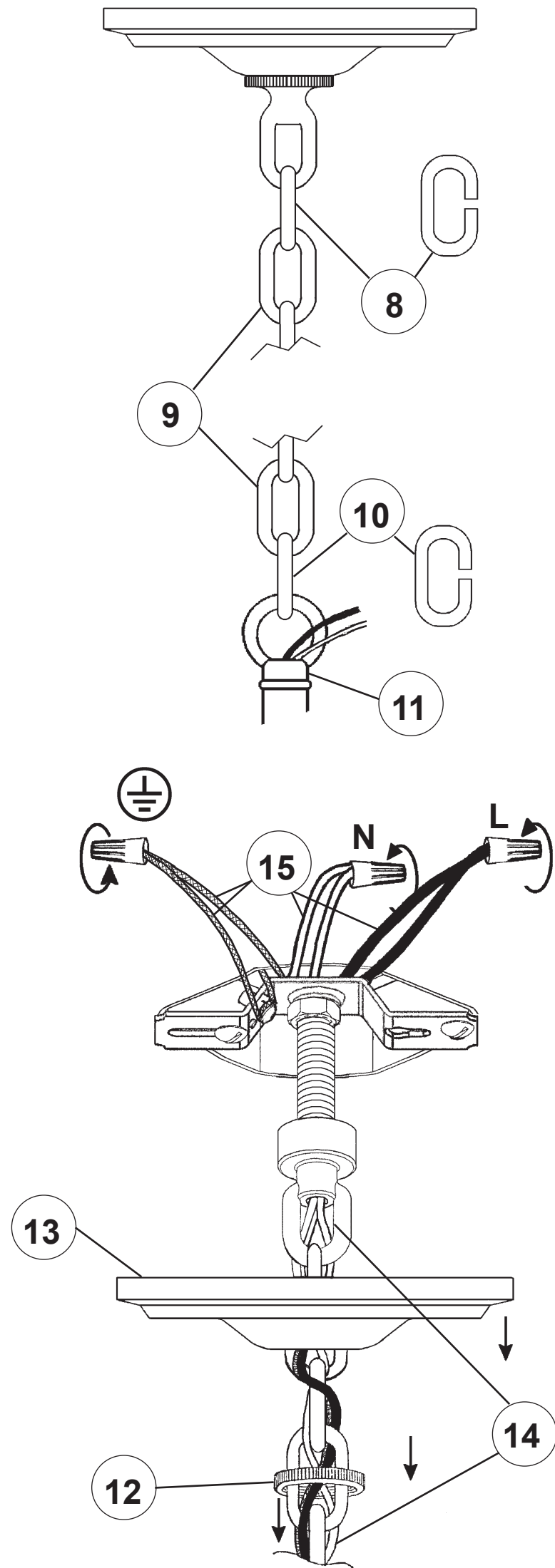
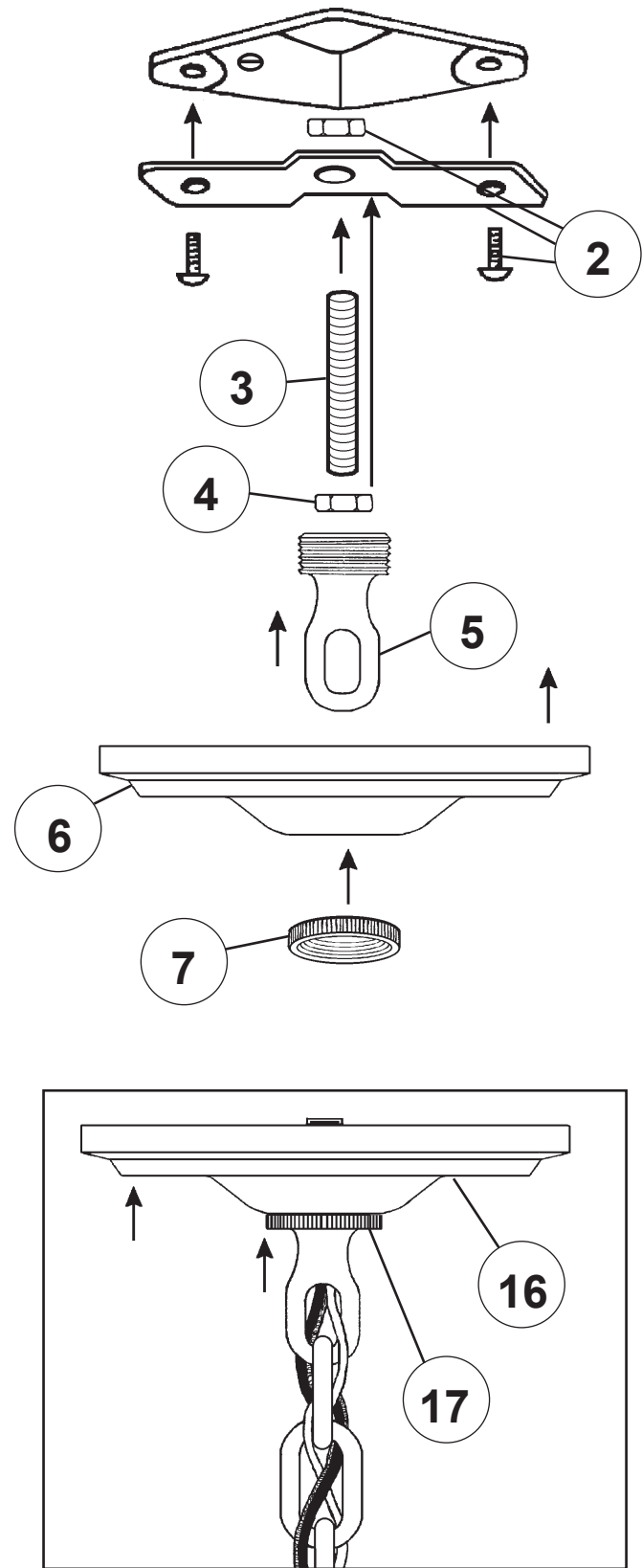

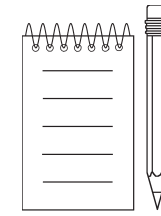
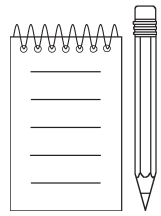

18

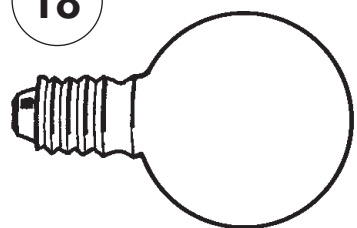

You will need 12 - G16-1/2  
60 Watts Max

Install bulbs and be sure  
to test fixture BEFORE  
trimming.

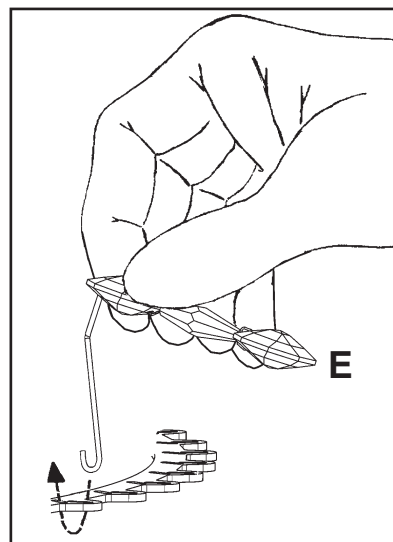

19

E

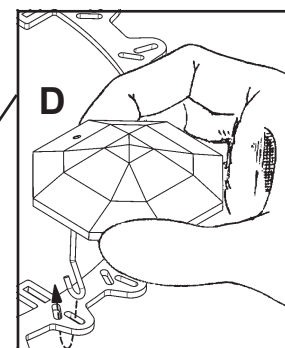

20

D

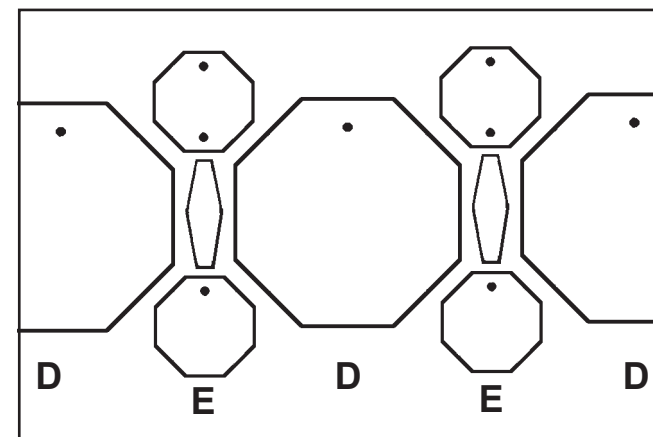

D

E

D

E

D

21

E

23

E

35

E

34

A

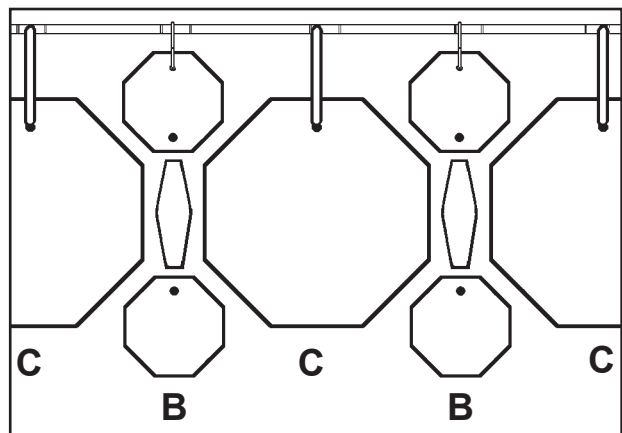

C

B

C

B

C

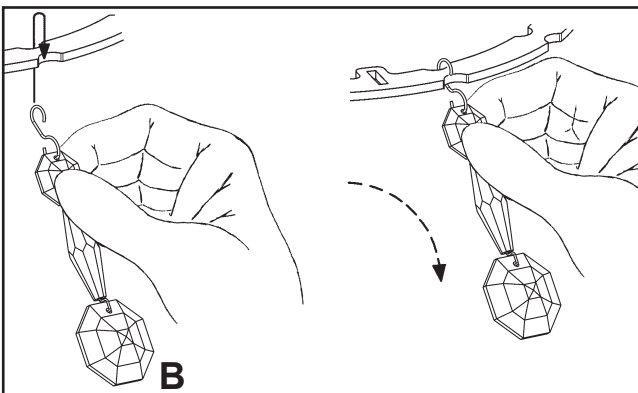

B

32

B

30

B

28

B

26

B

N20119-\*\*

25

27

C

29

C

31

C

33

C

36

D

D

D

22

D

D

D

E

D

E

D

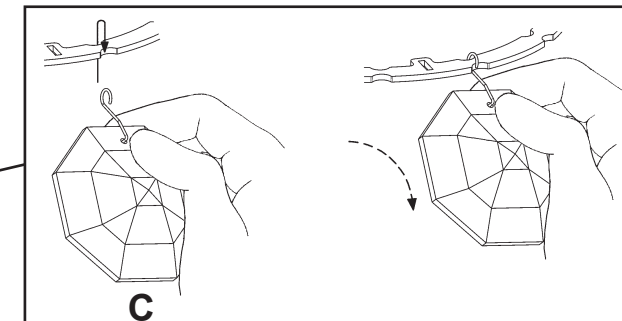

C

