

BARONET BN1033N-__ __O













28 Lights
Diameter: 33"
Height: 27"
Hanging Weight: 60lbs.

THIS DESIGN IS THE PROPRIETARY
TRADE DRESS/TRADEMARK OF
W SCHONBEK LLC.

 **SCHONBEK** | 1870

 **SCHONBEK** | 1870

								
MAX <u>60</u> W	110-120 V							

WARNING:

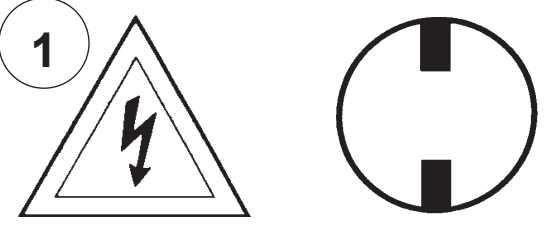

1 Electrical Danger Turn Power Off

All electrical components must be installed by a licensed electrician in accordance with the National Electric Code and the appropriate local electrical codes.

WARNING: THIS LUMINAIRE MUST BE MOUNTED OR SUPPORTED INDEPENDENTLY OF AN OUTLET BOX.

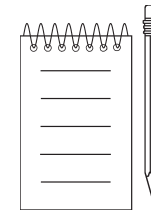
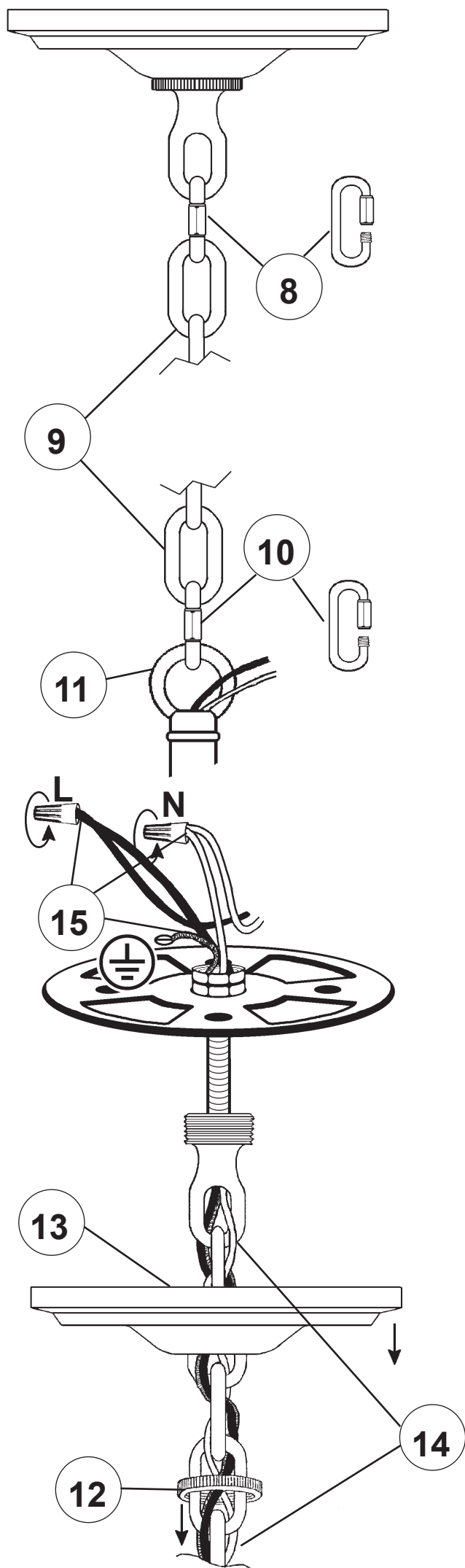
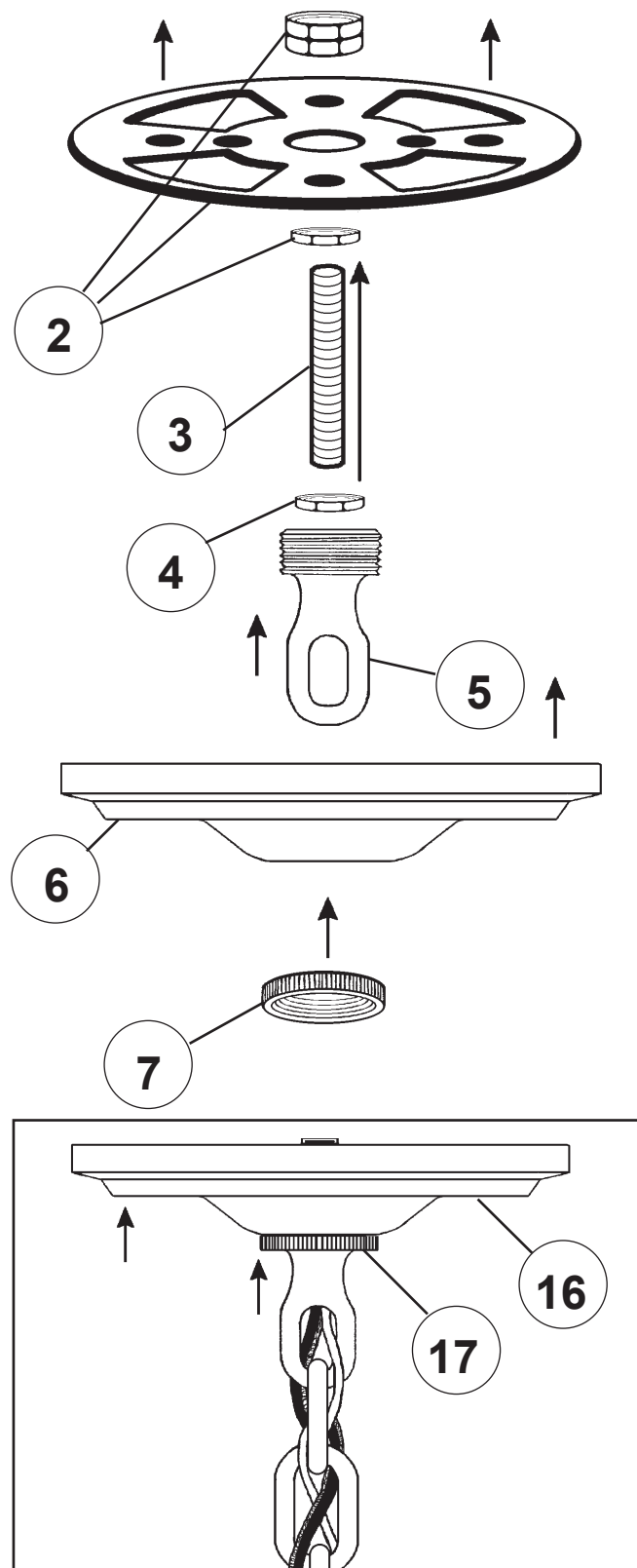

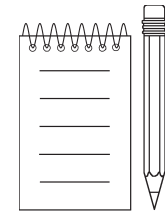

18



You will need 28 - B10
60 Watts Max

Install bulbs and be sure
to test fixture BEFORE
trimming.

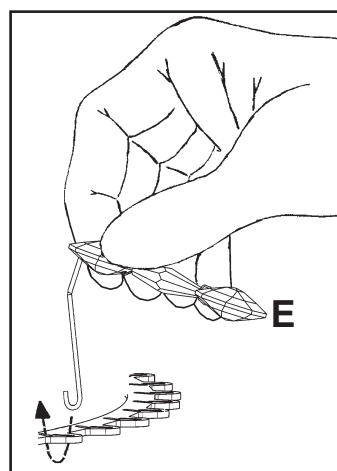

19

E

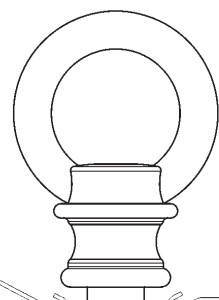

20

D

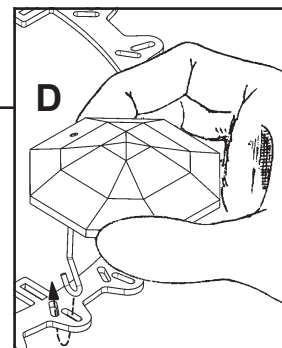

D

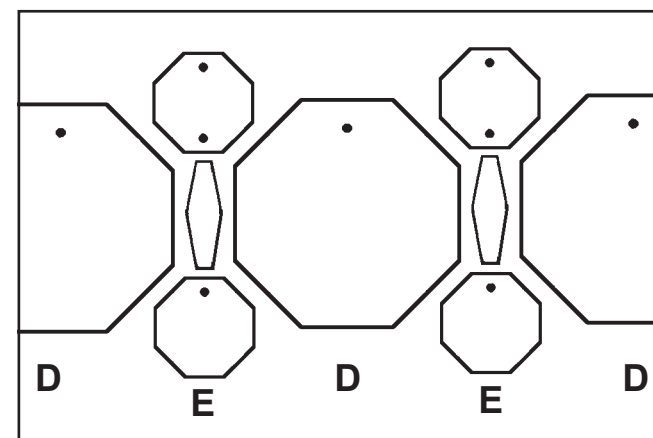

D

E

D

E

D

21

E

23

E

22

D

24

D

25

E

26

D

41

E

42

D

40

A

B

38

B

C

39

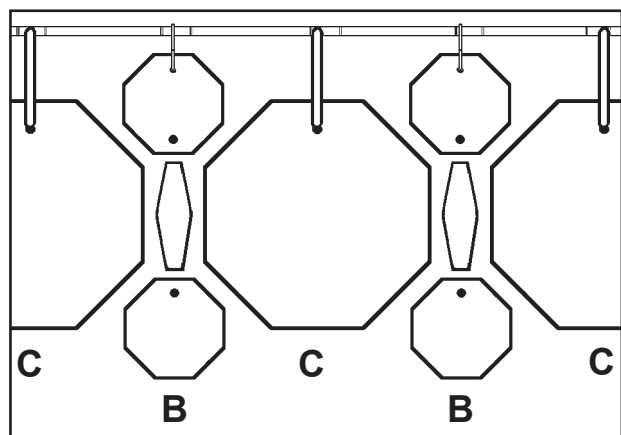

C

B

C

B

36

34

B

32

30

28

B

N21296-**

27

31

C

33

C

35

C

37

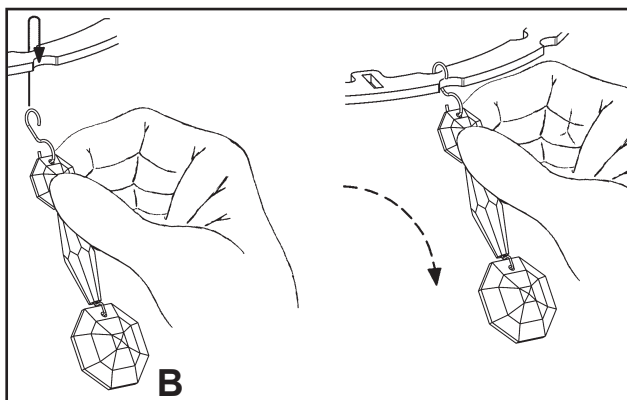

B

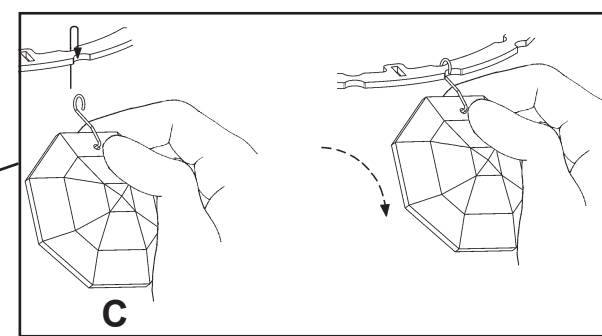

C

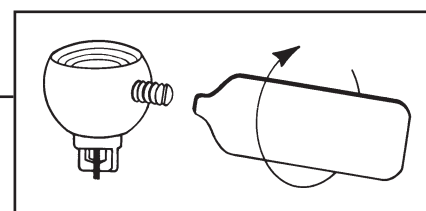

BARONET BN1033N- __ __ R













28 Lights
Diameter: 33"
Height: 27"
Hanging Weight: 60lbs.

THIS DESIGN IS THE PROPRIETARY
TRADE DRESS/TRADEMARK OF
W SCHONBEK LLC.

 **SCHONBEK** | 1870

 **SCHONBEK** | 1870

								
MAX <u>60</u> W	110-120 V							

WARNING:

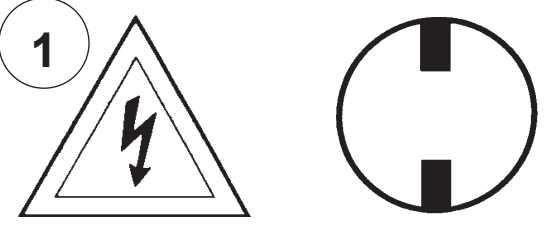

1 Electrical Danger Turn Power Off

All electrical components must be installed by a licensed electrician in accordance with the National Electric Code and the appropriate local electrical codes.

WARNING: THIS LUMINAIRE MUST BE MOUNTED OR SUPPORTED INDEPENDENTLY OF AN OUTLET BOX.

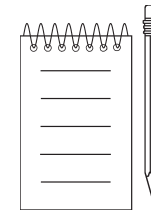
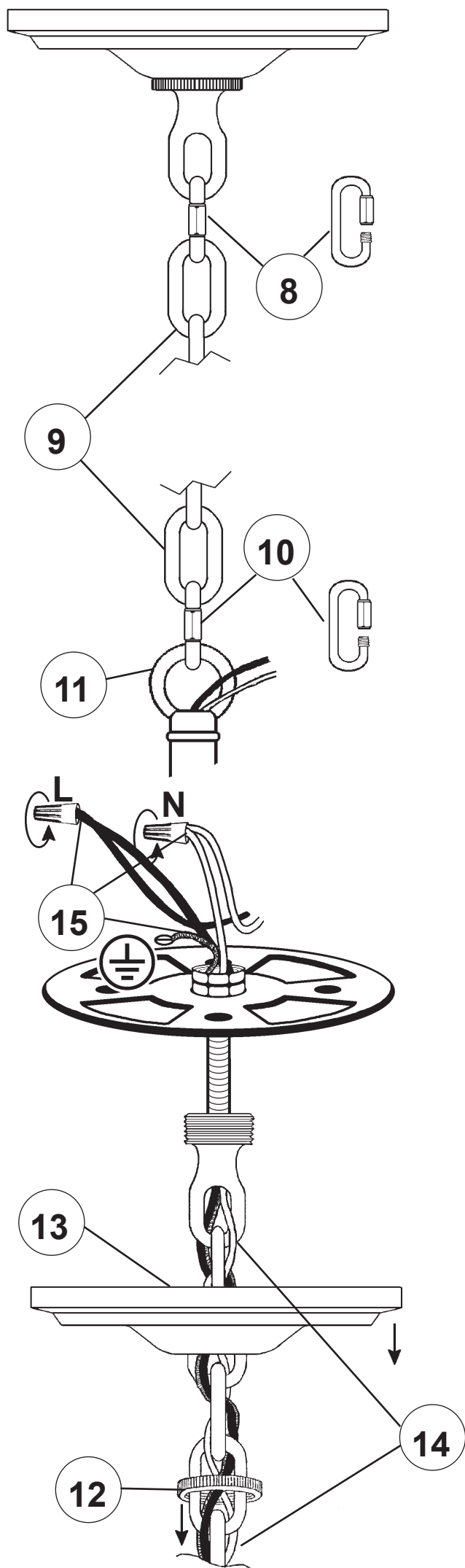
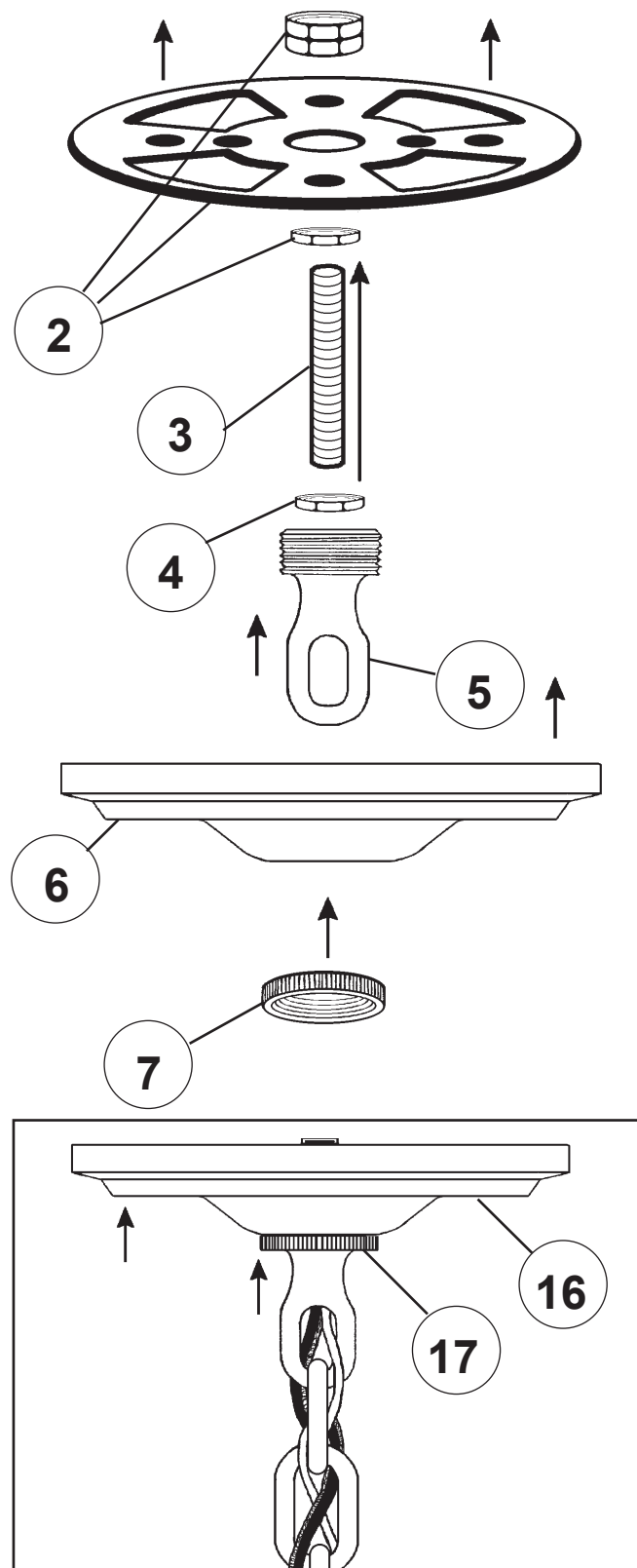

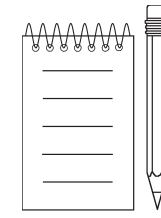
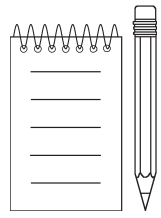

18



You will need 28 - B10
60 Watts Max

Install bulbs and be sure
to test fixture BEFORE
trimming.

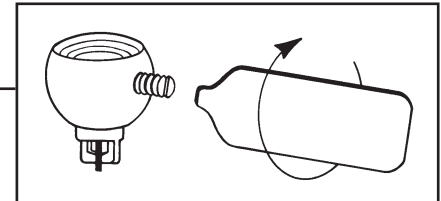
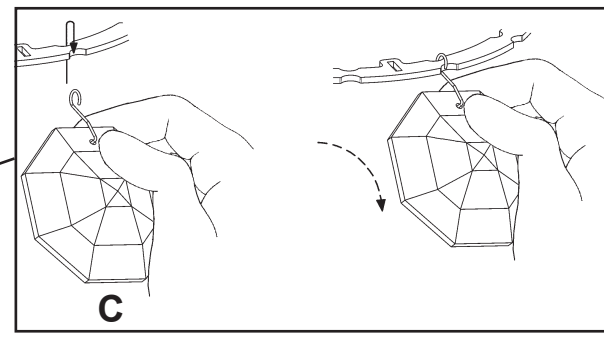
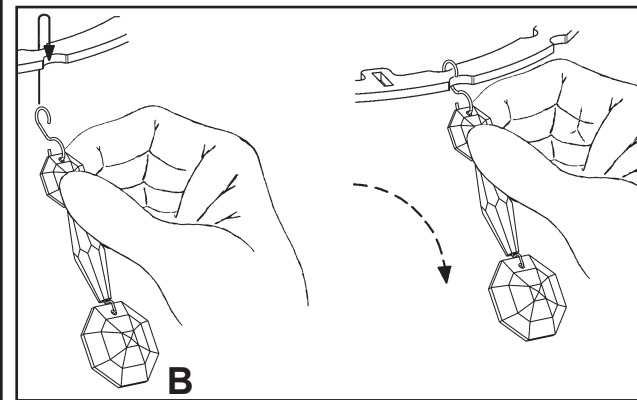
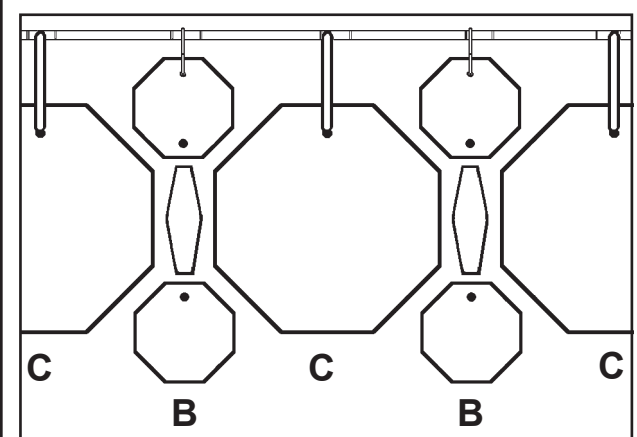
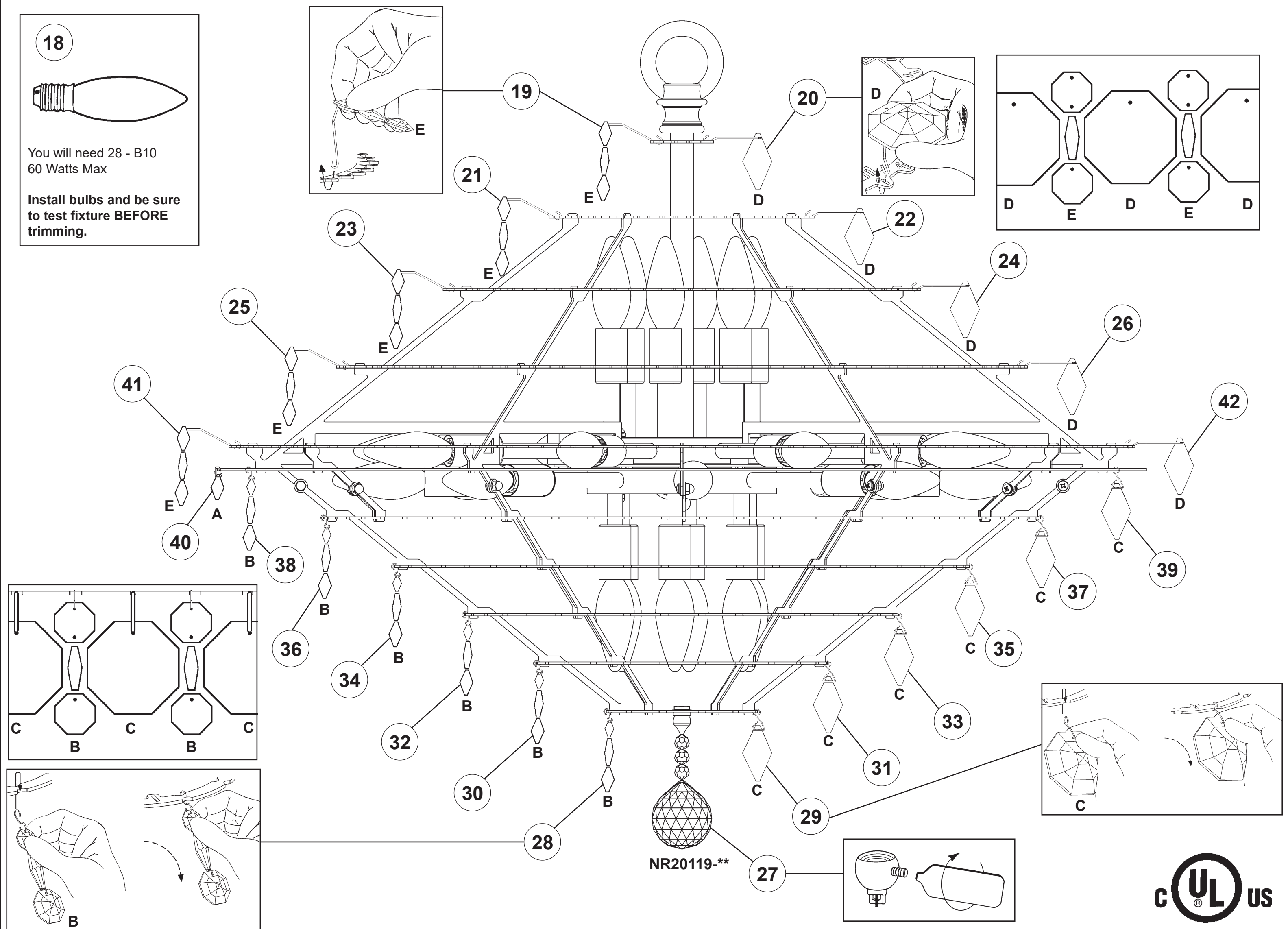
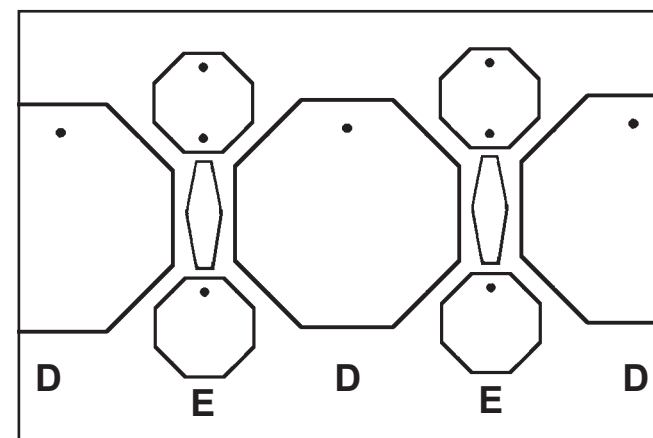
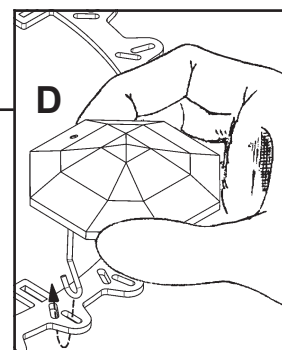
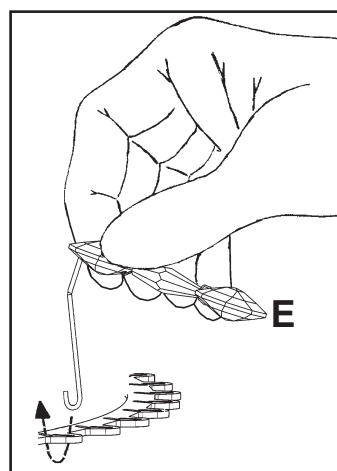

BARONET BN1033N- __ __ S



28 Lights
Diameter: 33"
Height: 27"
Hanging Weight: 60lbs.

THIS DESIGN IS THE PROPRIETARY
TRADE DRESS/TRADEMARK OF
W SCHONBEK LLC.

 **SCHONBEK** | 1870

 **SCHONBEK** | 1870

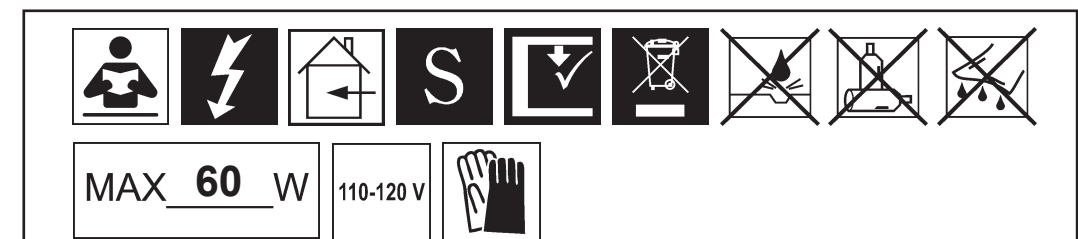

WARNING:

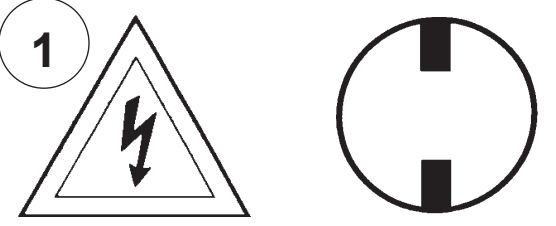
1 

Electrical Danger Turn Power Off

All electrical components must be installed by a licensed electrician in accordance with the National Electric Code and the appropriate local electrical codes.

WARNING: THIS LUMINAIRE MUST BE MOUNTED OR SUPPORTED INDEPENDENTLY OF AN OUTLET BOX.

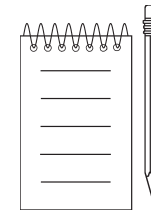
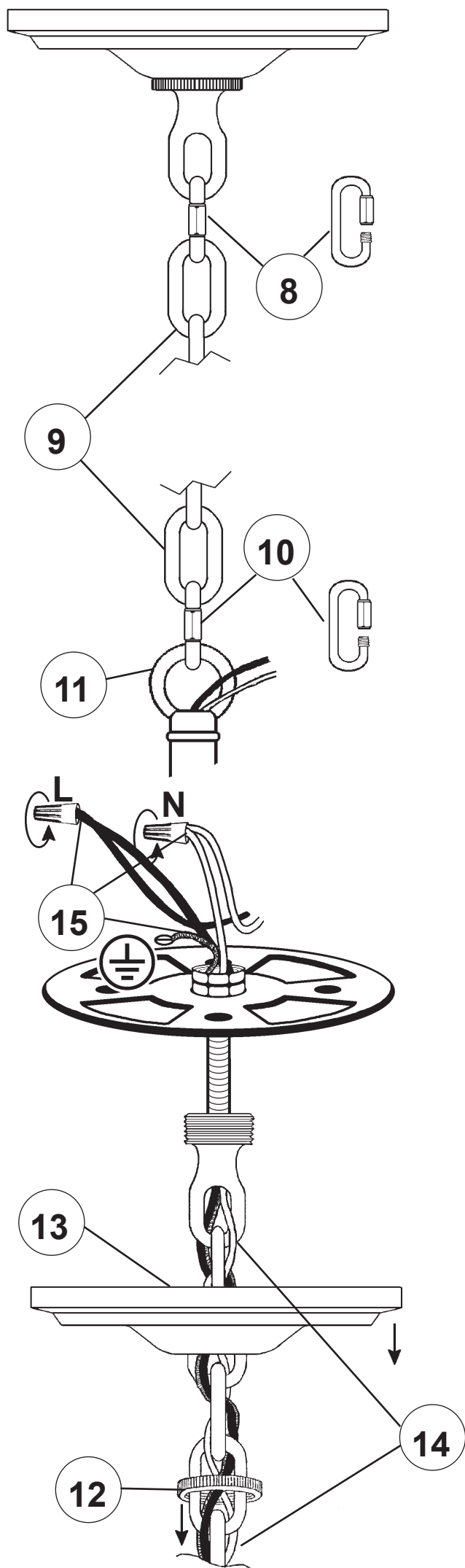
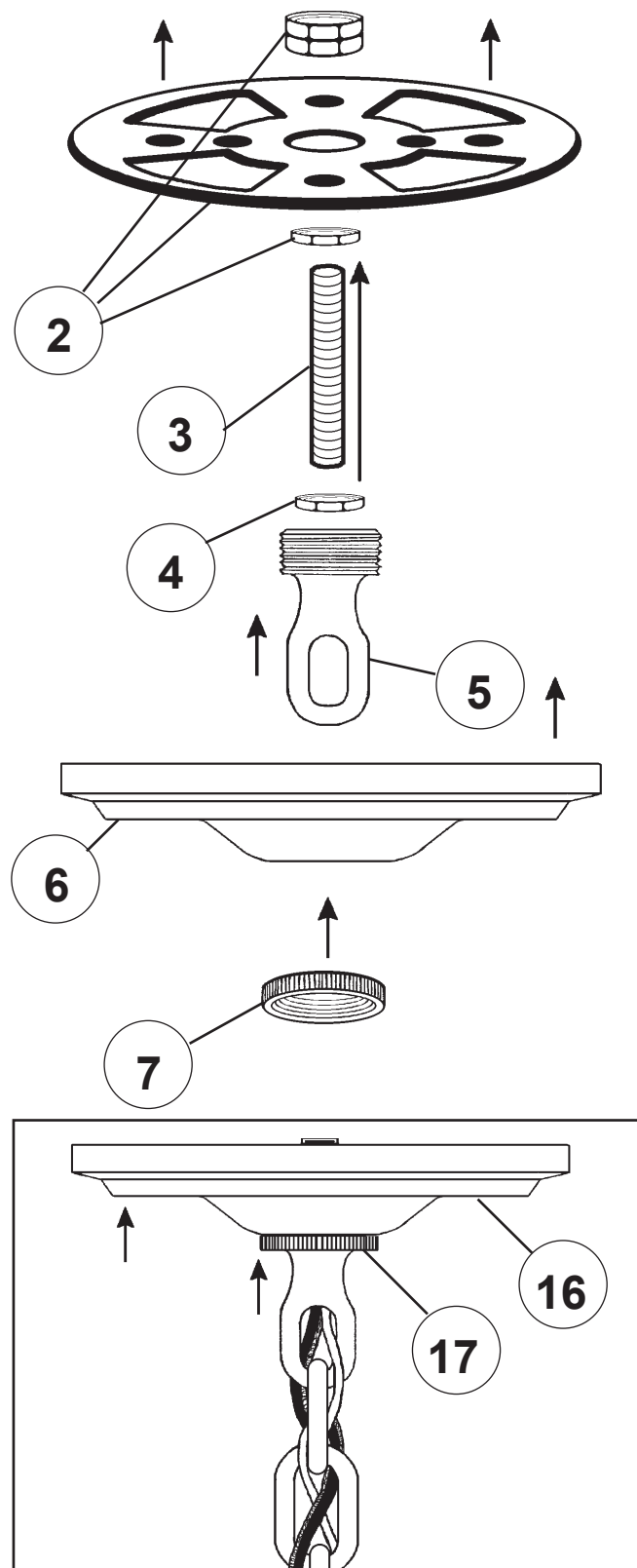

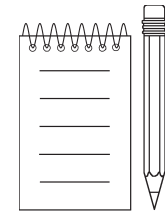

18



You will need 28 - B10
60 Watts Max

Install bulbs and be sure
to test fixture BEFORE
trimming.

