

BARONET BN1416N-__ __O

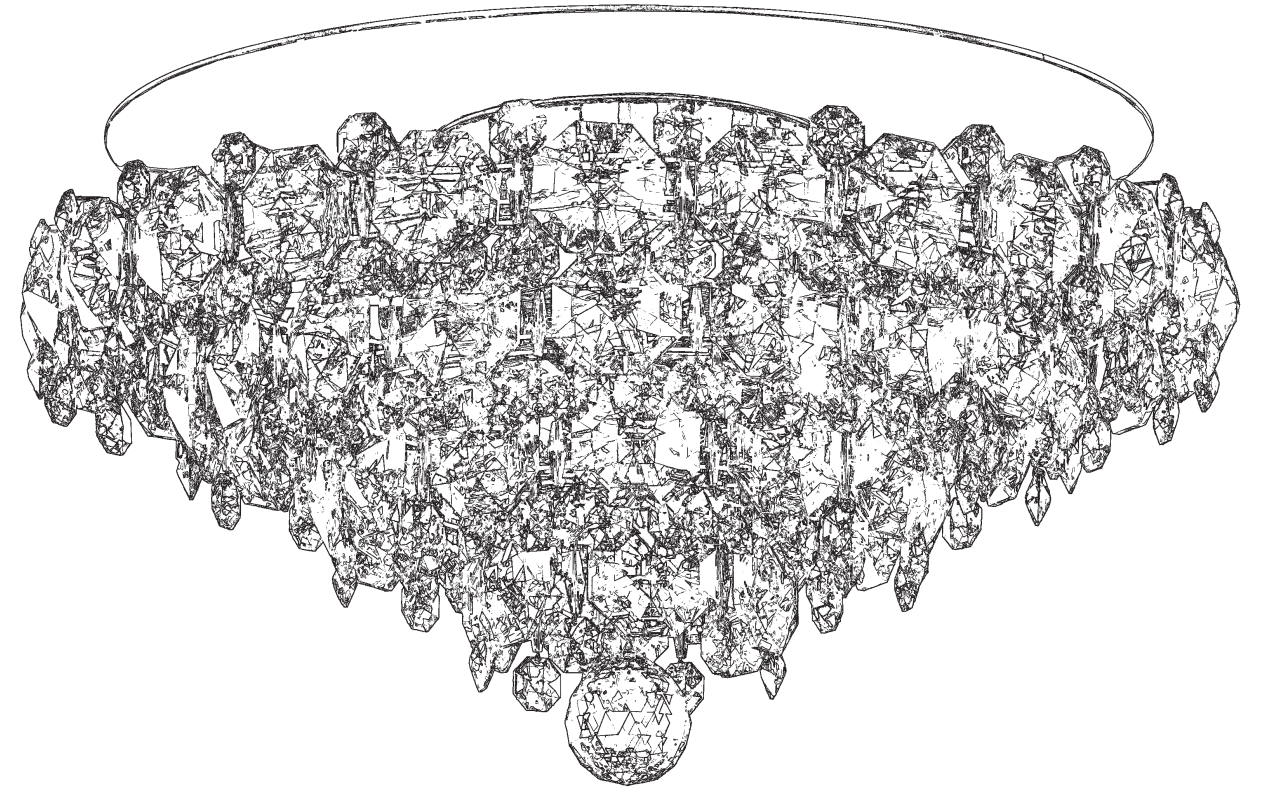











THIS DESIGN IS THE PROPRIETARY
TRADE DRESS/TRADEMARK OF
W SCHONBEK LLC.

4 Lights
Diameter: 19"
Height: 11"
Hanging Weight: 20lbs.

 **SCHONBEK** | 1870

 **SCHONBEK** | 1870

								
MAX <u>40</u> W	110-120 V							

WARNING:

1

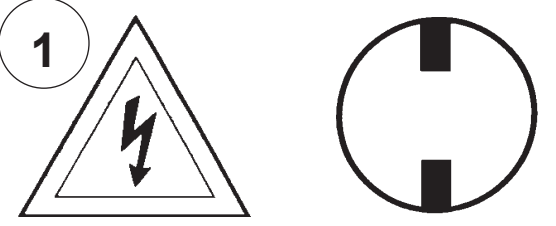

Electrical Danger **Turn Power Off**

All electrical components must be installed by a licensed electrician in accordance with the National Electric Code and the appropriate local electrical codes.

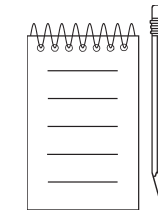
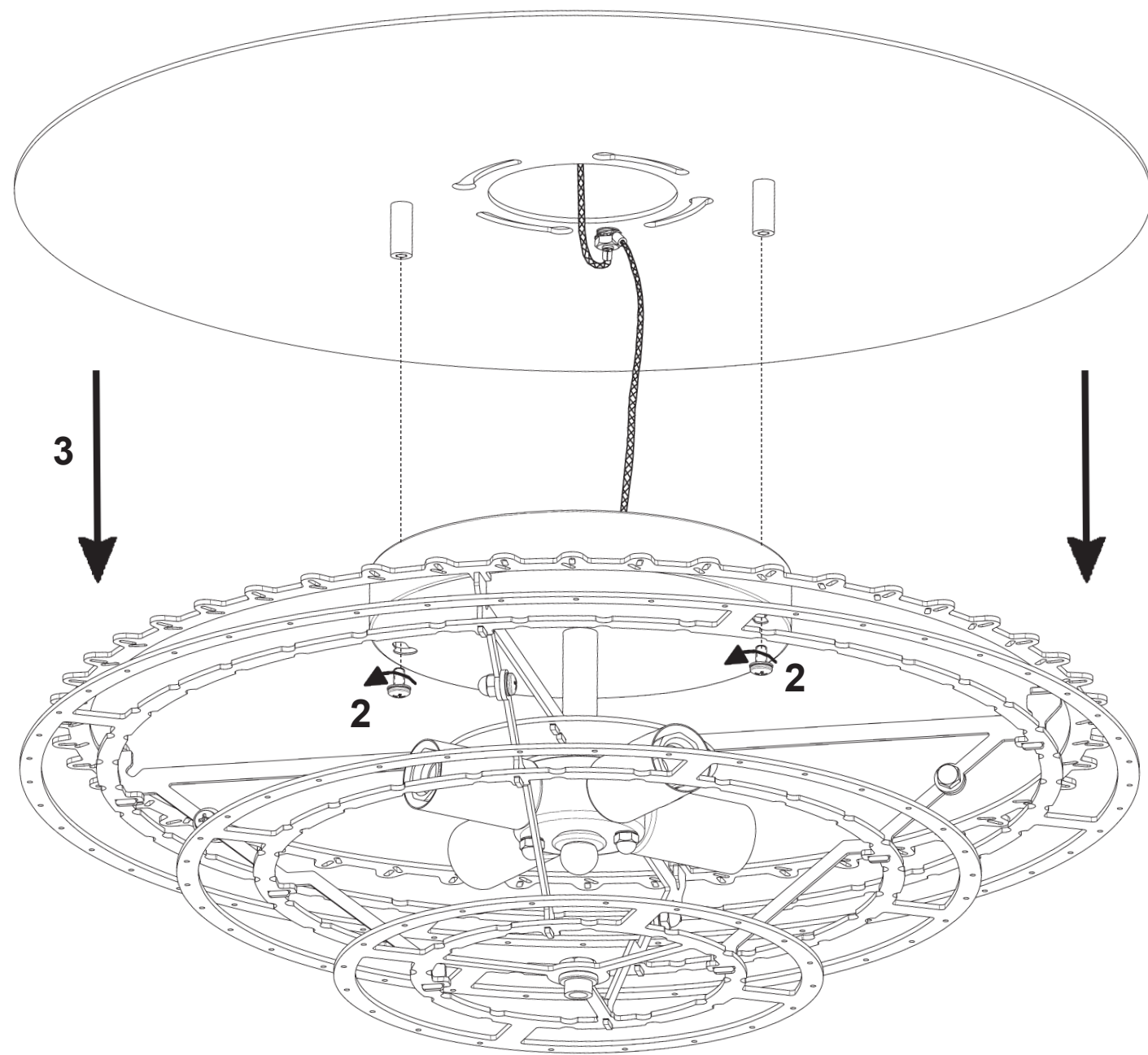

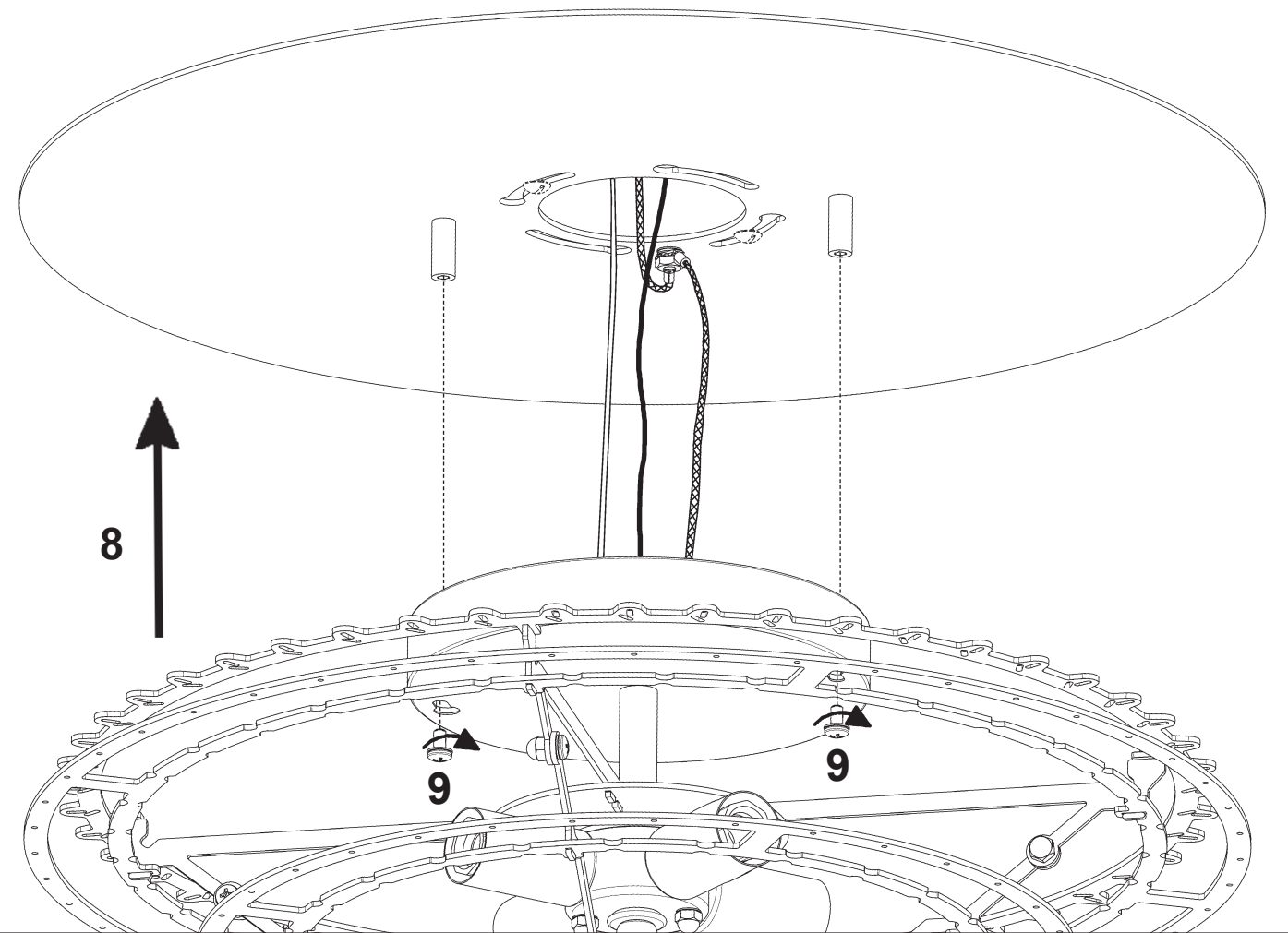
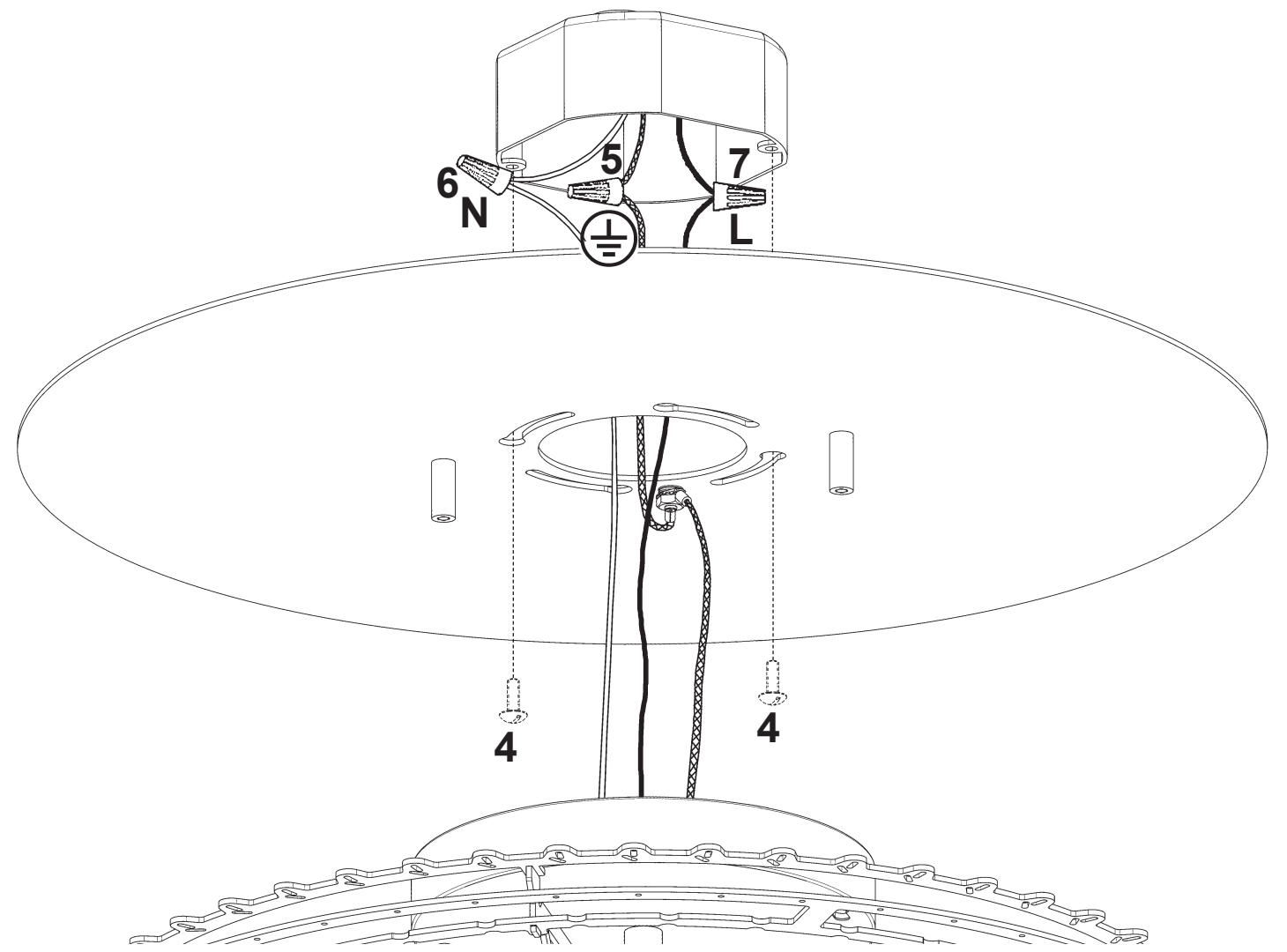
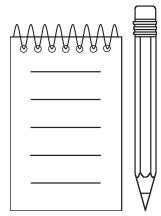

10

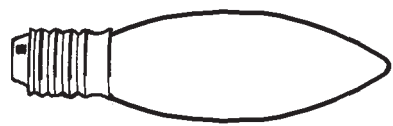

You will need 4 - B10
40 Watts Max

Install bulbs and be sure
to test fixture **BEFORE**
trimming.

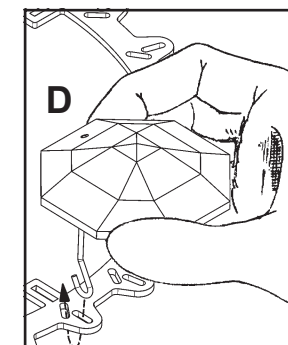
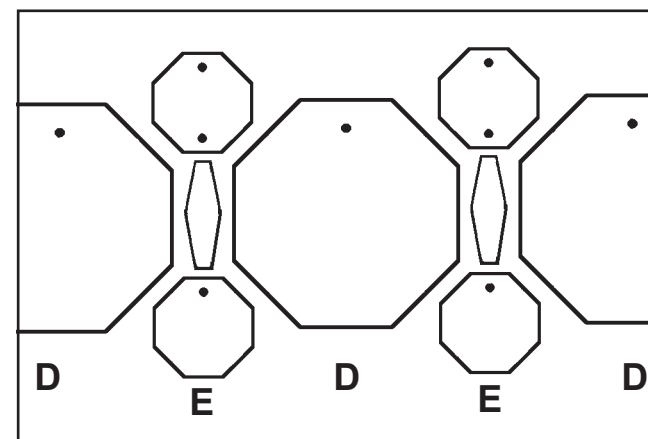

22

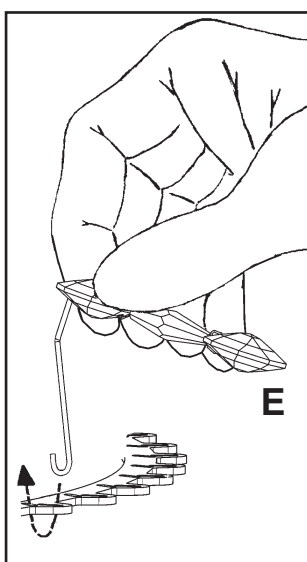

21



20



18



17



15



14



12

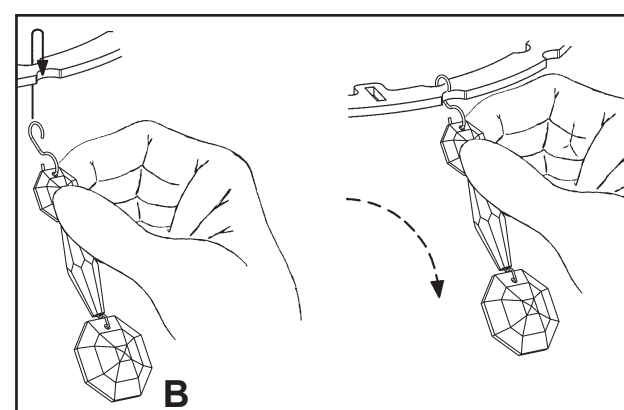
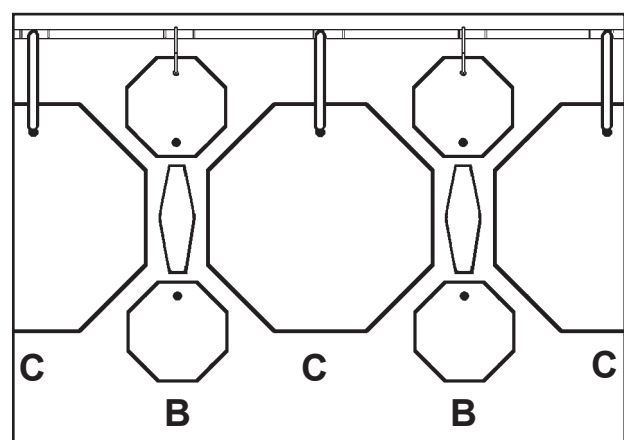

B

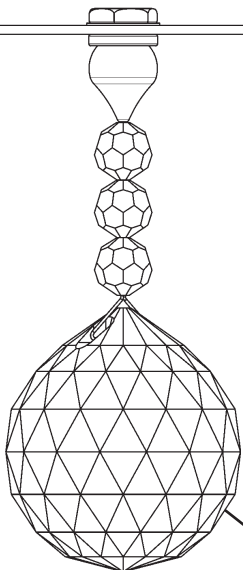
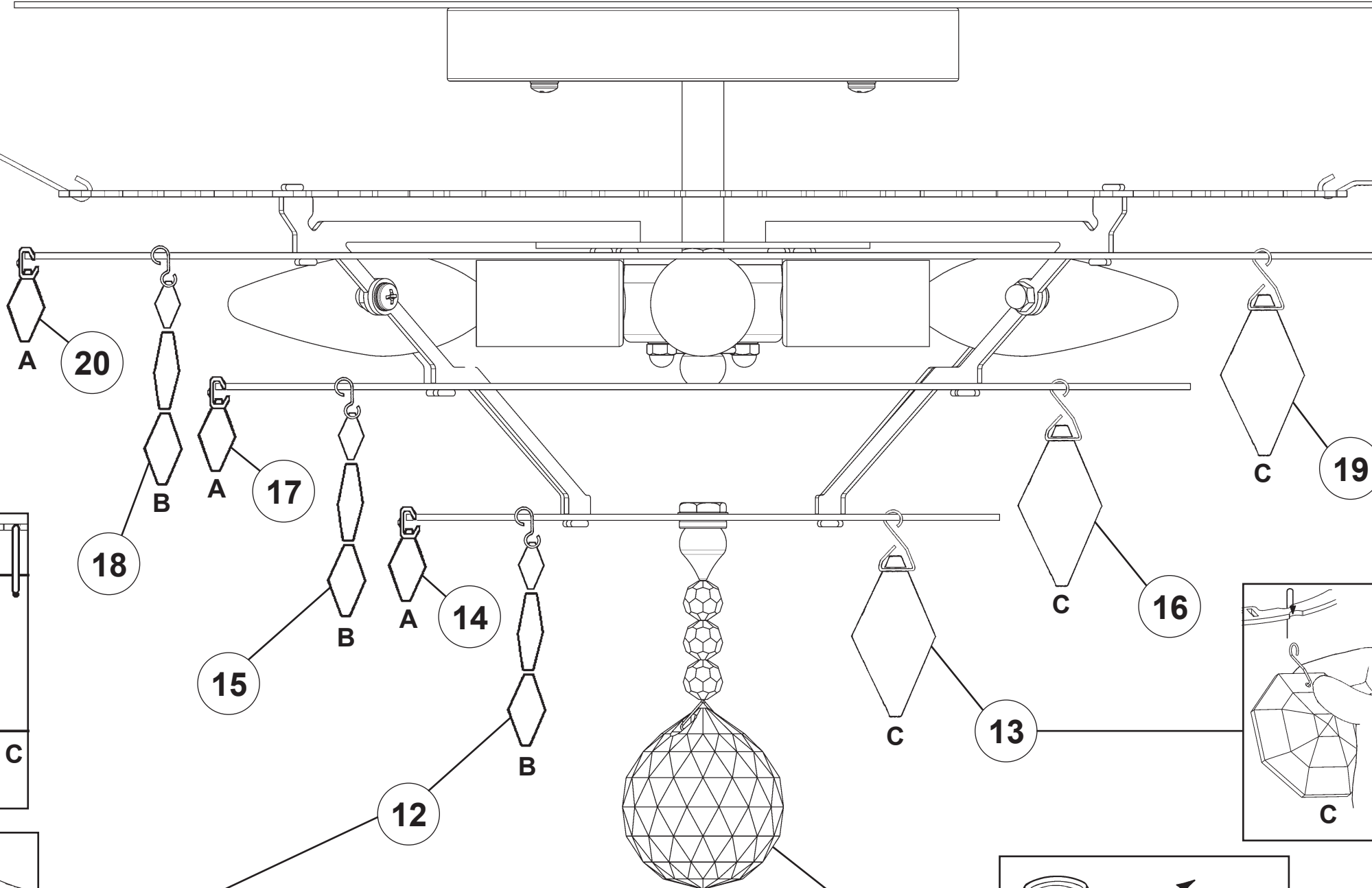

11

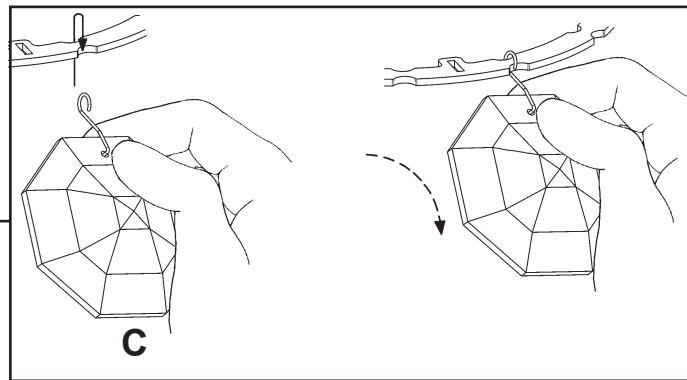
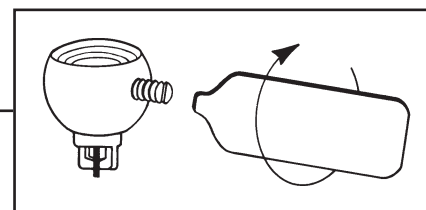

C



19



16



13



BARONET BN1416N- __ __ R

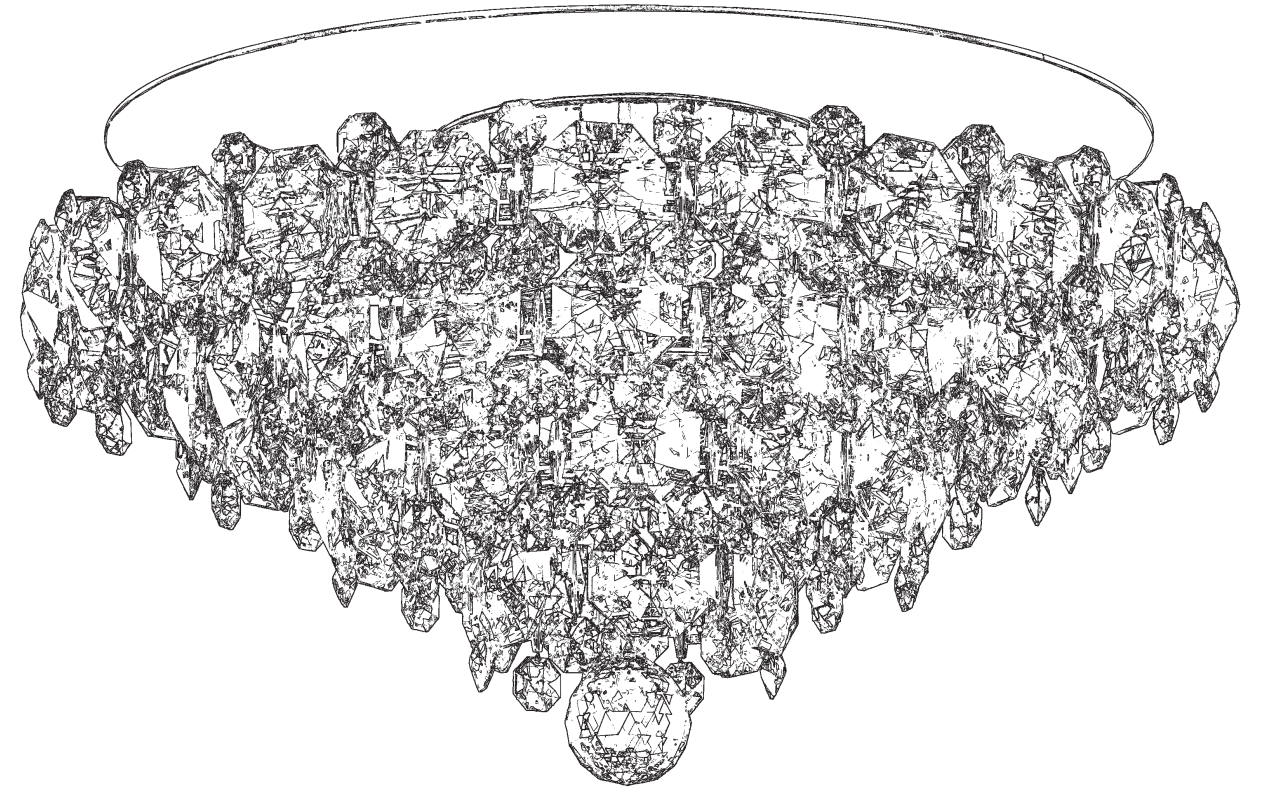











4 Lights
Diameter: 19"
Height: 11"
Hanging Weight: 20lbs.

THIS DESIGN IS THE PROPRIETARY
TRADE DRESS/TRADEMARK OF
W SCHONBEK LLC.

 **SCHONBEK** | 1870

 **SCHONBEK** | 1870

								
MAX <u>40</u> W	110-120 V							

WARNING:

1

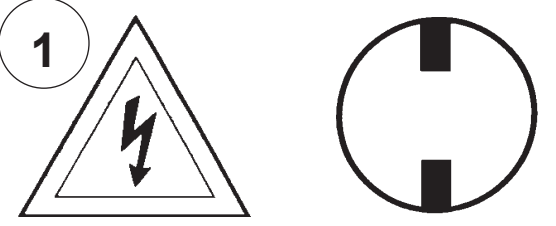

Electrical Danger **Turn Power Off**

All electrical components must be installed by a licensed electrician in accordance with the National Electric Code and the appropriate local electrical codes.

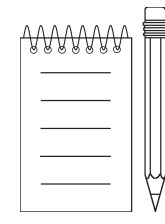
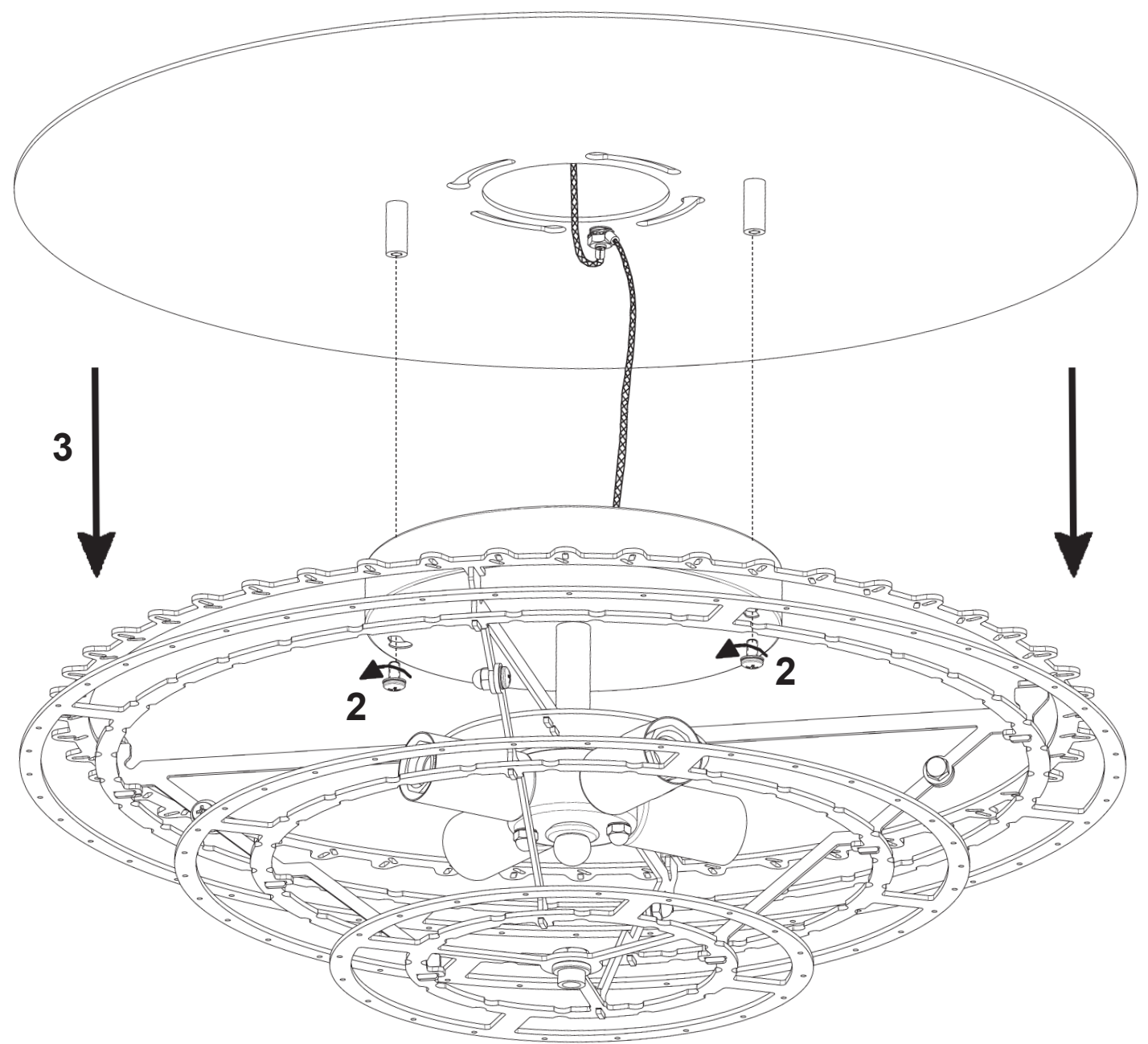

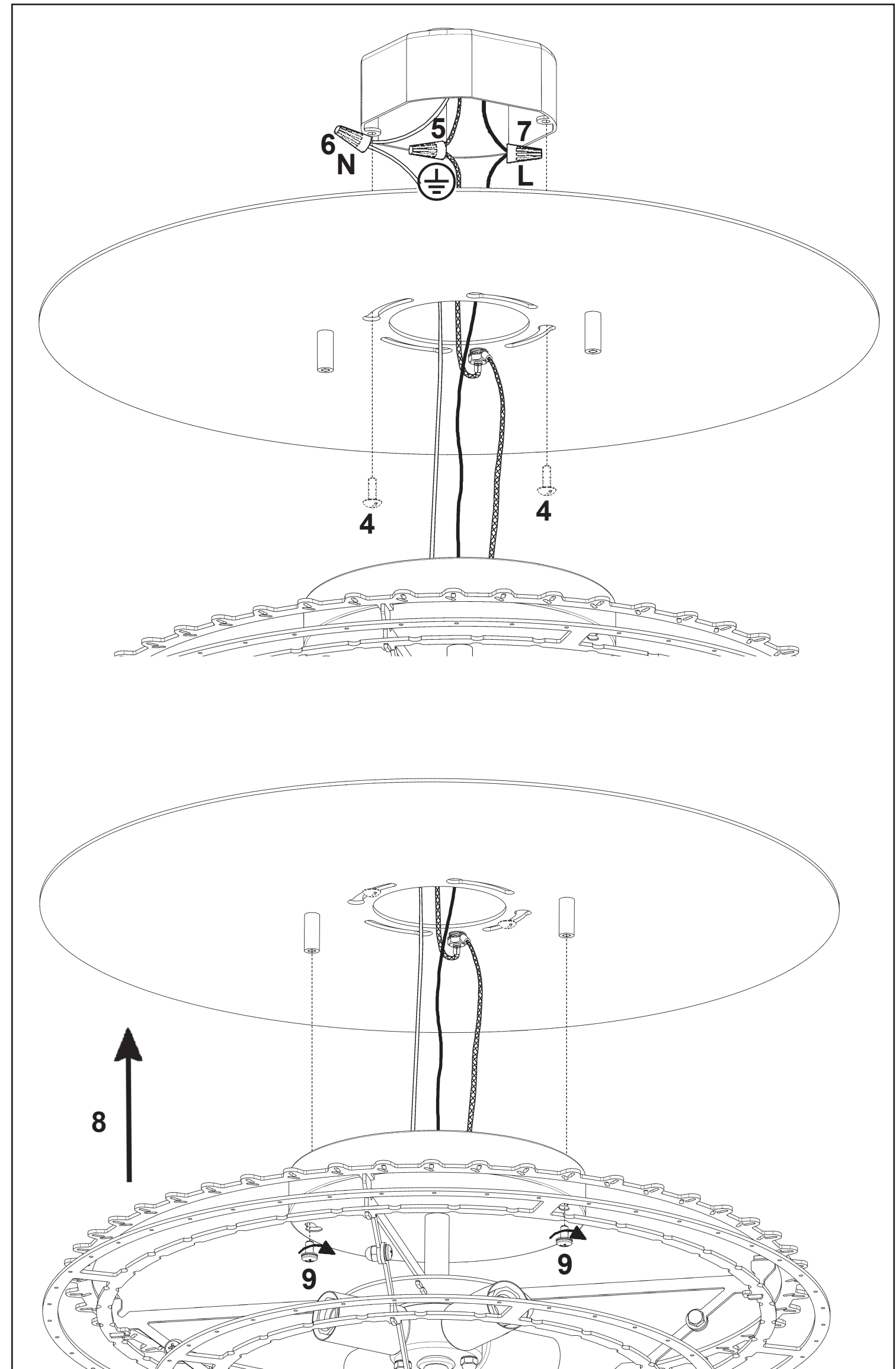
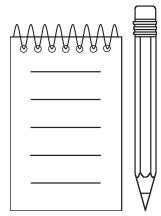

10

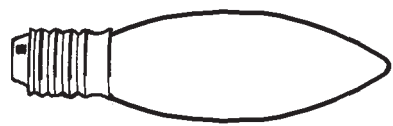

You will need 4 - B10
40 Watts Max

Install bulbs and be sure
to test fixture **BEFORE**
trimming.

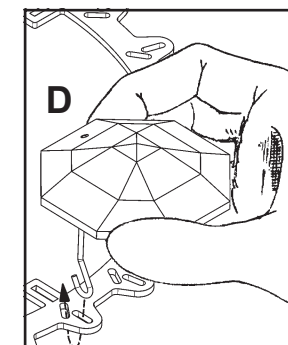
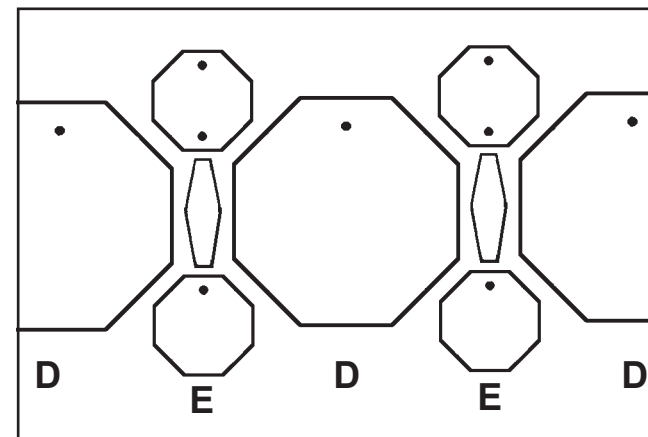

22

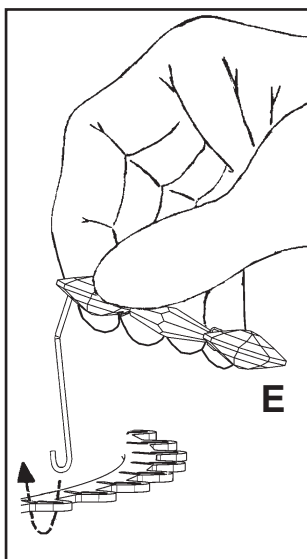

21



20



17



14

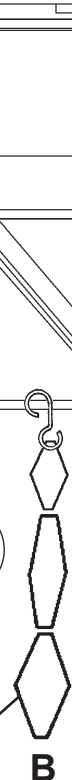

15

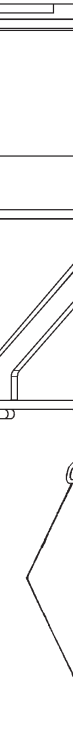

13



16



19

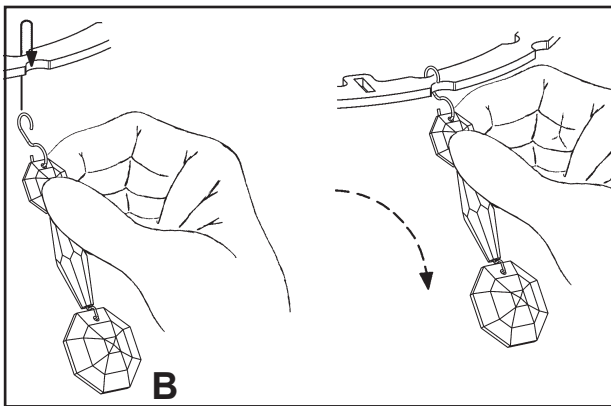
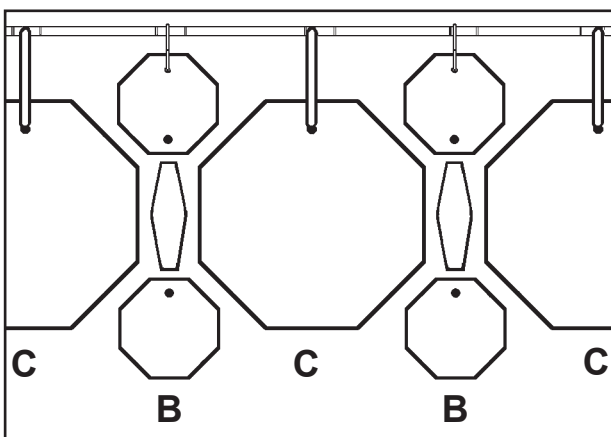

B

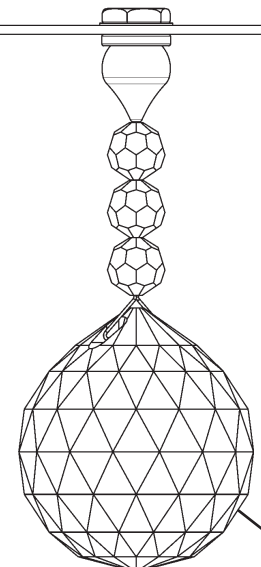

NR20119-**.11

11

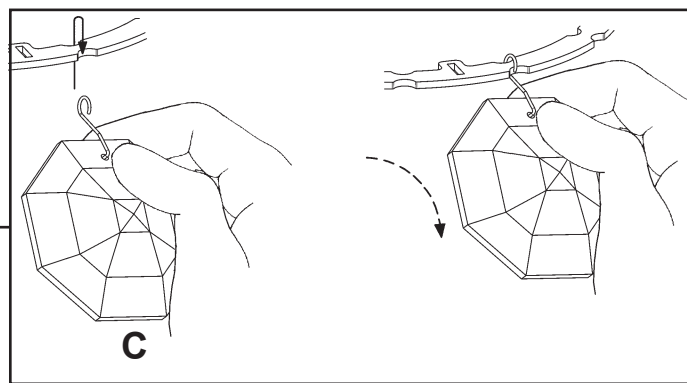
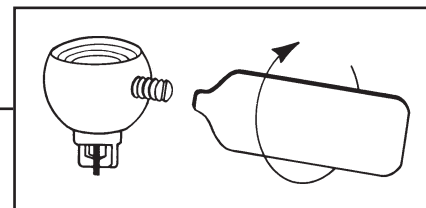

C



BARONET BN1416N- __ __ S

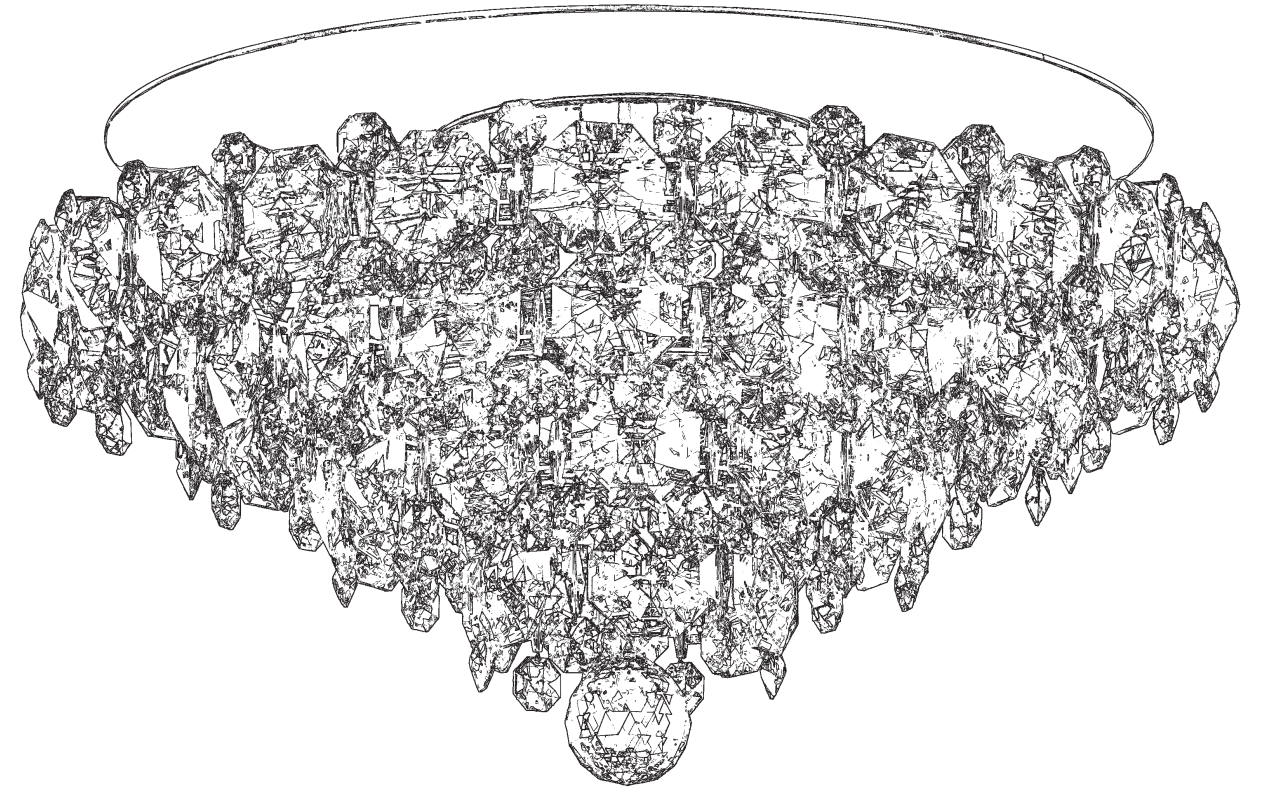











THIS DESIGN IS THE PROPRIETARY
TRADE DRESS/TRADEMARK OF
W SCHONBEK LLC.

4 Lights
Diameter: 19"
Height: 11"
Hanging Weight: 20lbs.

 **SCHONBEK** | 1870

 **SCHONBEK** | 1870

								
MAX <u>40</u> W	110-120 V							

WARNING:

1

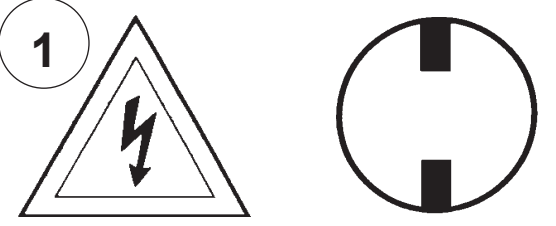

Electrical Danger **Turn Power Off**

All electrical components must be installed by a licensed electrician in accordance with the National Electric Code and the appropriate local electrical codes.

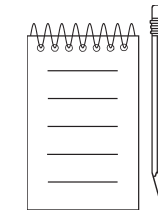
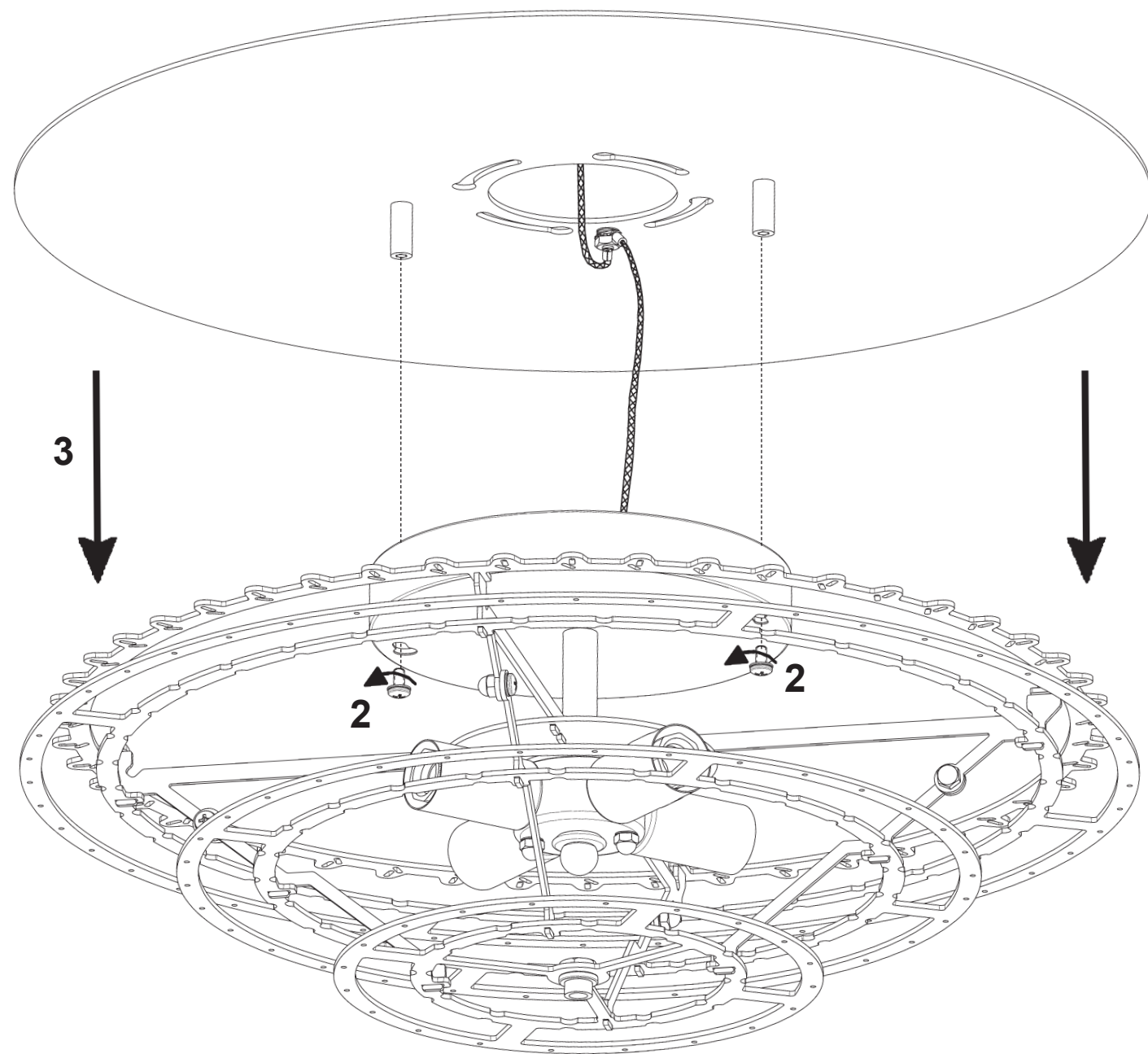

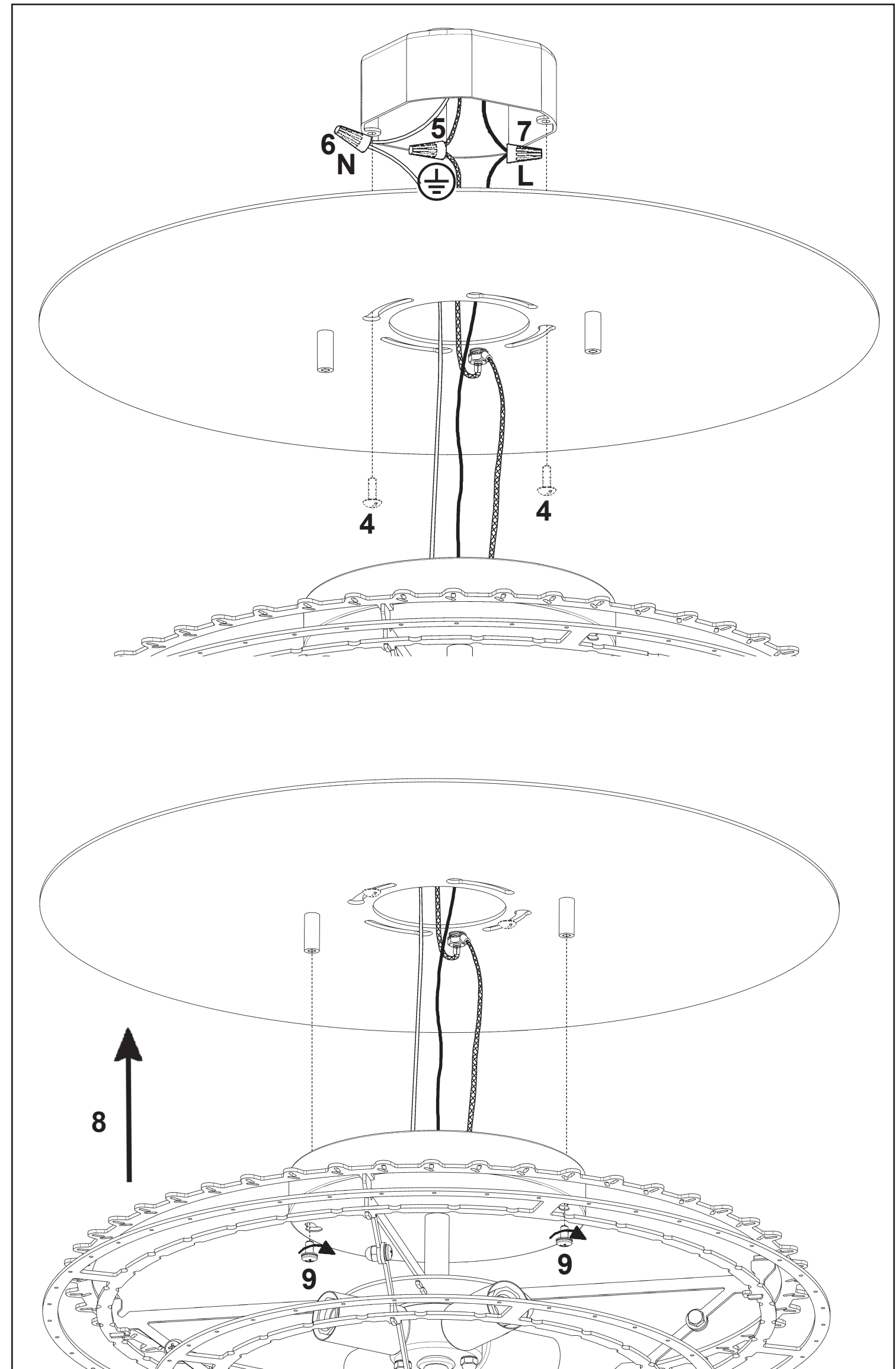
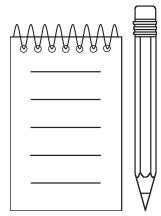

10

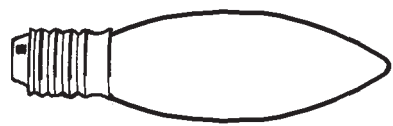

You will need 4 - B10
40 Watts Max

Install bulbs and be sure
to test fixture **BEFORE**
trimming.

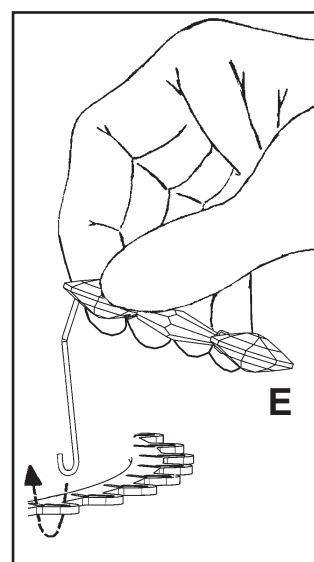
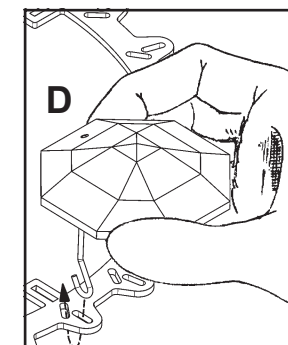
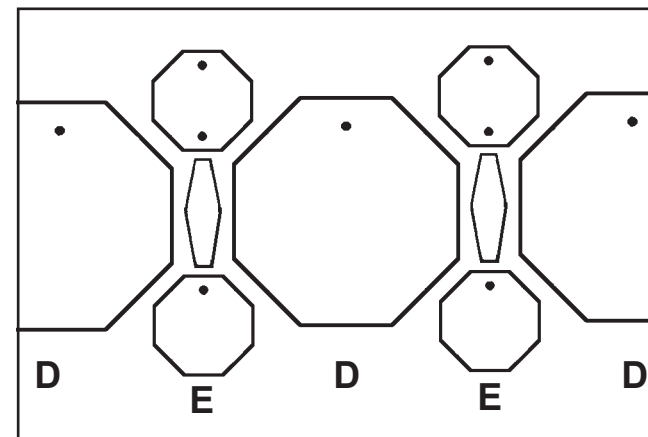

21



20



17



14

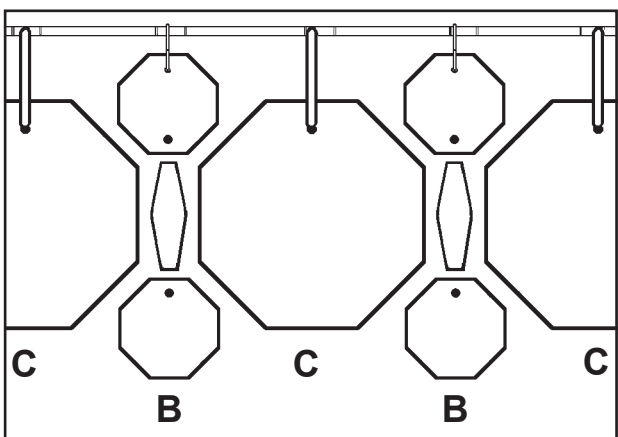

C

B

B

C

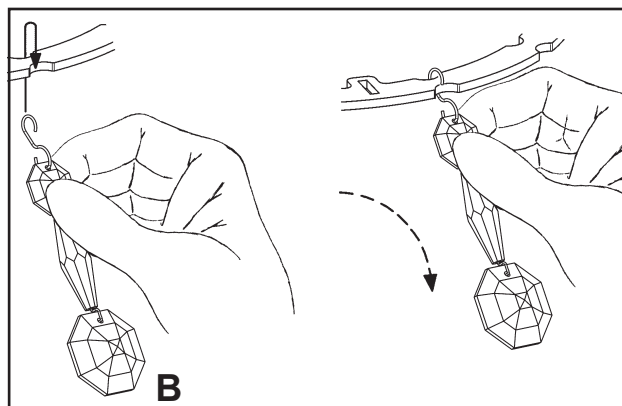

B

12

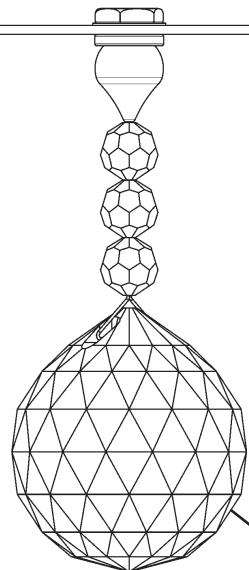

N20119-**

11

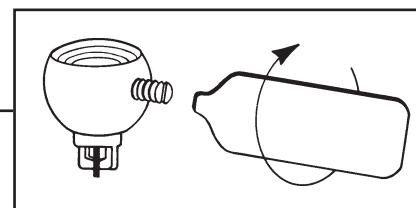

C

19



C

16



C

13

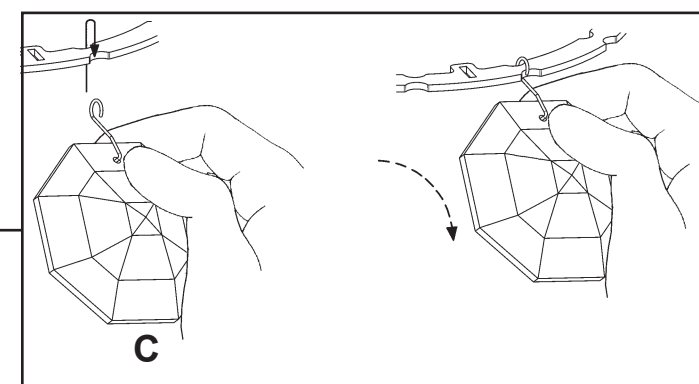

C

22



D

