

BARONET BN1424N-__ __O

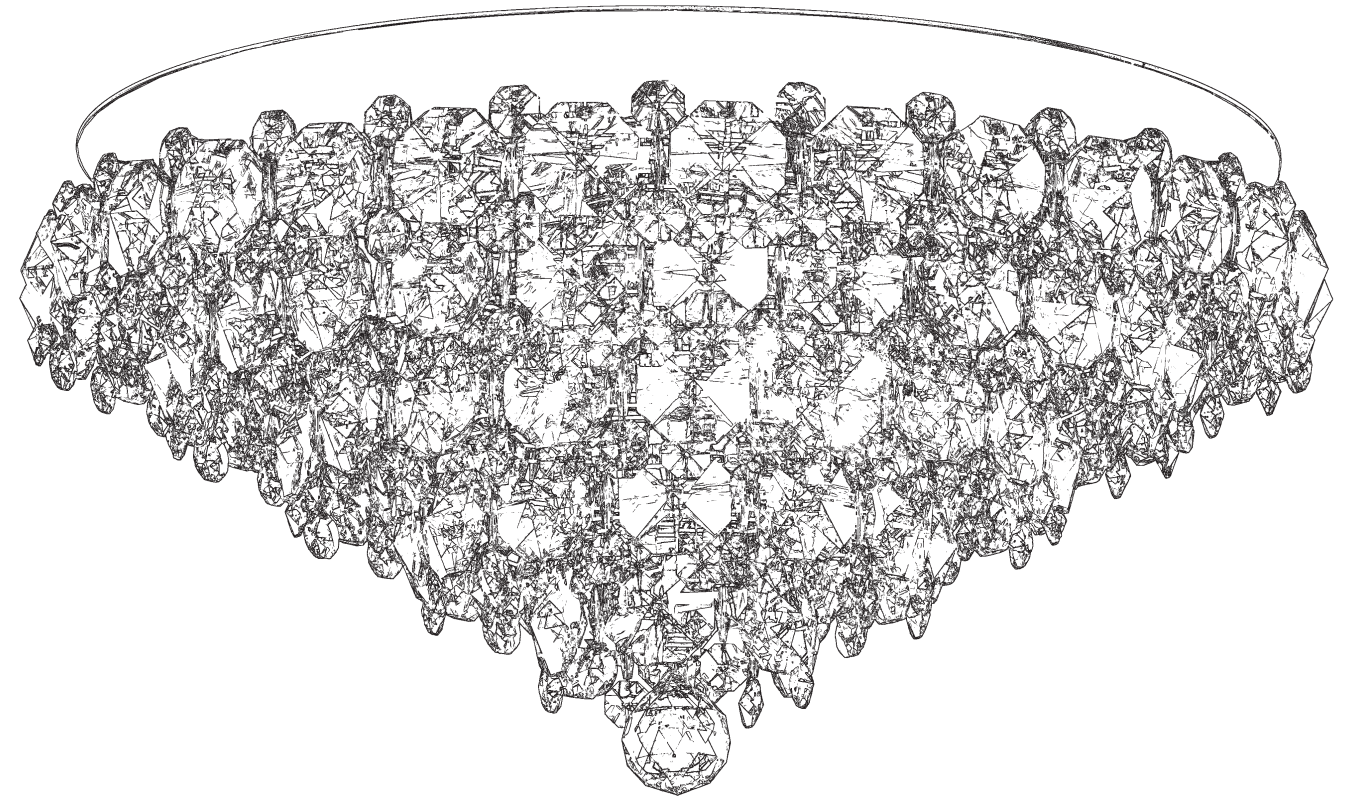











THIS DESIGN IS THE PROPRIETARY TRADE DRESS/TRADEMARK OF W SCHONBEK LLC.

6 Lights
Diameter: 24"
Height: 12"
Hanging Weight: 32lbs.

 **SCHONBEK** | 1870

 **SCHONBEK** | 1870

								
MAX <u>40</u> W	110-120 V							

WARNING:

1

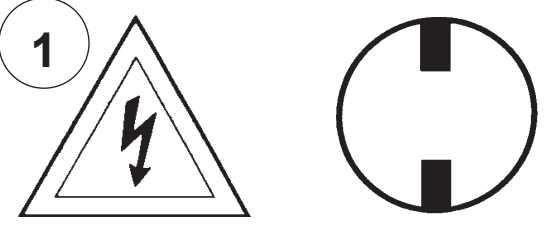

Electrical Danger **Turn Power Off**

All electrical components must be installed by a licensed electrician in accordance with the National Electric Code and the appropriate local electrical codes.

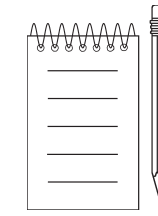
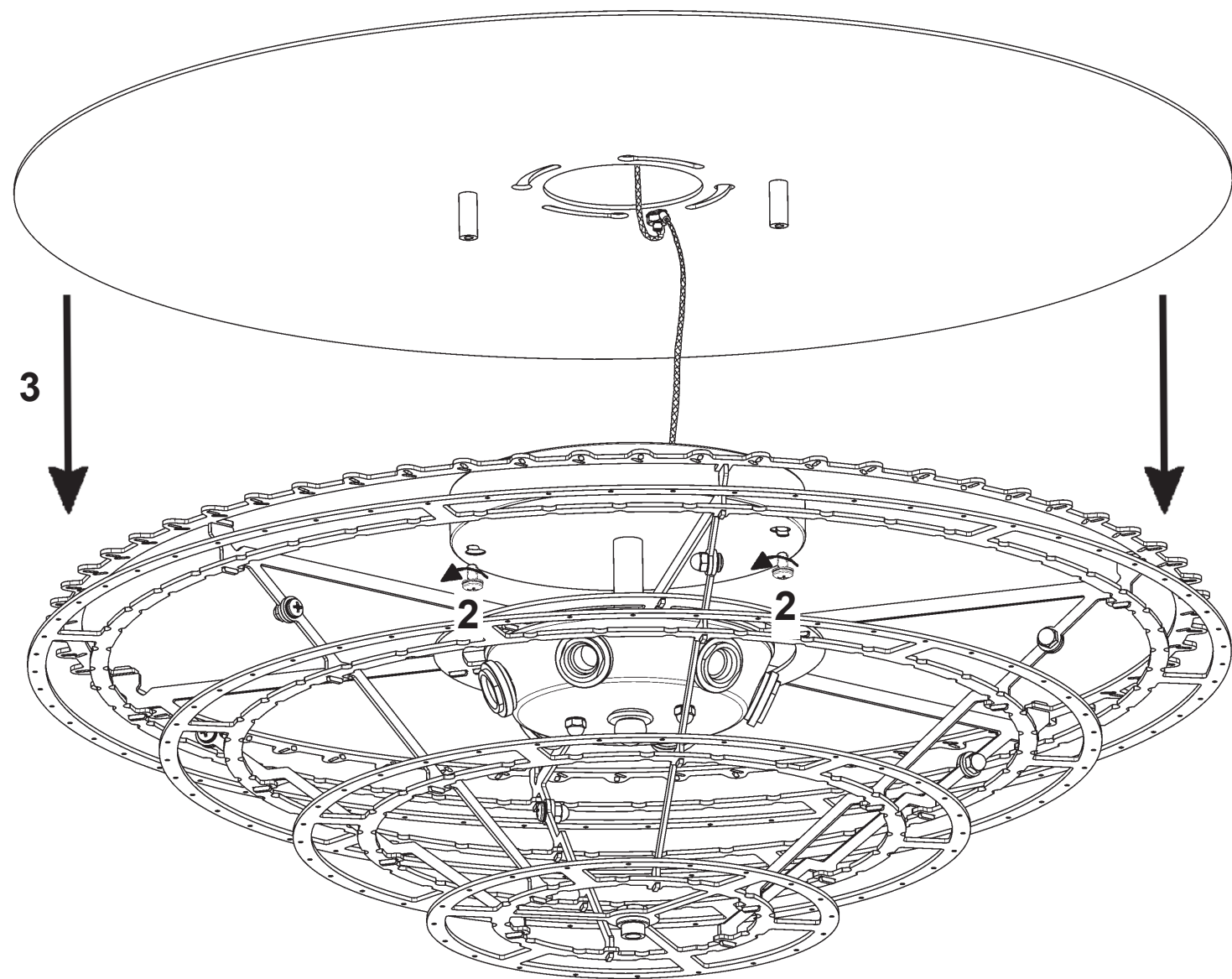

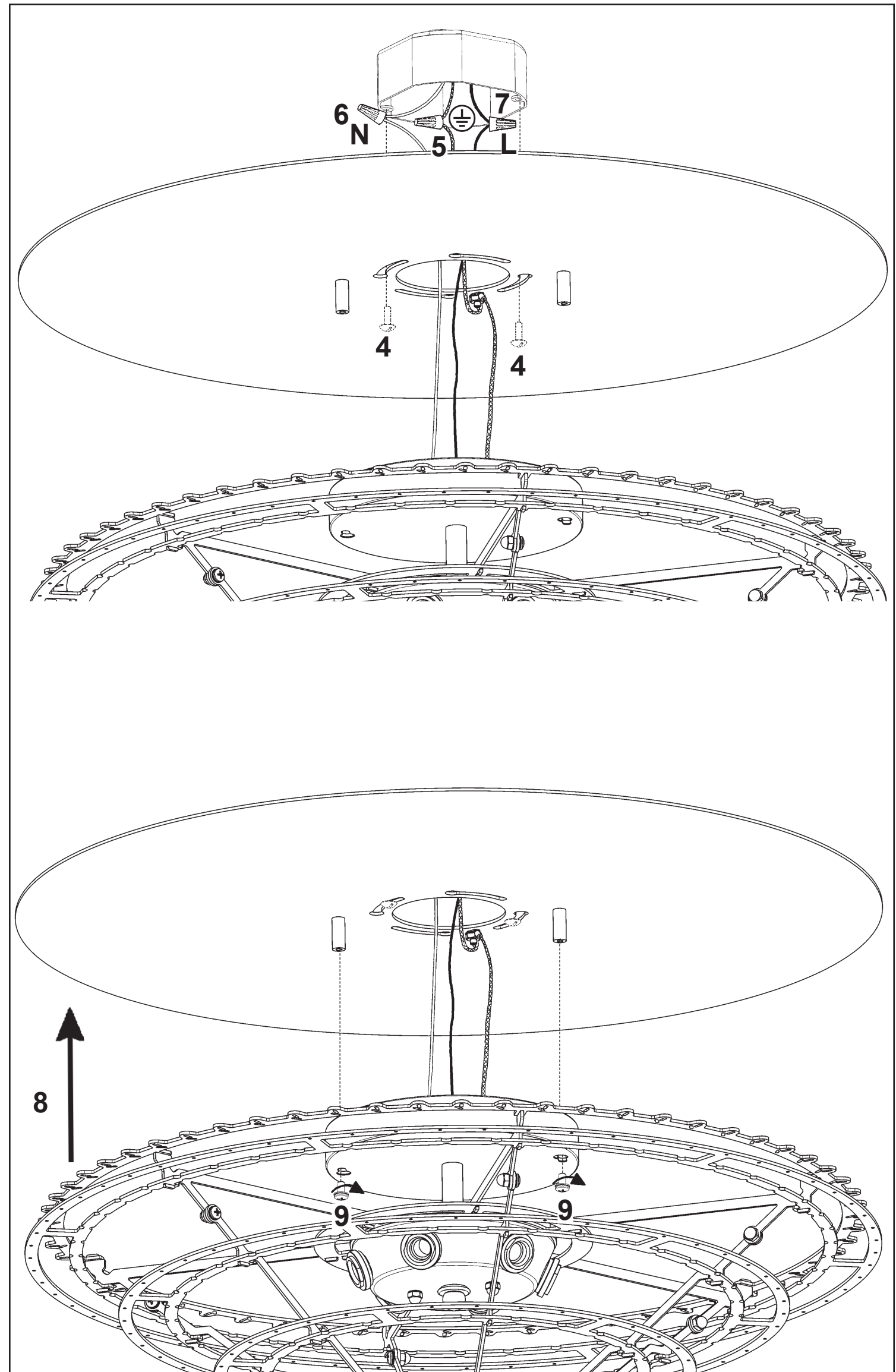

10

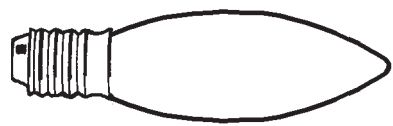

You will need 6 - B10
40 Watts Max

Install bulbs and be sure
to test fixture **BEFORE**
trimming.

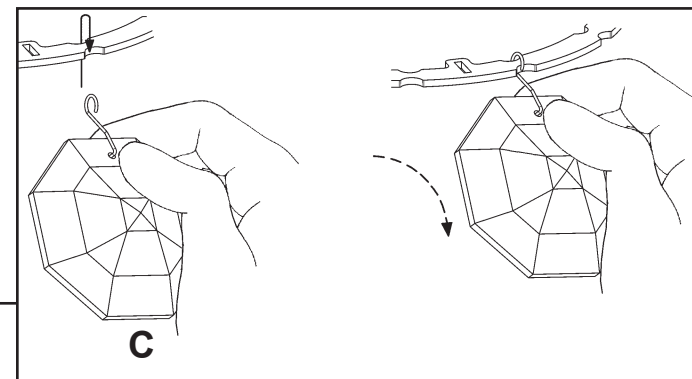
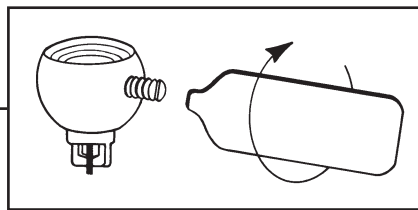
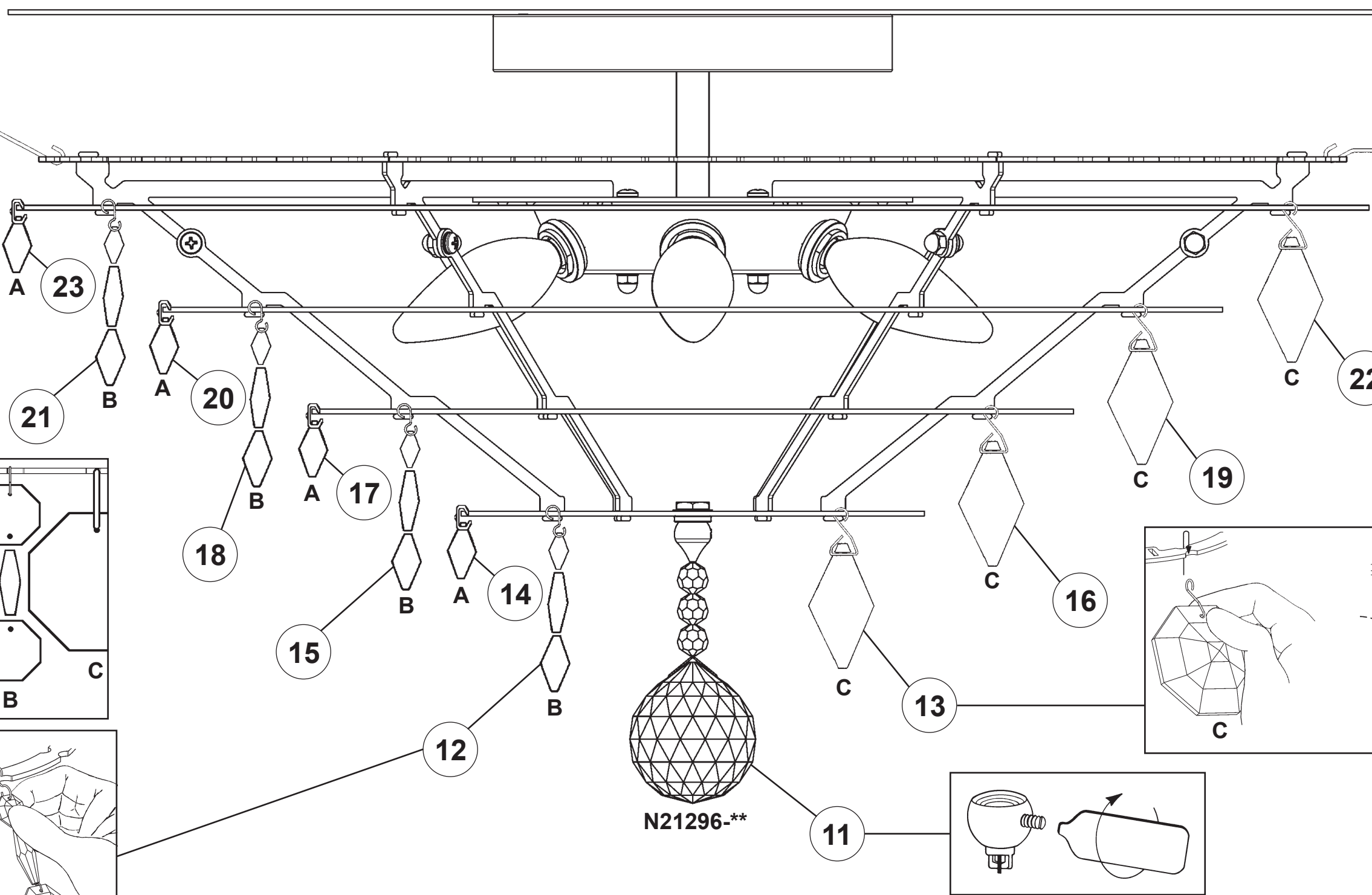
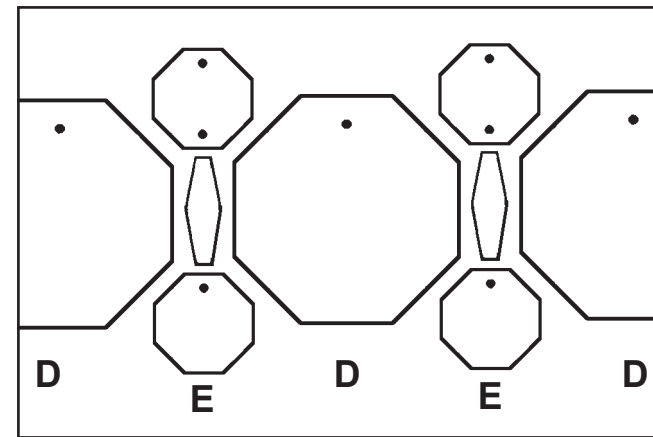
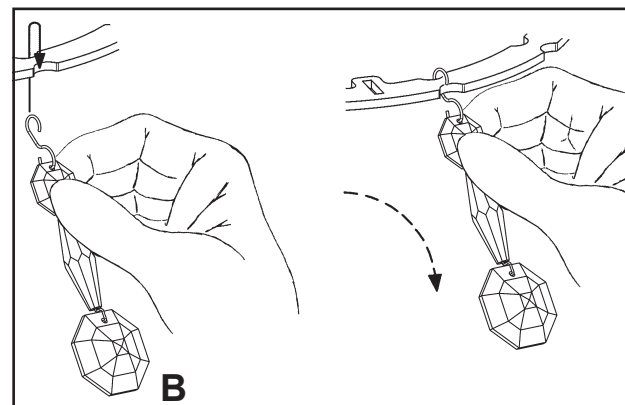
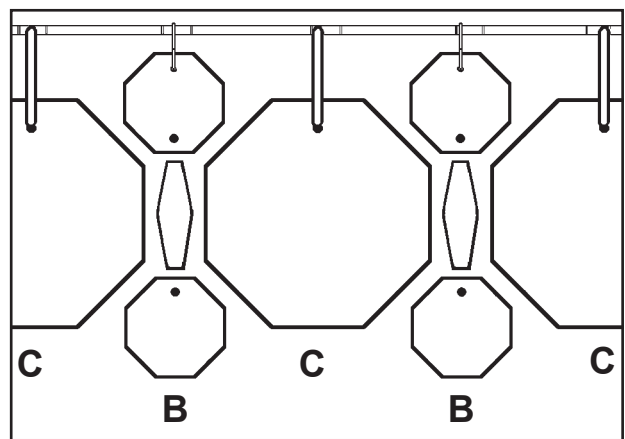
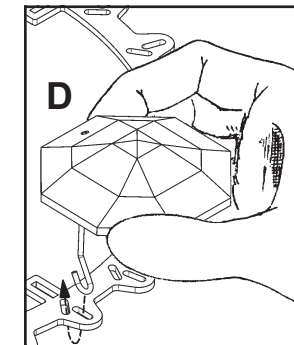
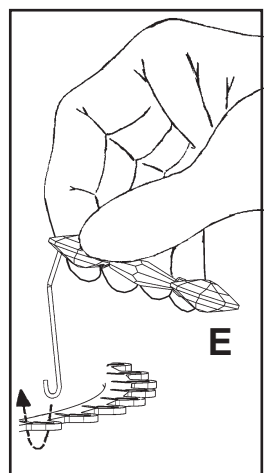

BARONET BN1424N-__ __R

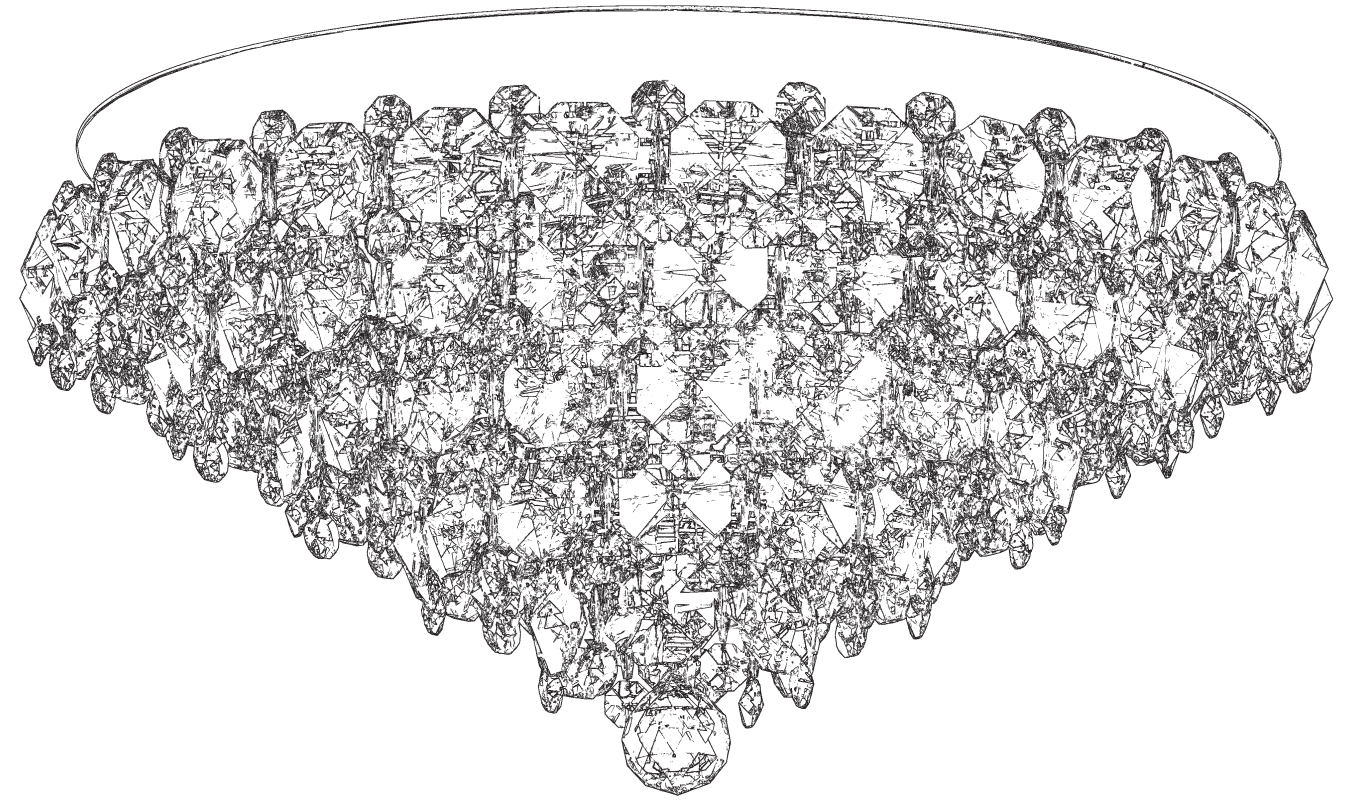











6 Lights
Diameter: 24"
Height: 12"
Hanging Weight: 32lbs.

THIS DESIGN IS THE PROPRIETARY
TRADE DRESS/TRADEMARK OF
W SCHONBEK LLC.

 **SCHONBEK** | 1870

 **SCHONBEK** | 1870

								
MAX <u>40</u> W	110-120 V							

WARNING:

1

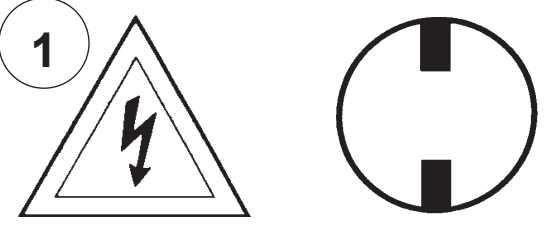

Electrical Danger **Turn Power Off**

All electrical components must be installed by a licensed electrician in accordance with the National Electric Code and the appropriate local electrical codes.

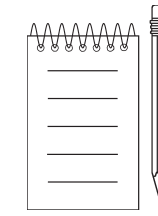
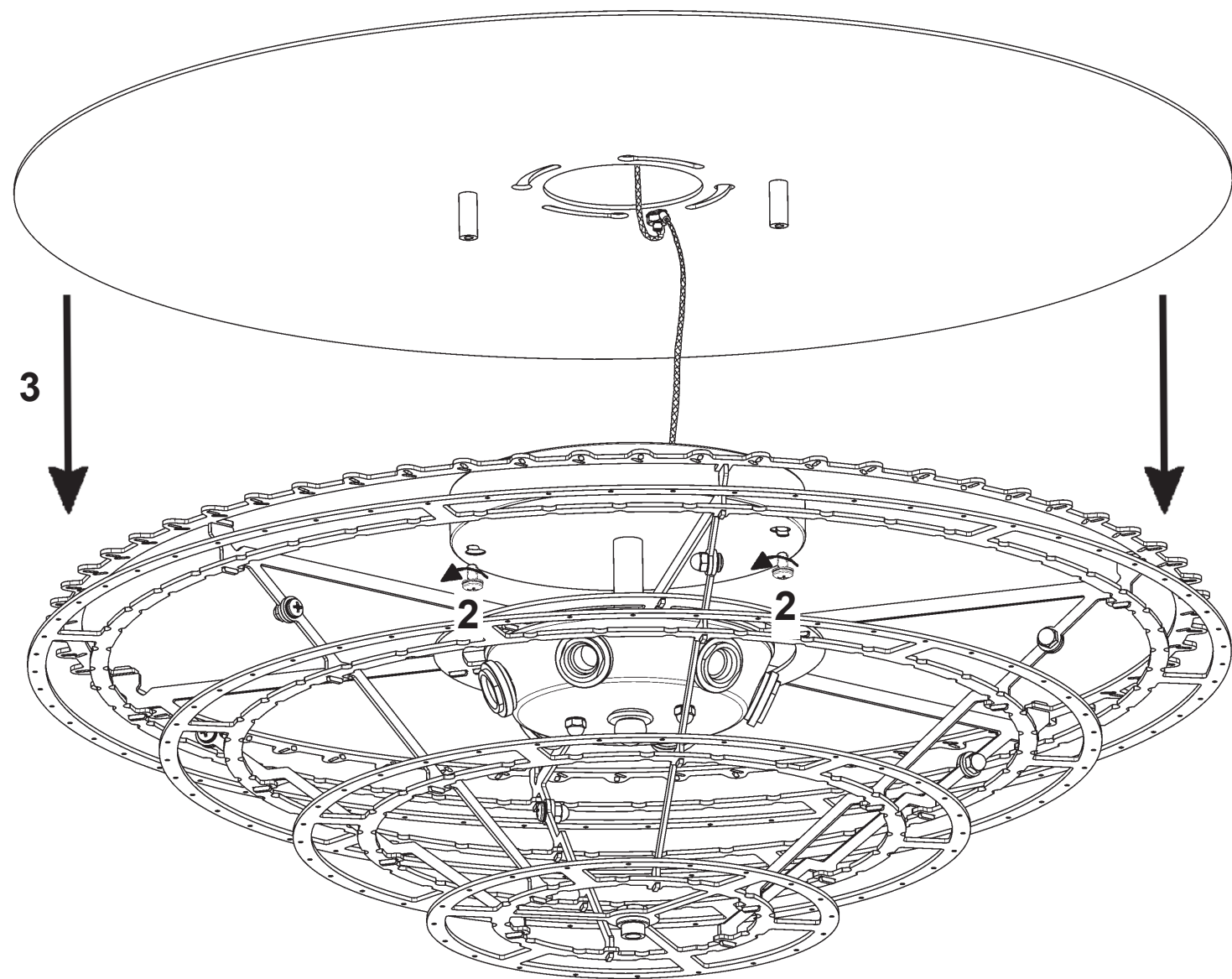

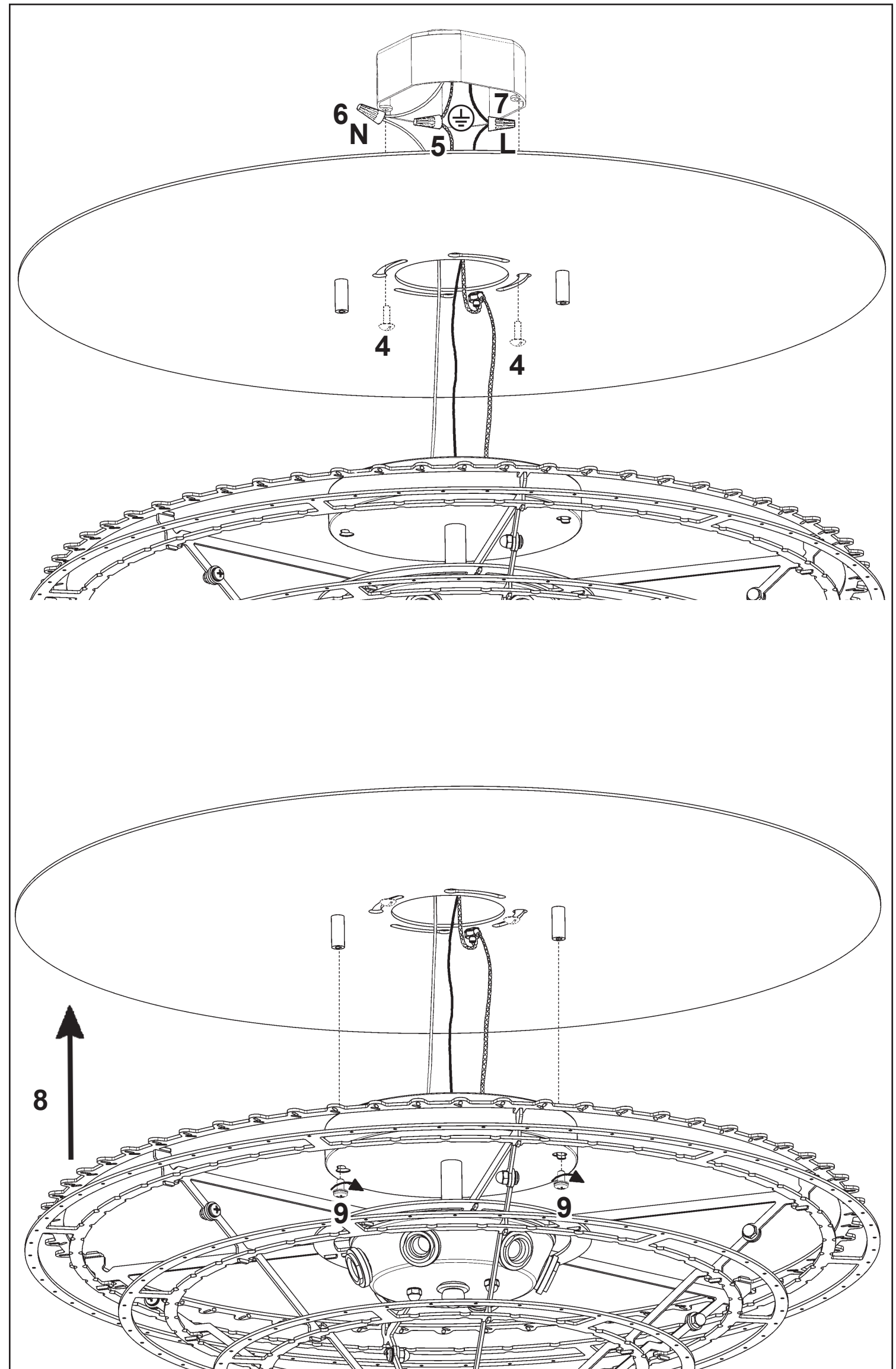

10

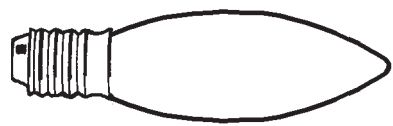

You will need 6 - B10
40 Watts Max

Install bulbs and be sure
to test fixture **BEFORE**
trimming.

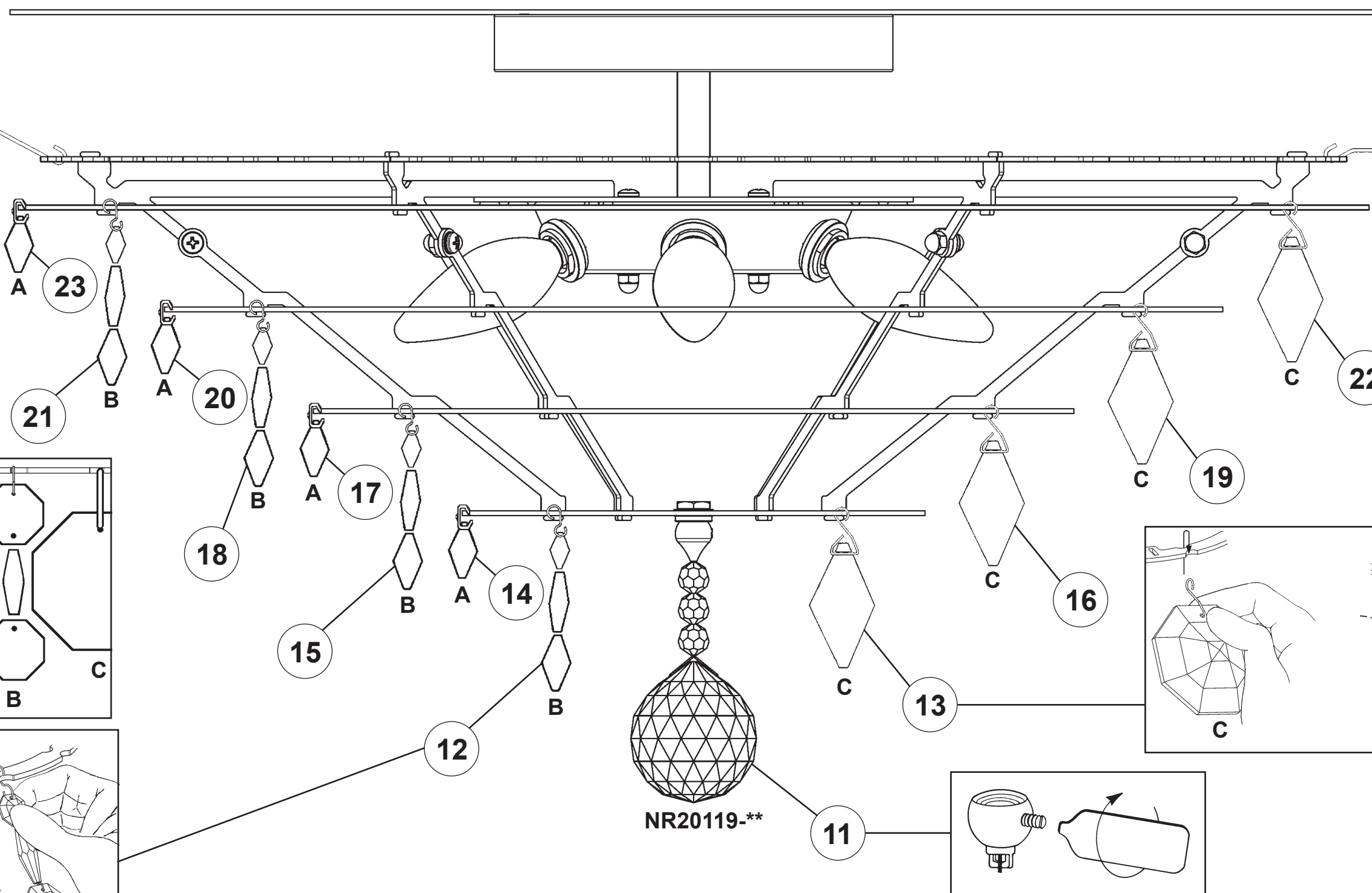
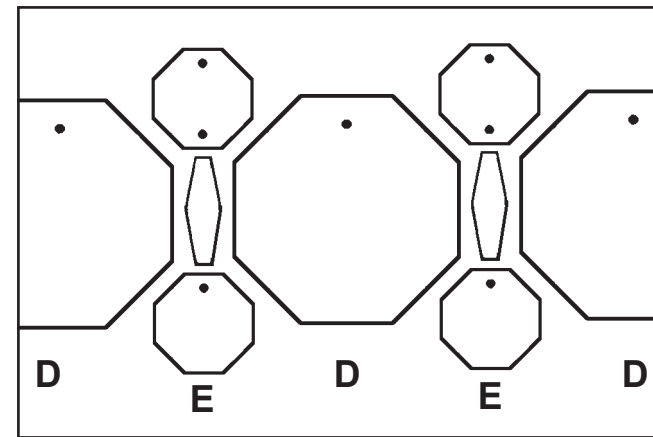
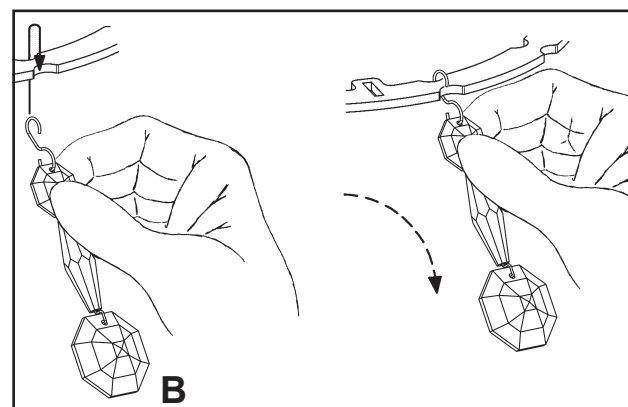
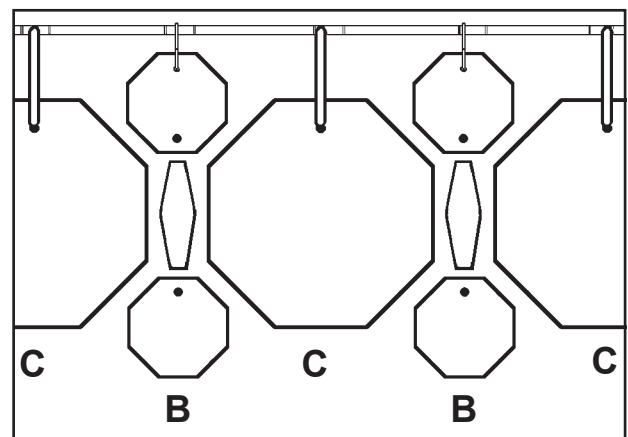
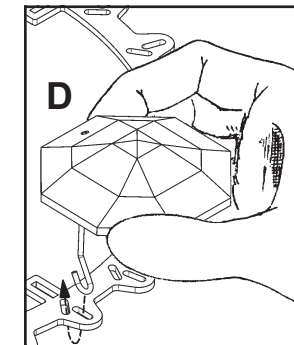
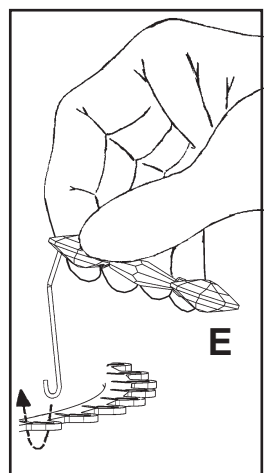

NR20119-**

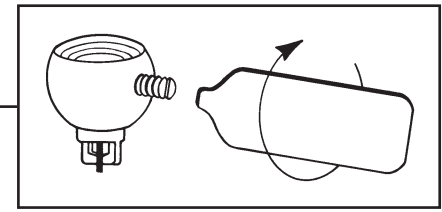

BARONET BN1424N- __ __ S

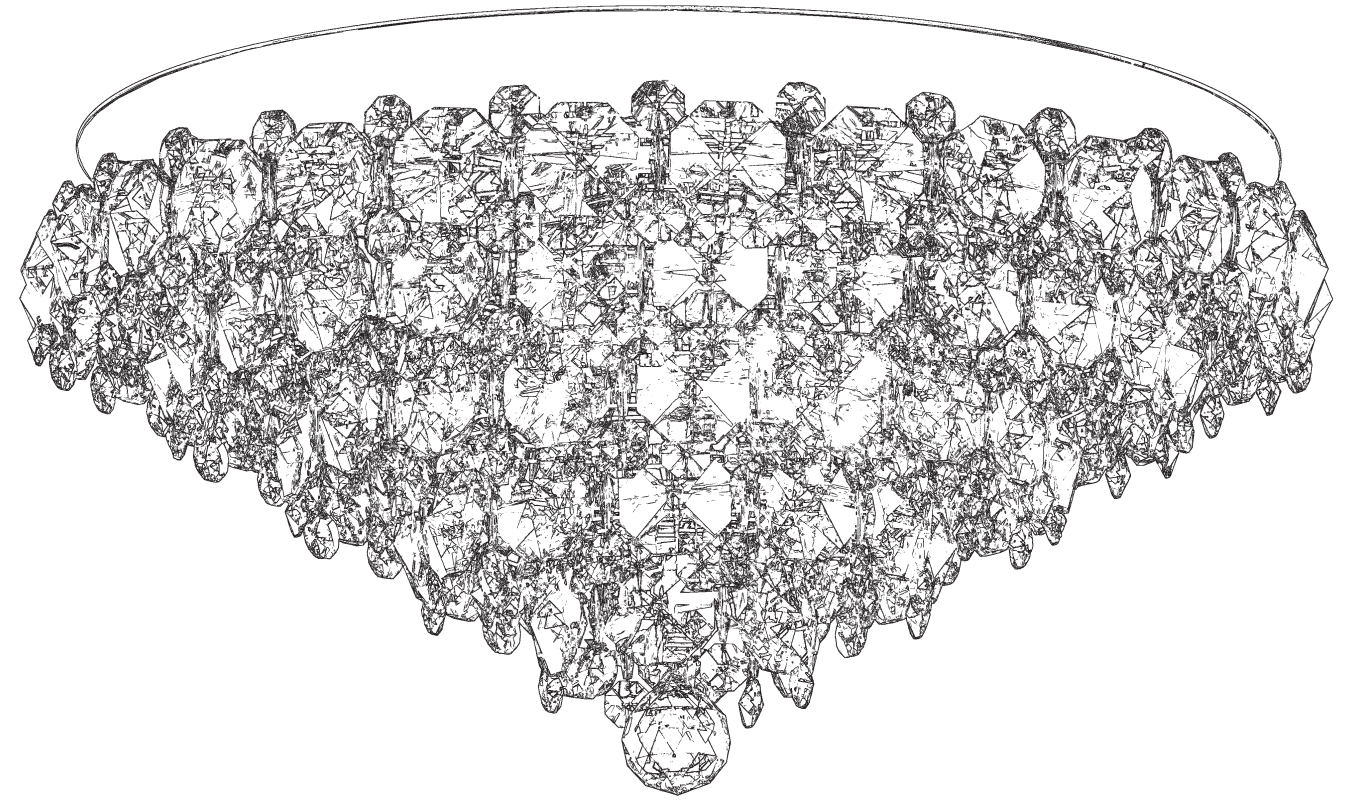











THIS DESIGN IS THE PROPRIETARY
TRADE DRESS/TRADEMARK OF
W SCHONBEK LLC.

6 Lights
Diameter: 24"
Height: 12"
Hanging Weight: 32lbs.

 **SCHONBEK** | 1870

 **SCHONBEK** | 1870

								
MAX 40 W	110-120 V							

WARNING:

1

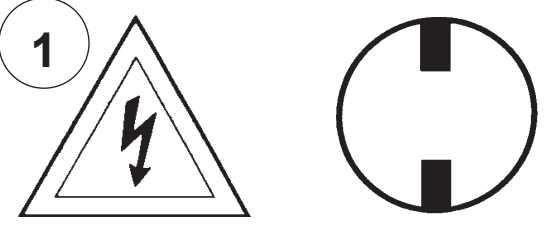

Electrical Danger **Turn Power Off**

All electrical components must be installed by a licensed electrician in accordance with the National Electric Code and the appropriate local electrical codes.

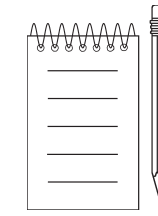
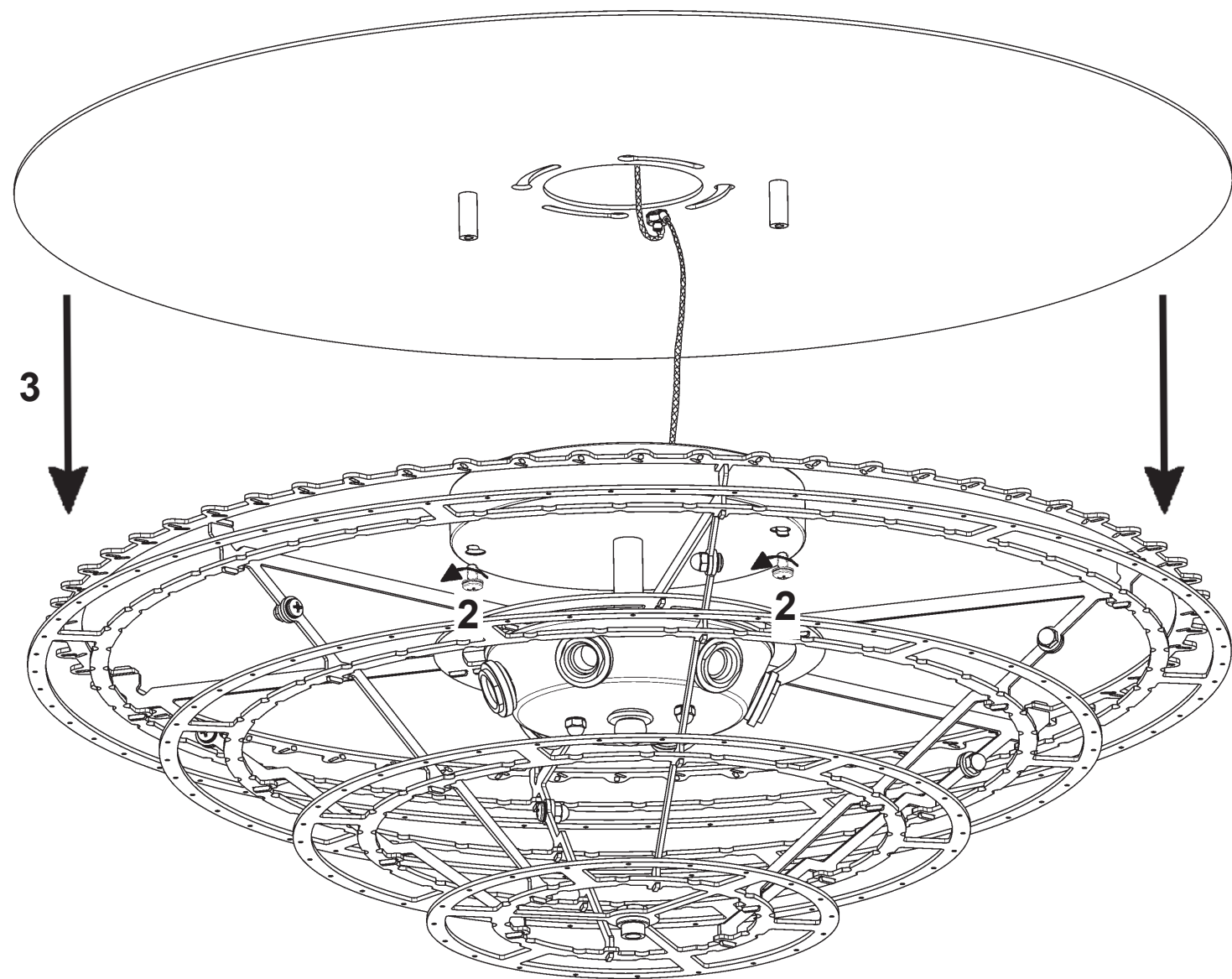

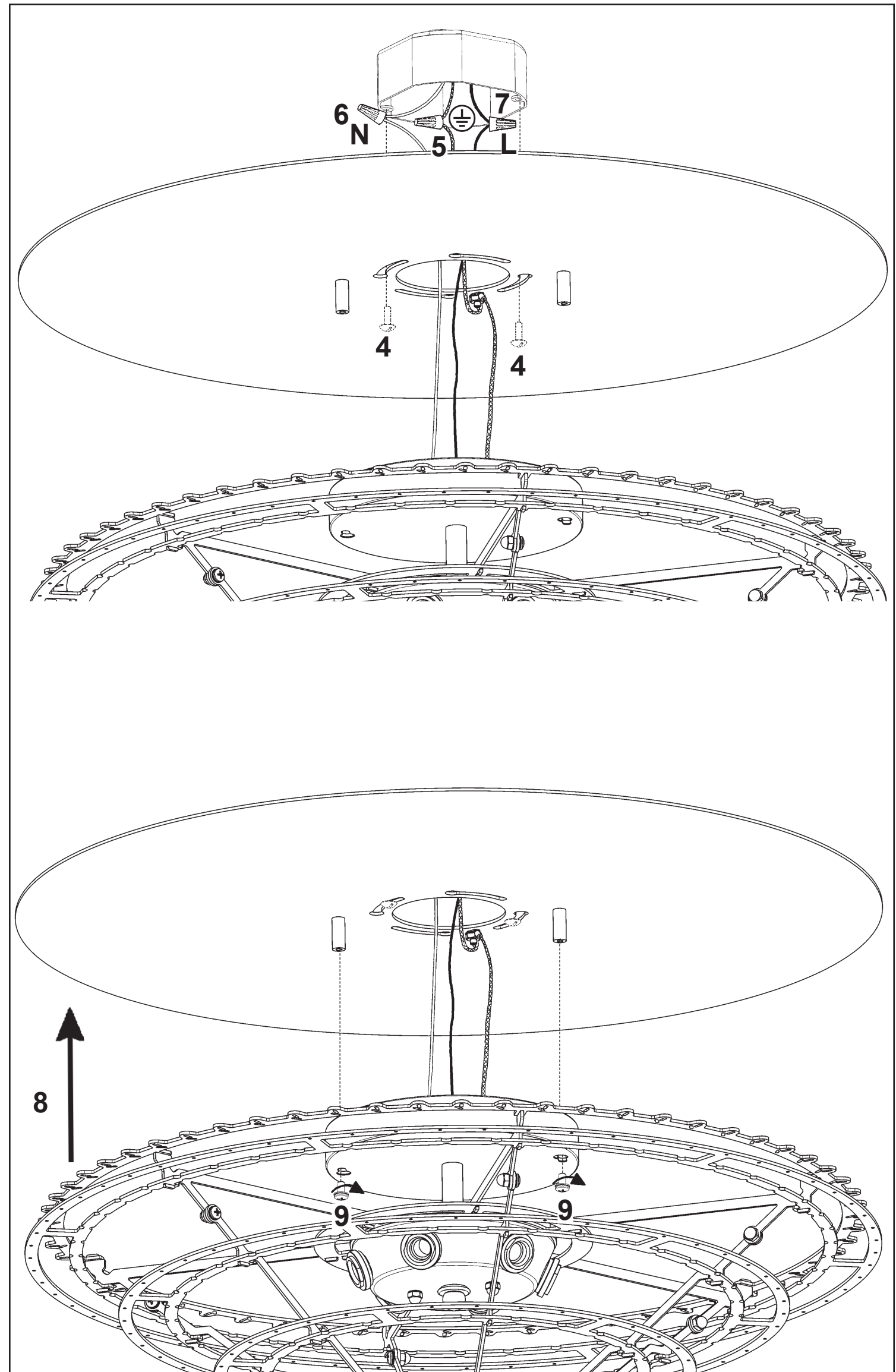

10

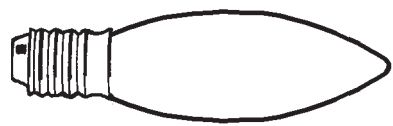

You will need 6 - B10
40 Watts Max

Install bulbs and be sure
to test fixture **BEFORE**
trimming.

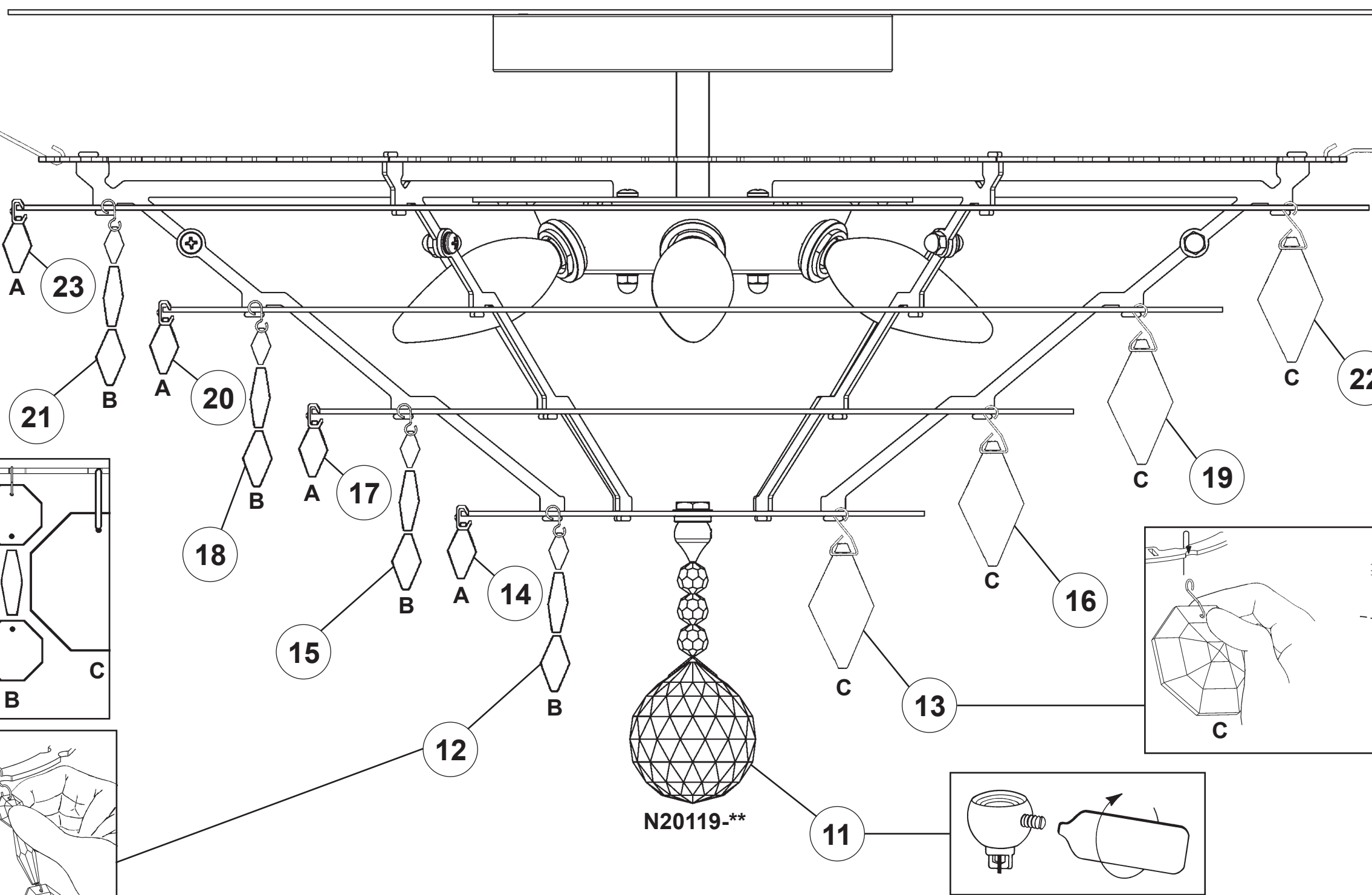
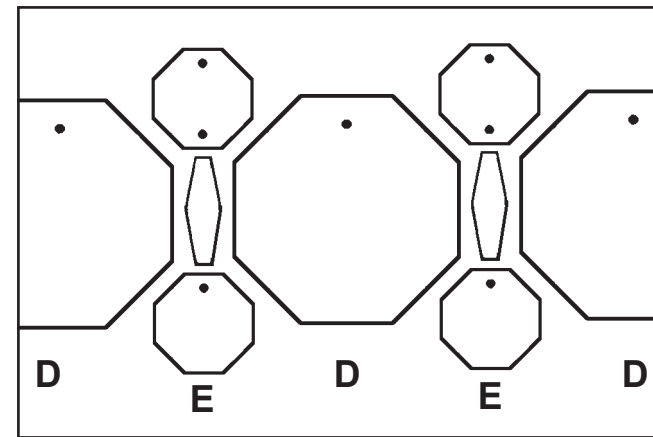
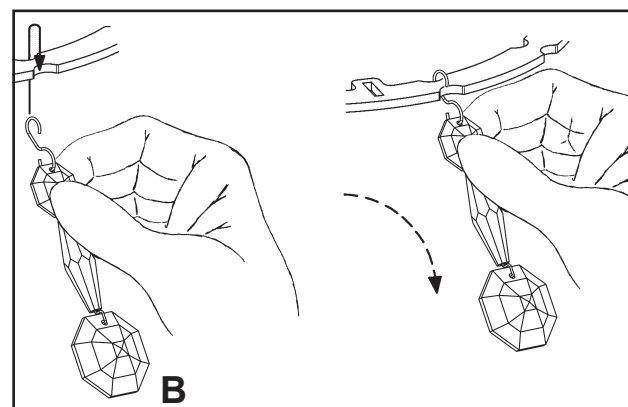
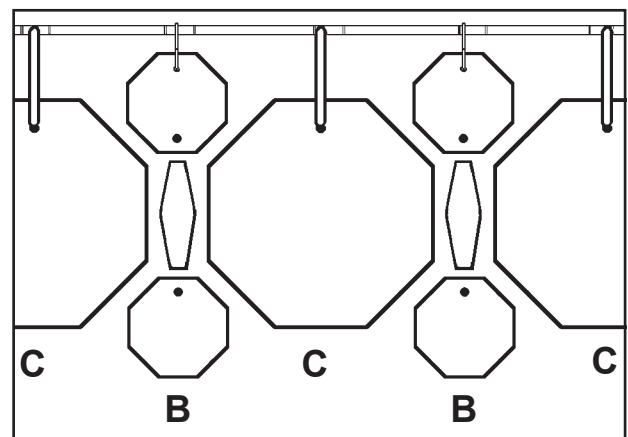
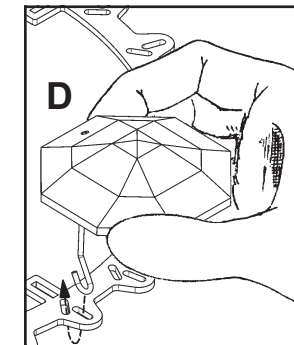
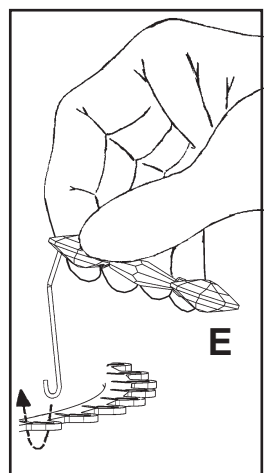

N20119-**

