

 **SCHONBEK** | 1870

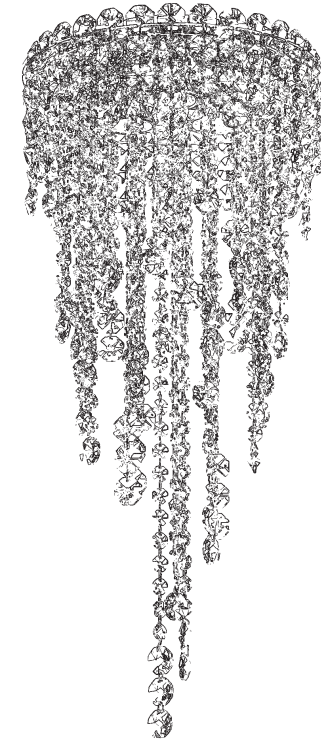







CHANTANT
CH0802N- __ _ O



THIS DESIGN IS THE PROPRIETARY
TRADE DRESS/TRADEMARK OF
W SCHONBEK LLC.



3 Lights
Diameter: 10-1/2"
Height: 25"
Hanging Weight: 9-1/2lbs.

 **SCHONBEK** | 1870

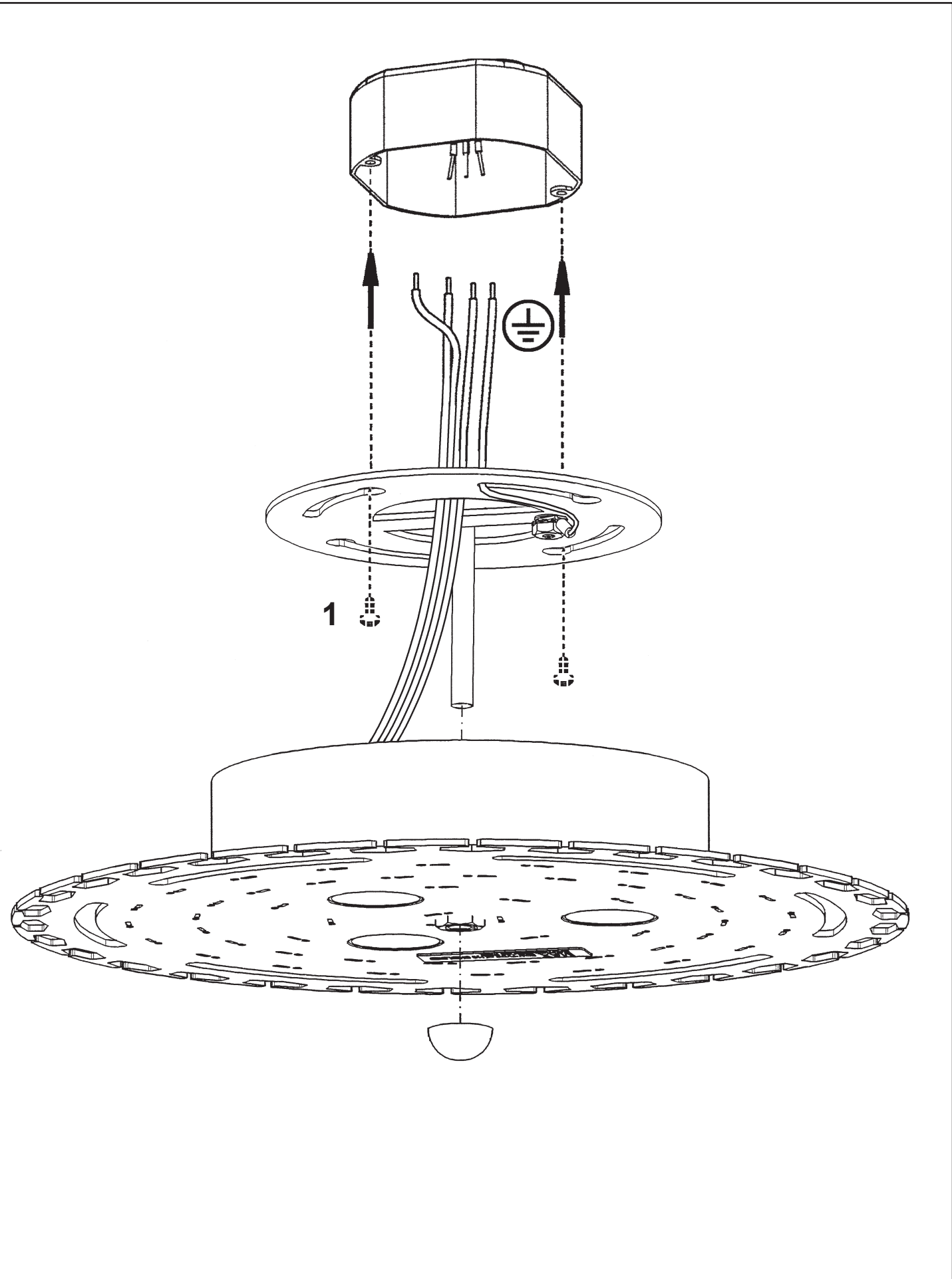
			S					
MAX 35 W	110-120 V							

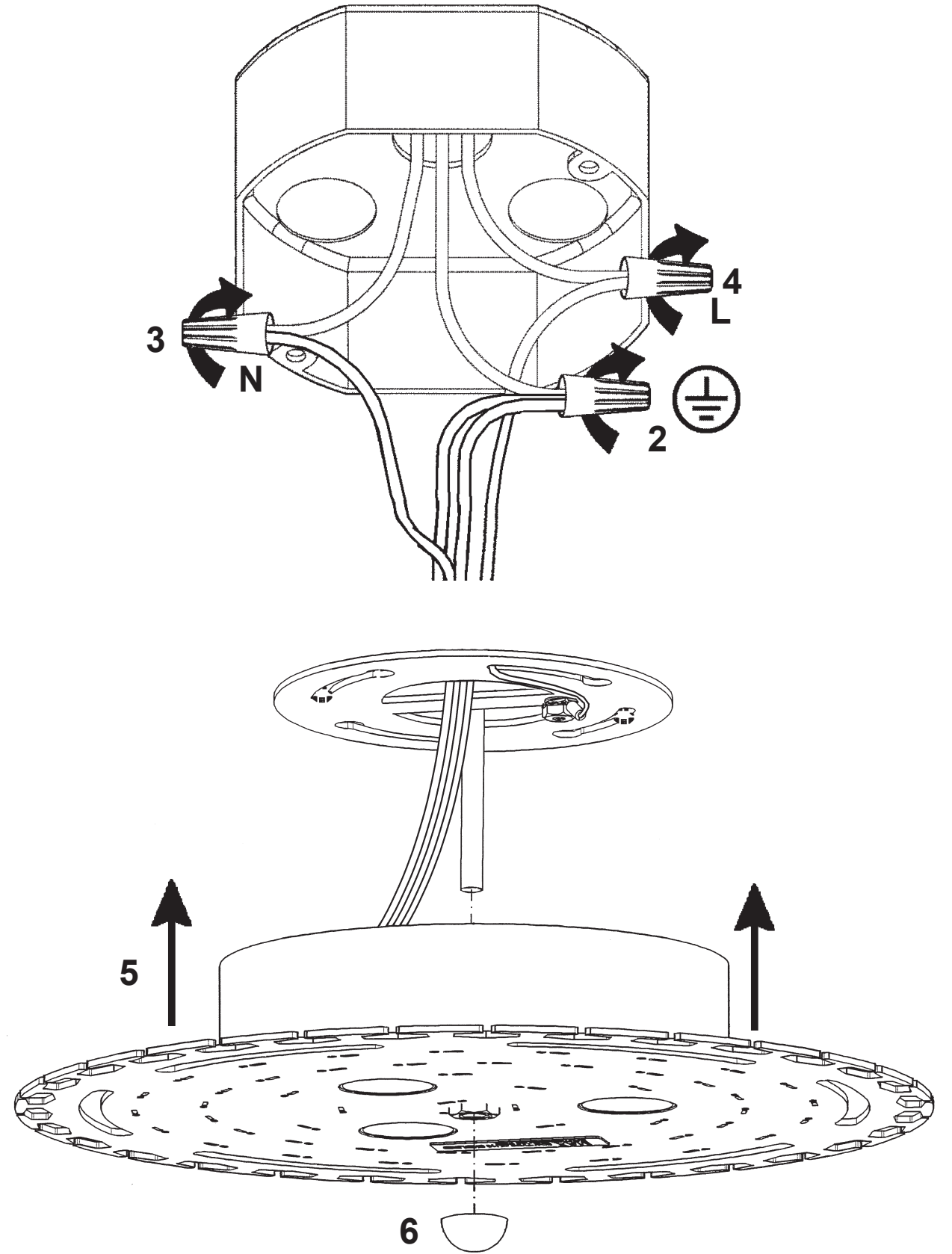
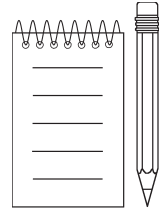

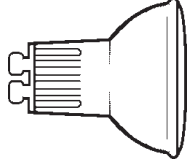

3 X  : GU10 35W MAX 

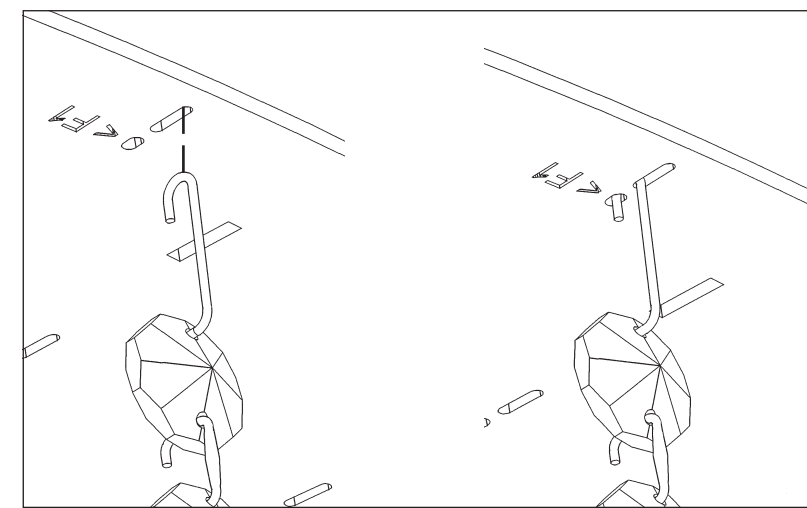
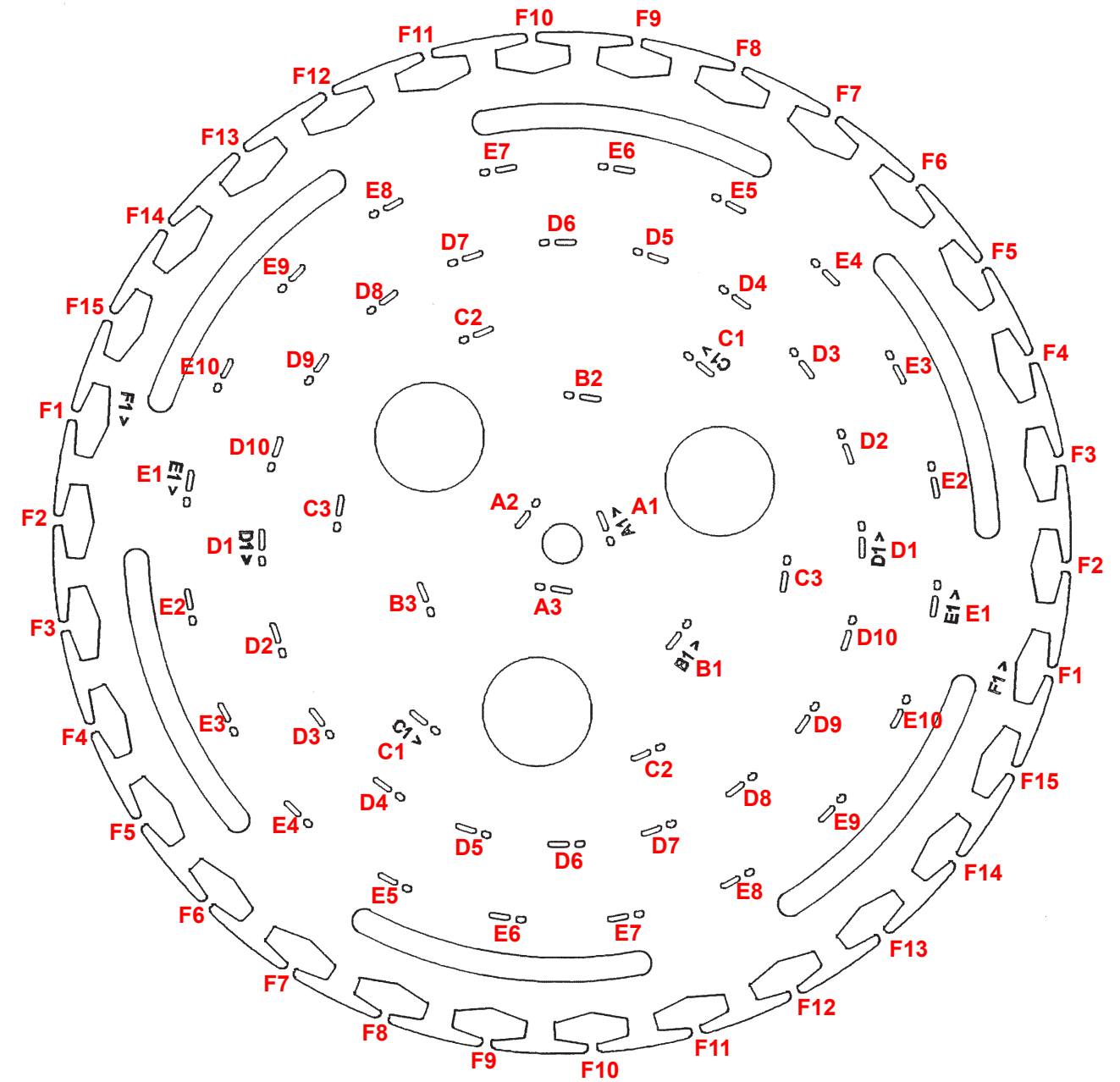
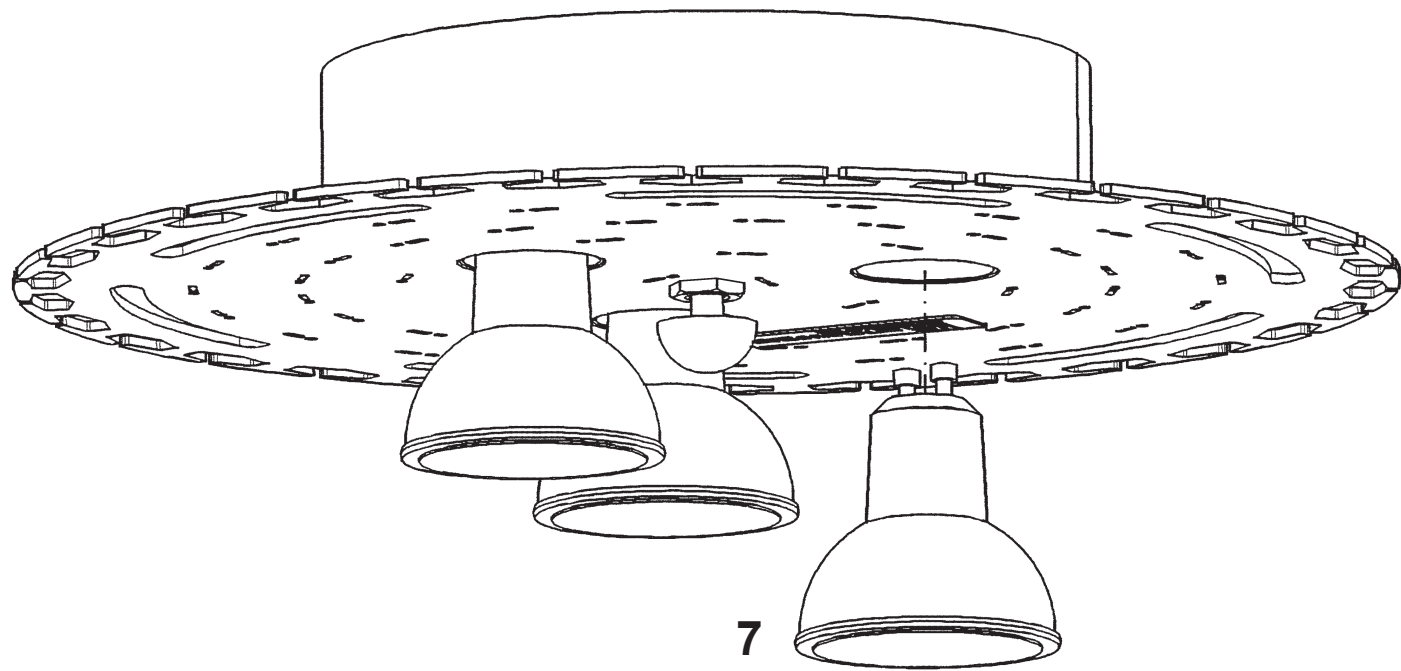

- 8 A1 - A3
- 9 B1 - B3
- 10 C1 - C3
- 11 D1 - D10
- 12 E1 - E10
- 13 F1 - F15

After hanging all trim, remove labels from crystals. If residue remains, wipe off crystal with a soft, dry cloth.



CHANTANT CH0802N- __ __ R

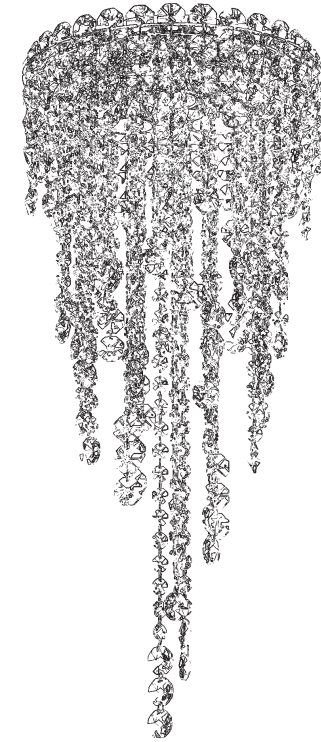

THIS DESIGN IS THE PROPRIETARY
TRADE DRESS/TRADEMARK OF
W SCHONBEK LLC.



3 Lights
Diameter: 10-1/2"
Height: 25"
Hanging Weight: 9-1/2lbs.

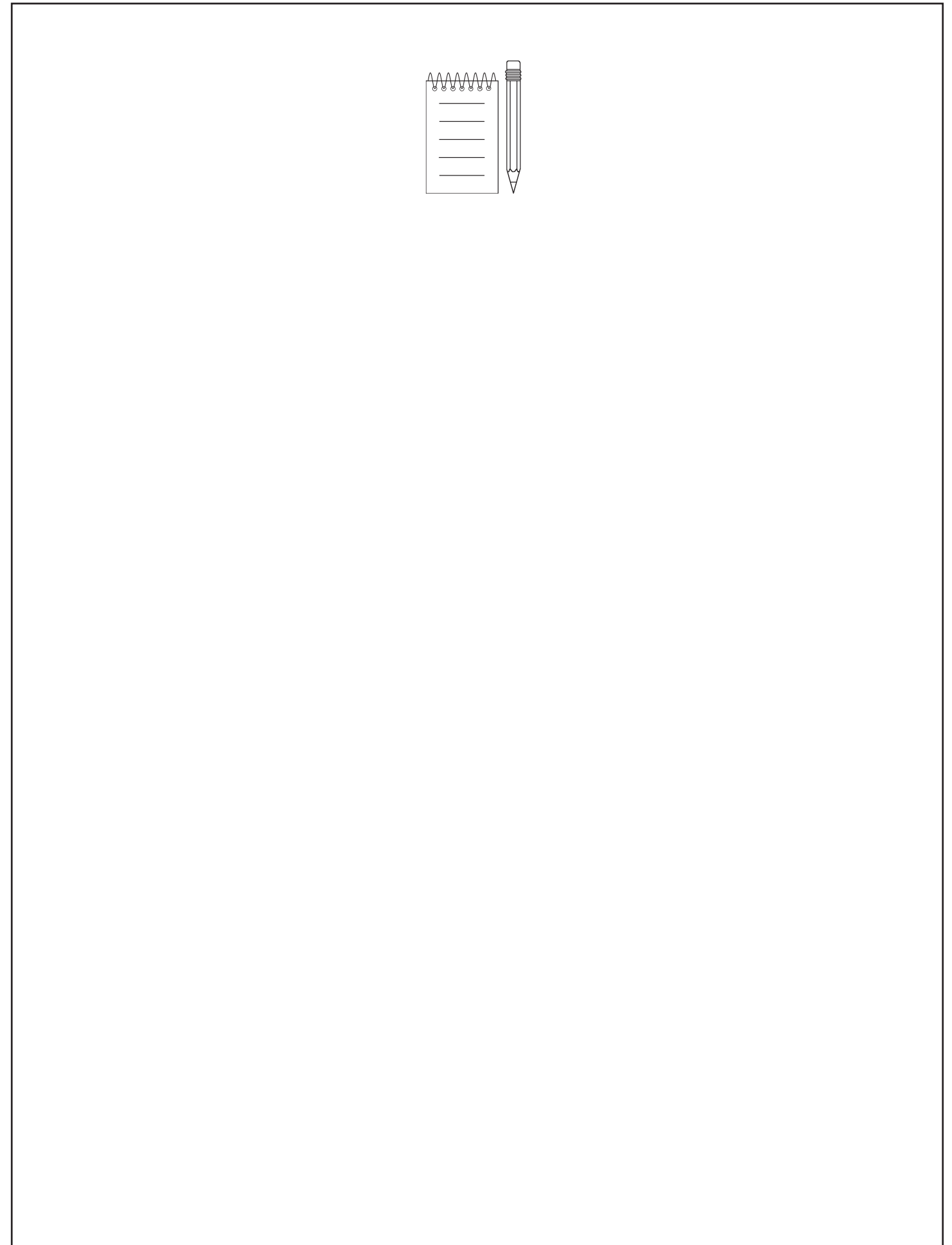
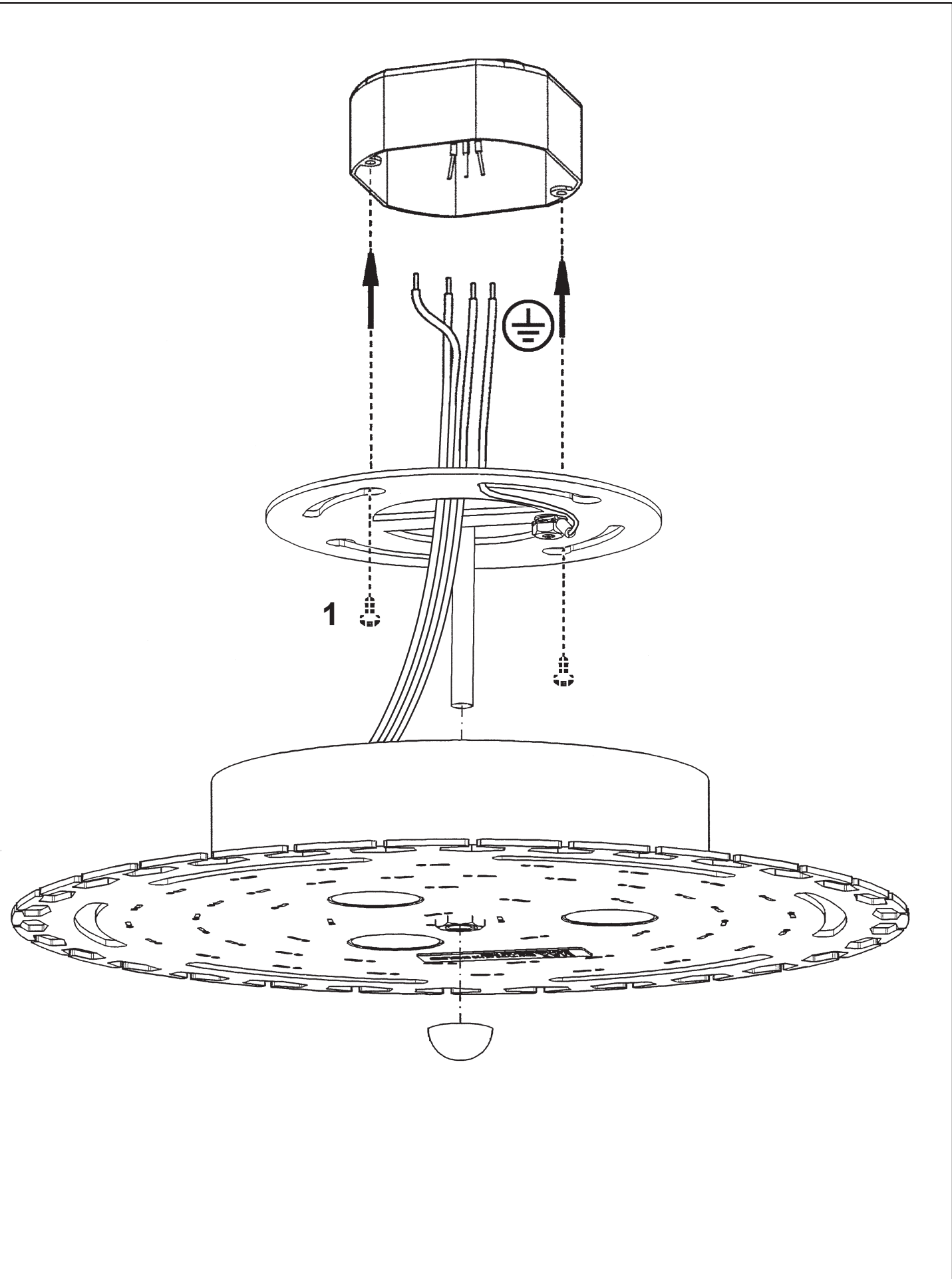

MAX 35 W	110-120 V						

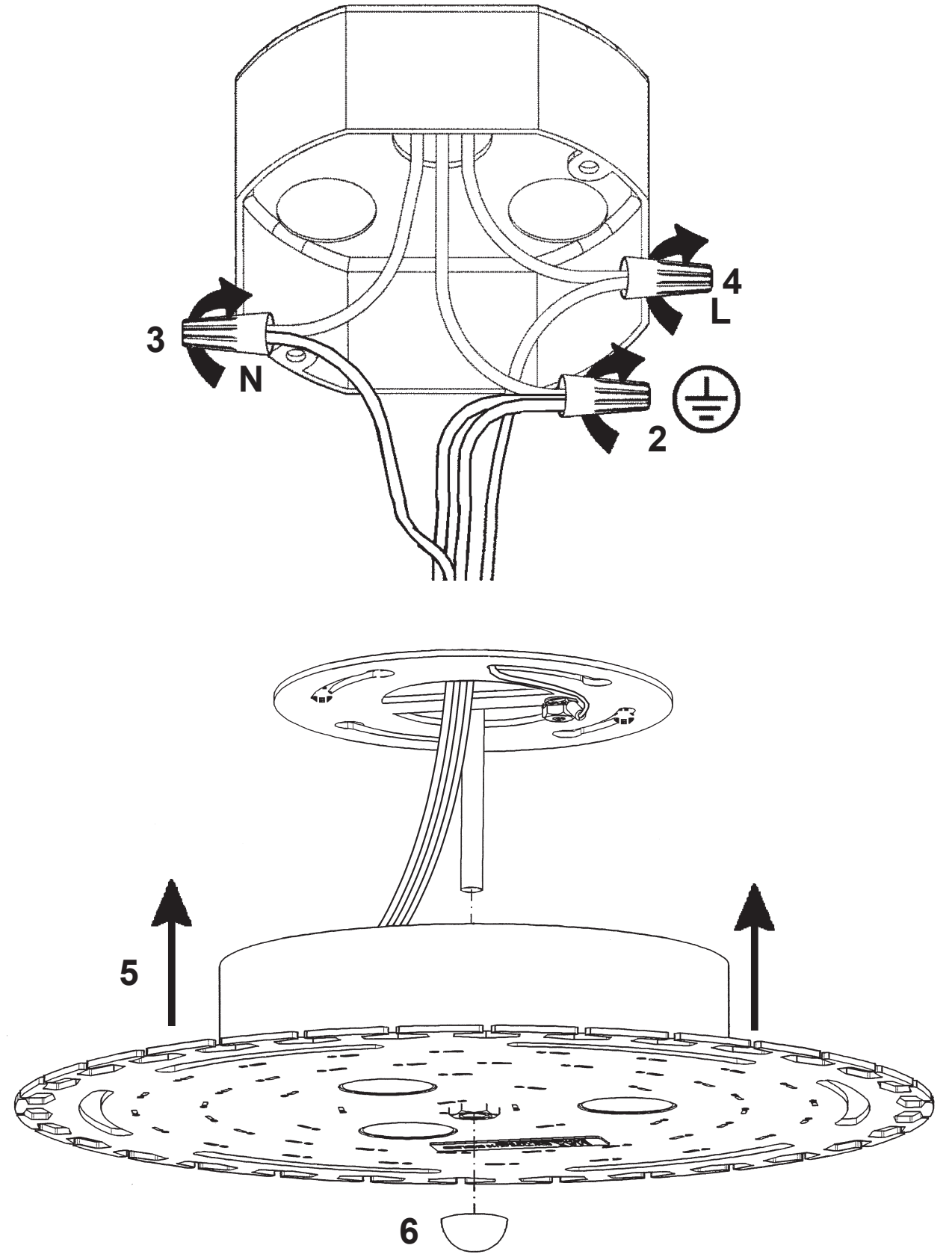
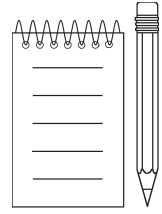

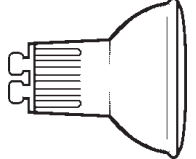

3 X  : GU10 35W MAX 

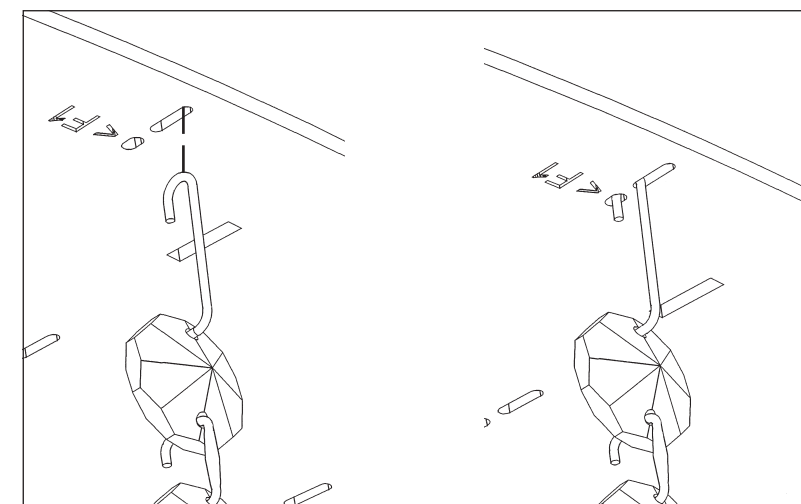
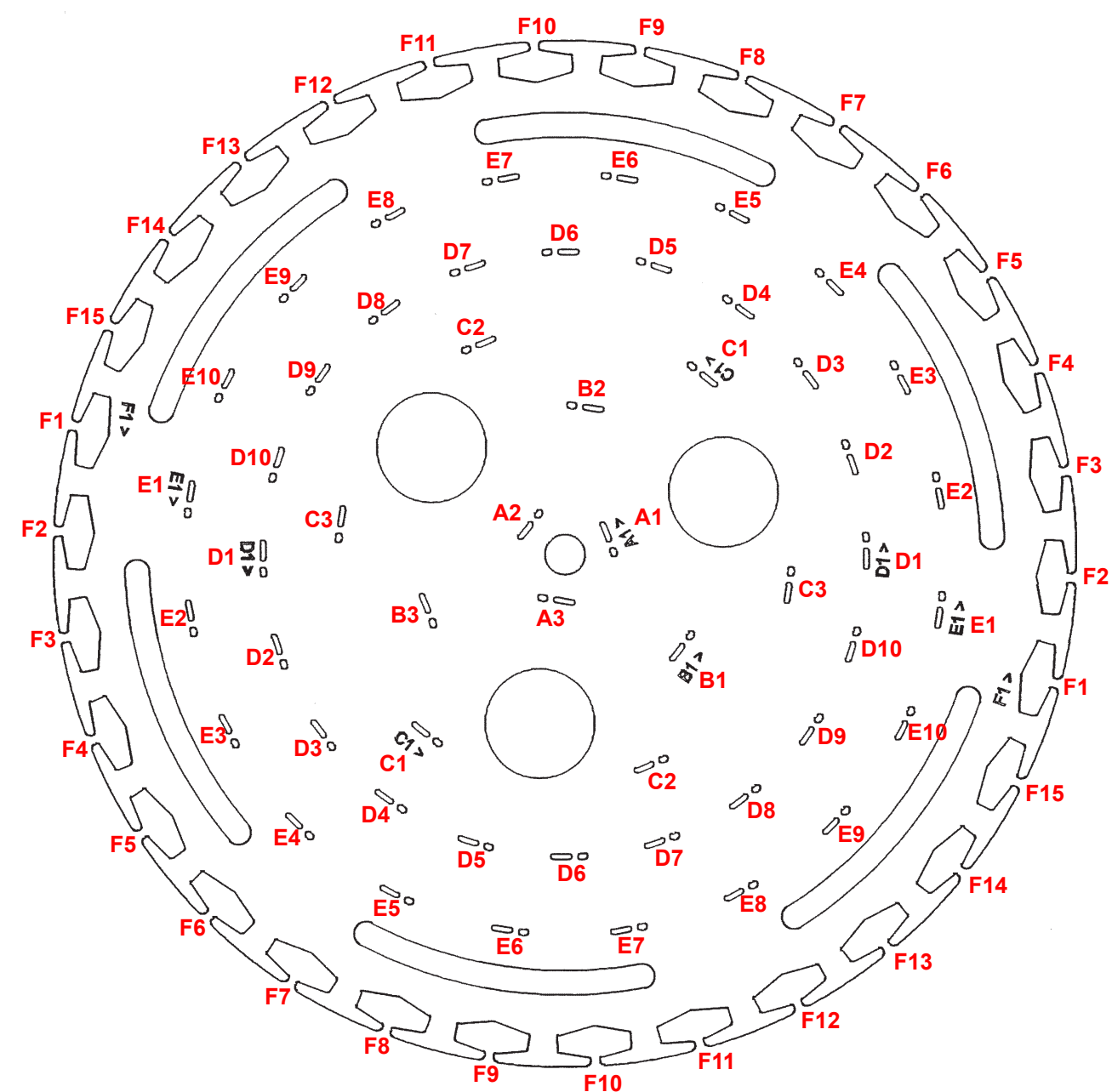
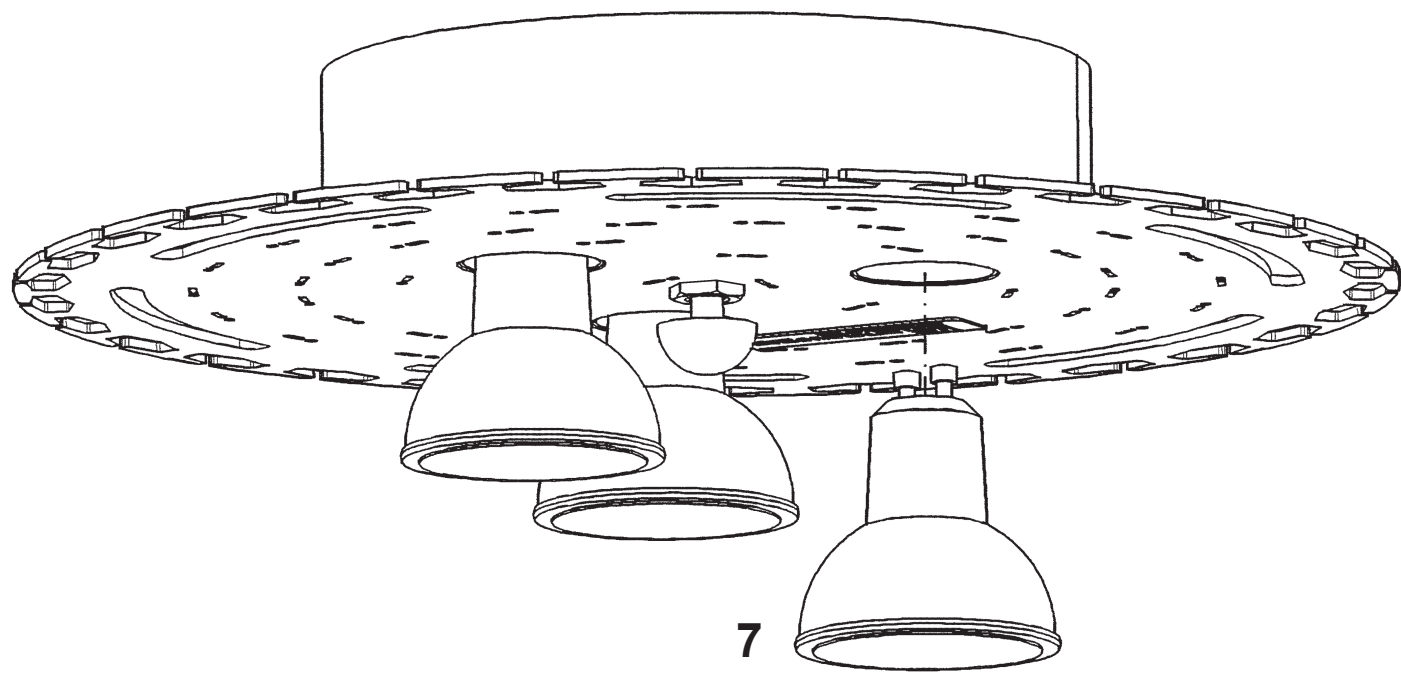

- 8 A1 - A3
- 9 B1 - B3
- 10 C1 - C3
- 11 D1 - D10
- 12 E1 - E10
- 13 F1 - F15

After hanging all trim, remove labels from crystals. If residue remains, wipe off crystal with a soft, dry cloth.