

 **SCHONBEK** | 1870

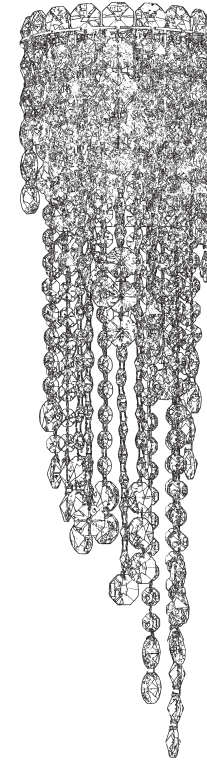







**CHANTANT**  
**CH0833N- \_\_ \_\_ O**



**T**HIS DESIGN IS THE PROPRIETARY  
TRADE DRESS/TRADEMARK OF  
W SCHONBEK LLC.

2 Lights  
Length: 6-1/2"  
Height: 23"  
Extension: 6"  
Hanging Weight: 6lbs.

 **SCHONBEK** | 1870

|   |   |   |          |   |   |   |   |   |
|---|---|---|----------|---|---|---|---|---|
|  |  |  | <b>S</b> |  |  |  |  |  |
| MAX <b>40</b> W   | 110-120 V   |  |          |   |   |   |   |   |

2 X  : G9 40W MAX 

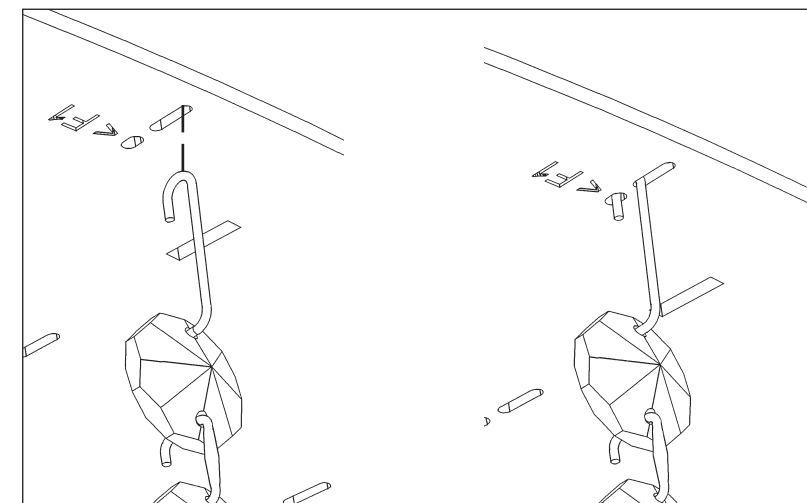
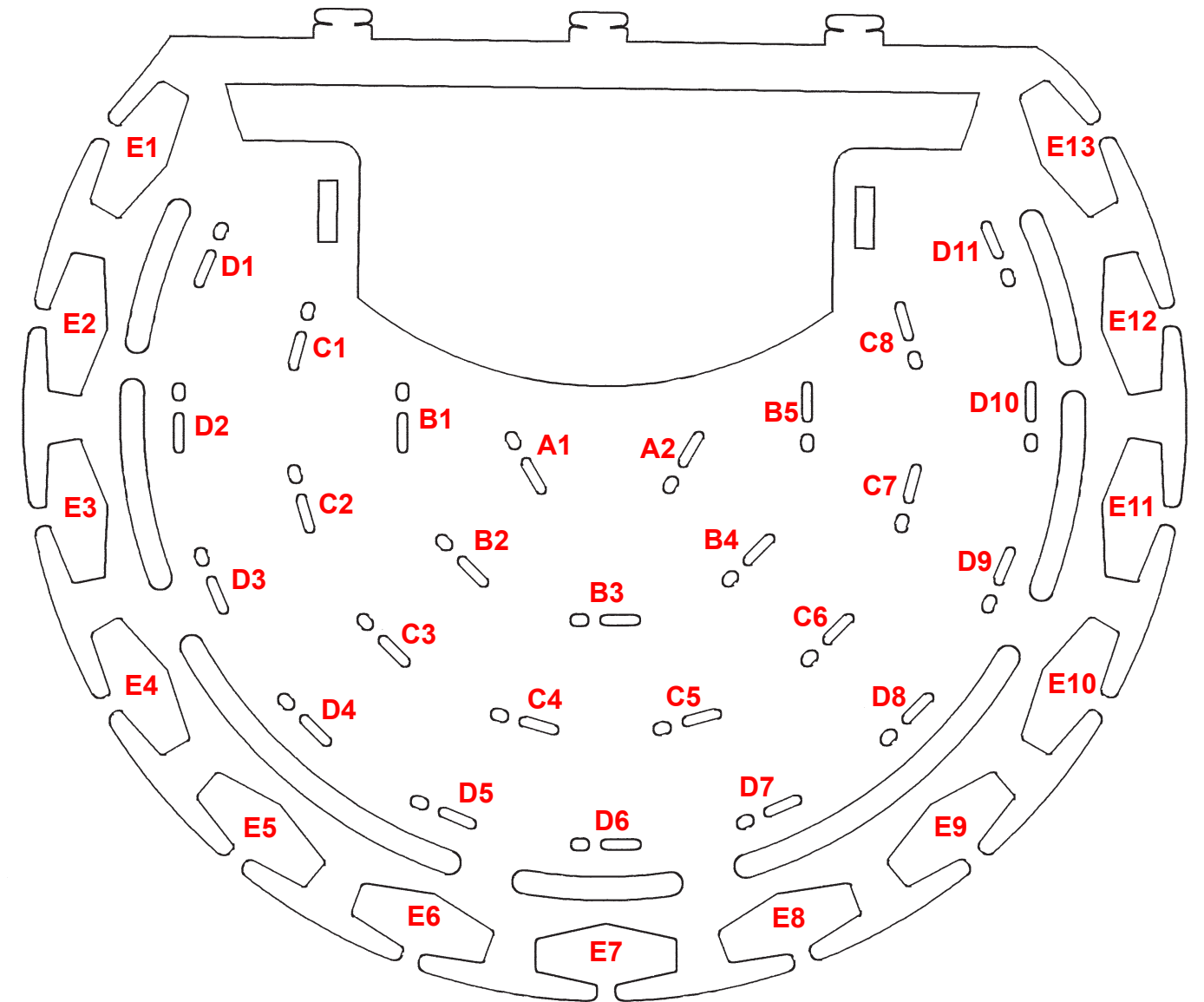
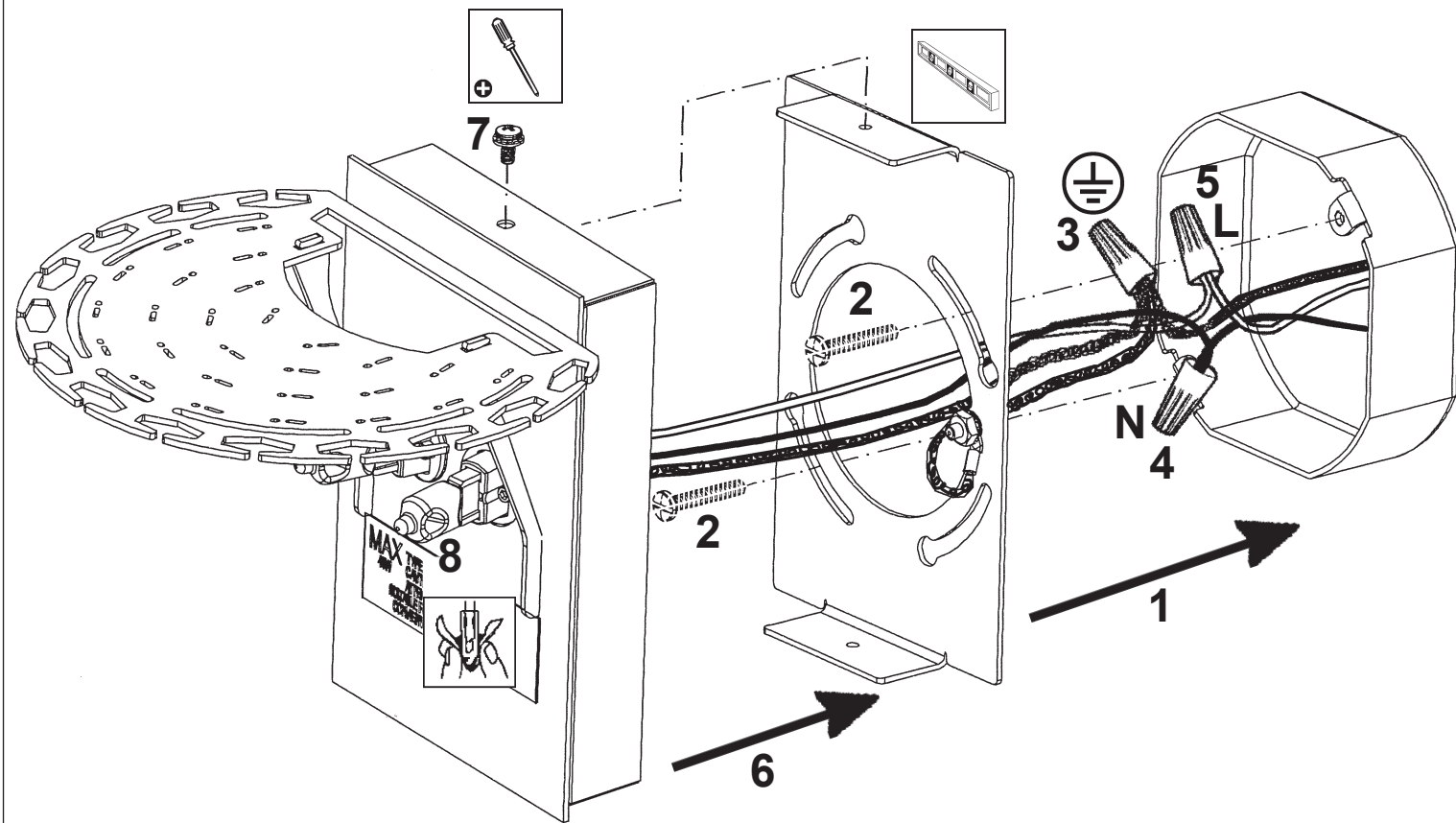

- 9 A1 - A2
- 10 B1 - B5
- 11 C1 - C8
- 12 D1 - D11
- 13 E1 - E13

After hanging all trim, remove labels from crystals. If residue remains, wipe off crystal with a soft, dry cloth.

 **SCHONBEK** | 1870



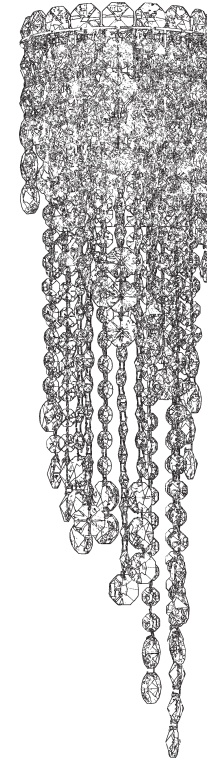







**CHANTANT**  
**CH0833N- \_\_ \_\_ R**



**T**HIS DESIGN IS THE PROPRIETARY  
TRADE DRESS/TRADEMARK OF  
W SCHONBEK LLC.

2 Lights  
Length: 6-1/2"  
Height: 23"  
Extension: 6"  
Hanging Weight: 6lbs.

 **SCHONBEK** | 1870

|   |   |   |          |   |   |   |   |   |   |
|---|---|---|----------|---|---|---|---|---|---|
|  |  |  | <b>S</b> |  |  |  |  |  |  |
| MAX <b>40</b> W   | 110-120 V   |  |          |   |   |   |   |   |   |

2 X  : G9 40W MAX 

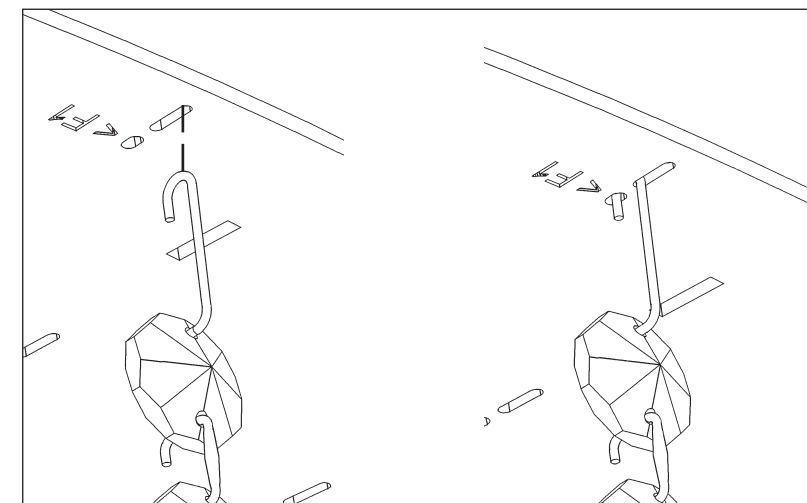
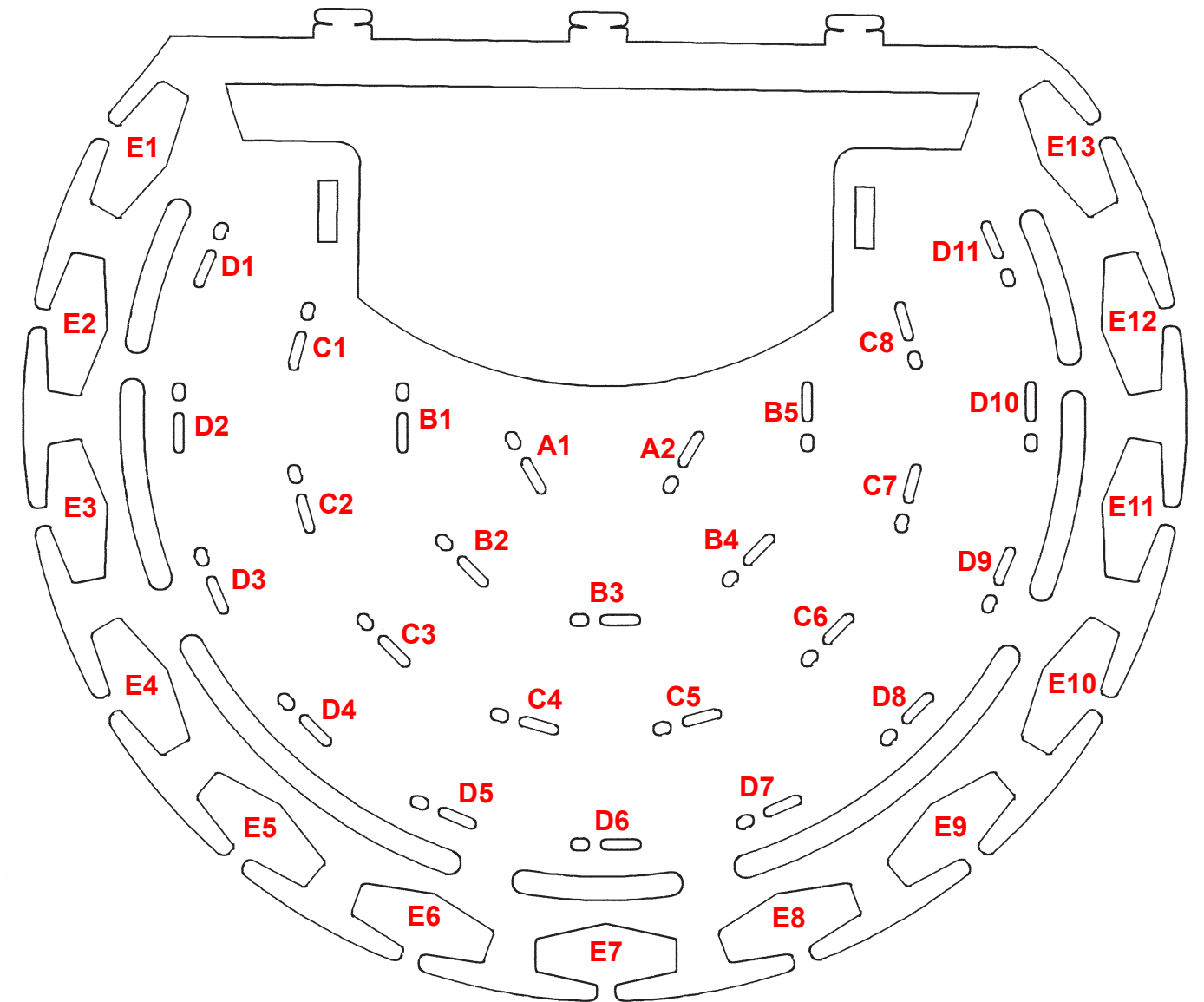
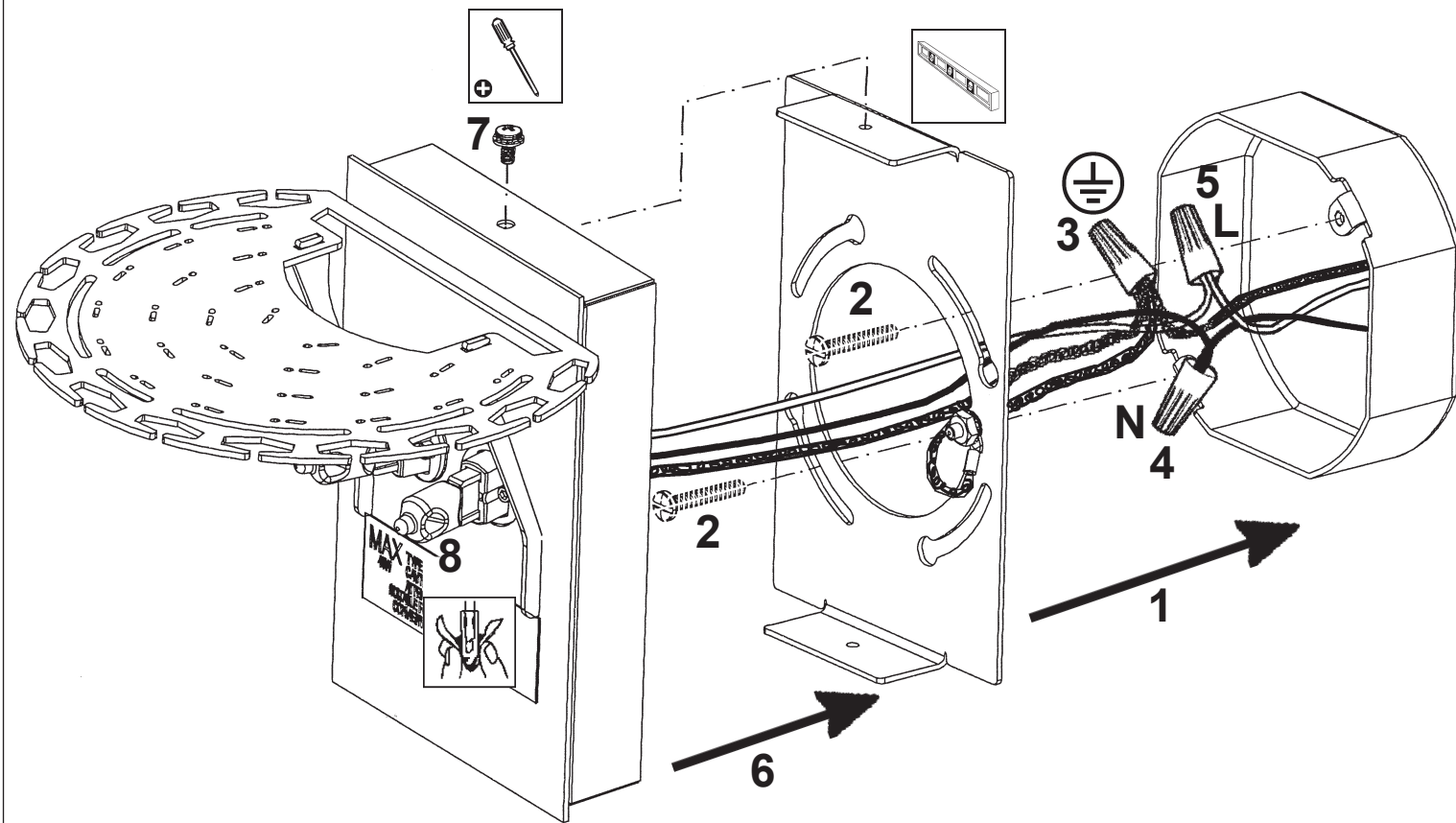

- |    |          |
|----|----------|
| 9  | A1 - A2  |
| 10 | B1 - B5  |
| 11 | C1 - C8  |
| 12 | D1 - D11 |
| 13 | E1 - E13 |

After hanging all trim, remove labels from crystals. If residue remains, wipe off crystal with a soft, dry cloth.