

 **SCHONBEK** | 1870











**CHANTANT**  
**CH2401N- \_\_ \_ O**



**T**HIS DESIGN IS THE PROPRIETARY  
TRADE DRESS/TRADEMARK OF  
W SCHONBEK LLC.

6 Lights  
Diameter: 24"  
Height: 20-1/2"  
Hanging Weight: 14lbs.

 **SCHONBEK** | 1870

								
MAX <b>35</b> W	110-120 V							

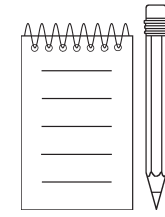
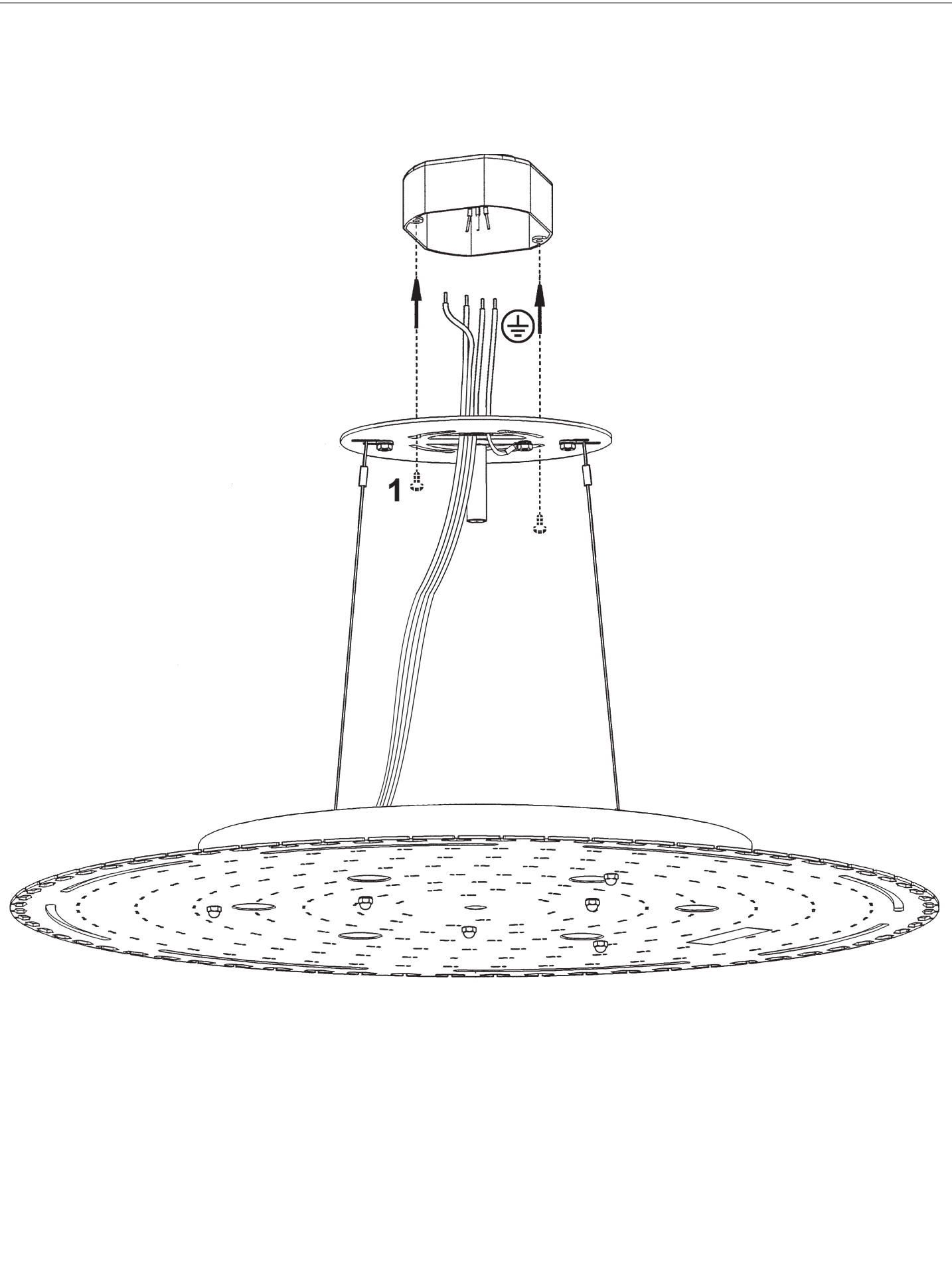

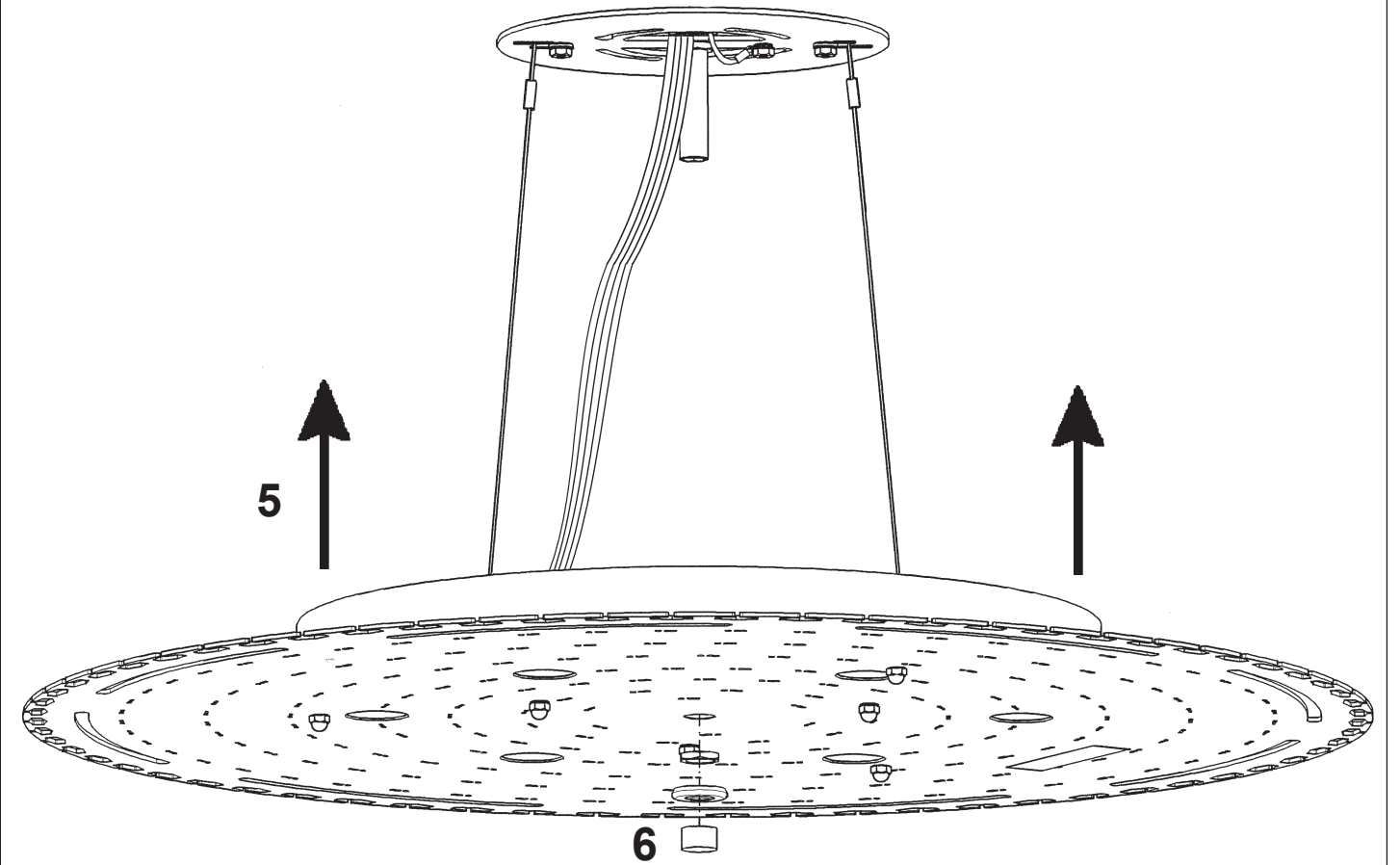
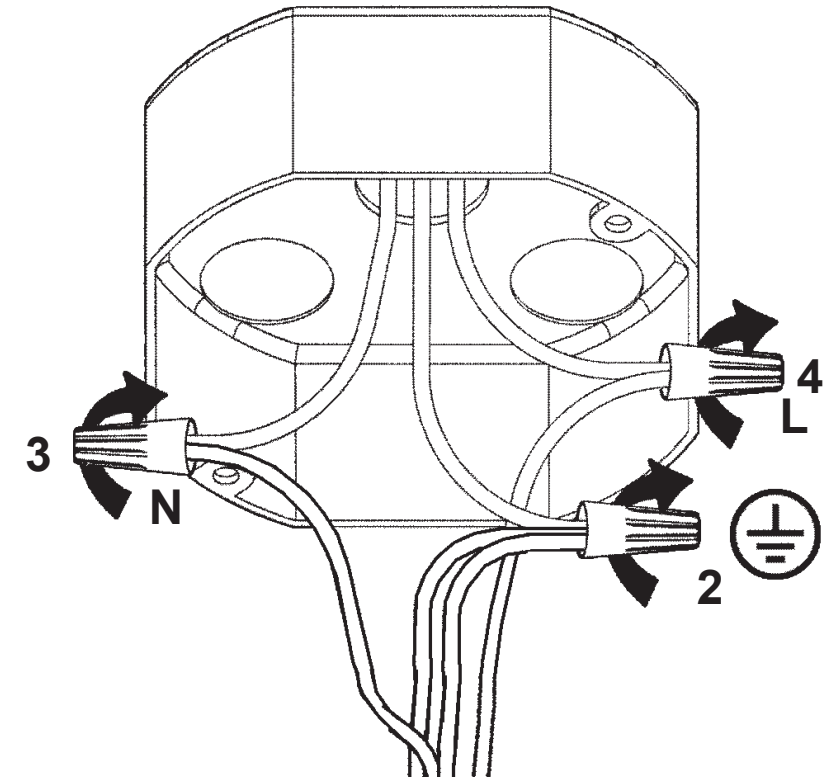
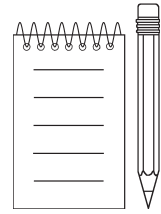

6 X  : GU10 35W MAX 

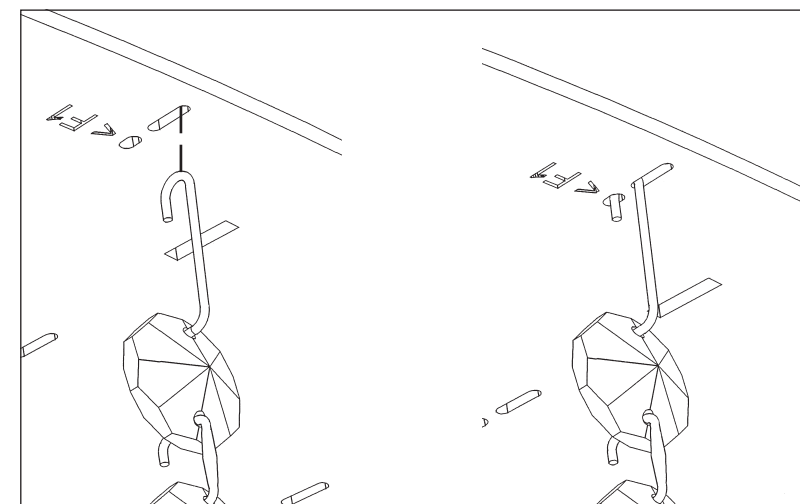
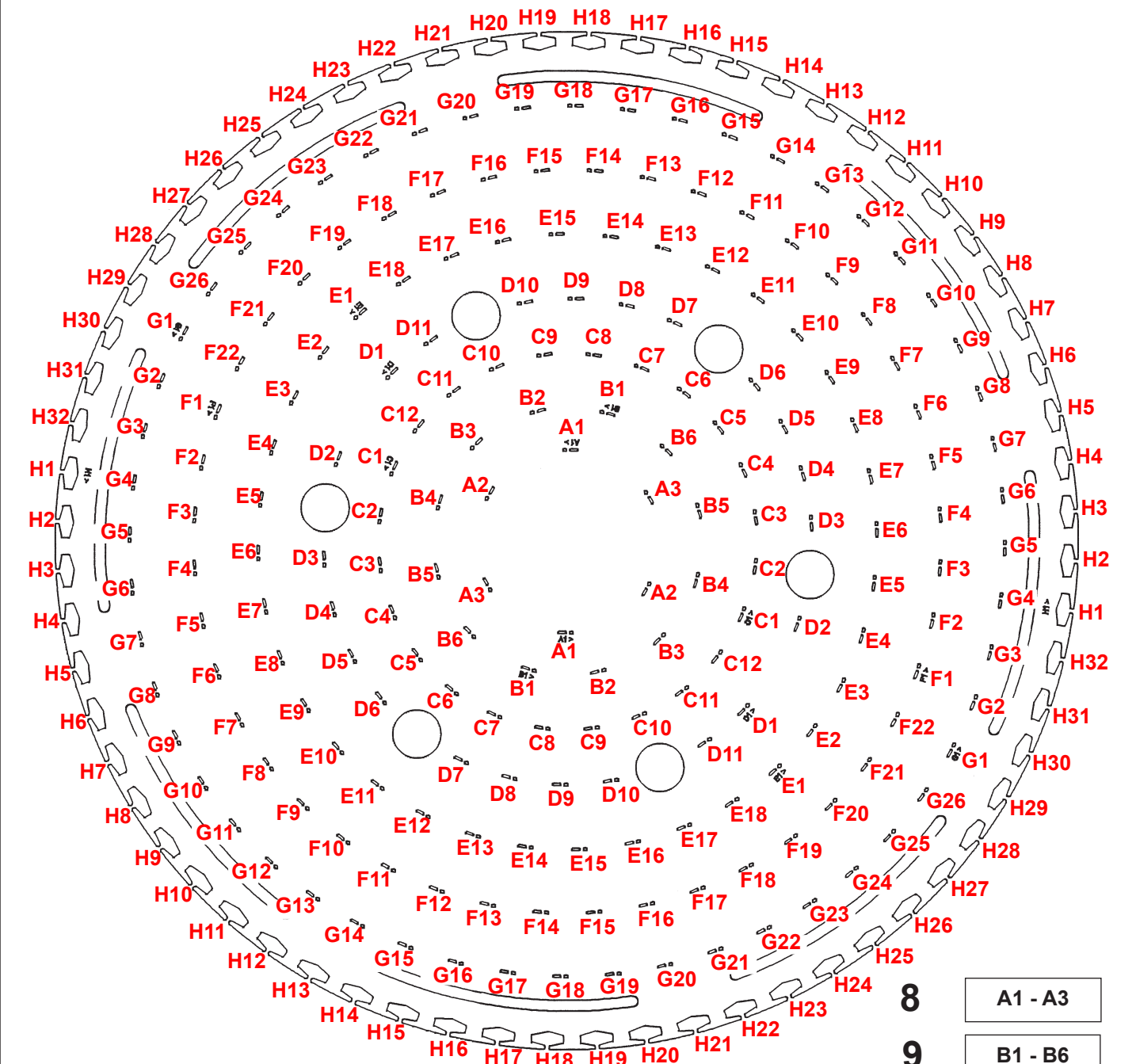
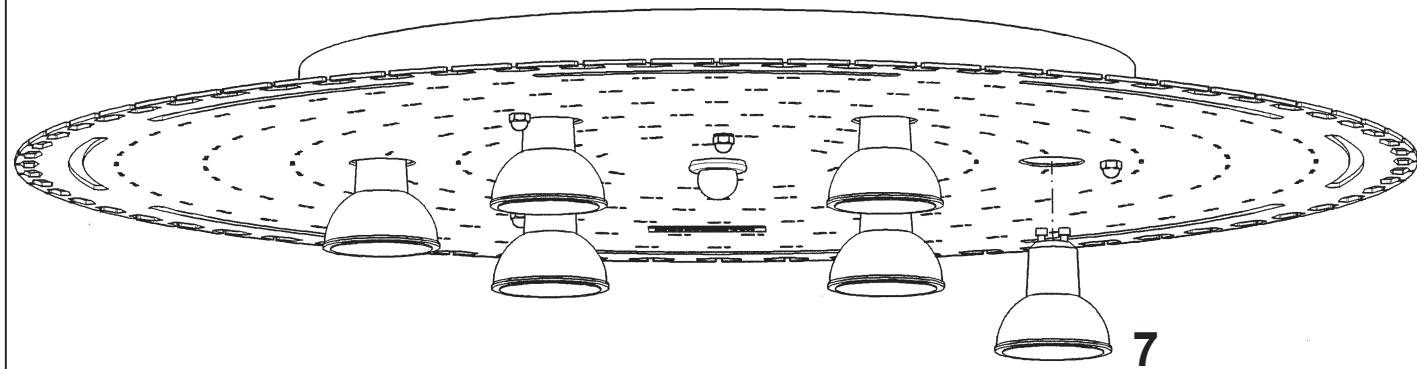

- 8** A1 - A3
- 9** B1 - B6
- 10** C1 - C12
- 11** D1 - D11
- 12** E1 - E18
- 13** F1 - F22
- 14** G1 - G26
- 15** H1 - H32

After hanging all trim, remove labels from crystals. If residue remains, wipe off crystal with a soft, dry cloth.

 **SCHONBEK** | 1870









# CHANTANT CH2401N- \_\_ \_R



**T**HIS DESIGN IS THE PROPRIETARY  
TRADE DRESS/TRADEMARK OF  
W SCHONBEK LLC.

6 Lights  
Diameter: 24"  
Height: 20-1/2"  
Hanging Weight: 14lbs.

 **SCHONBEK** | 1870

			<b>S</b>					
MAX <b>35</b> W	110-120 V							

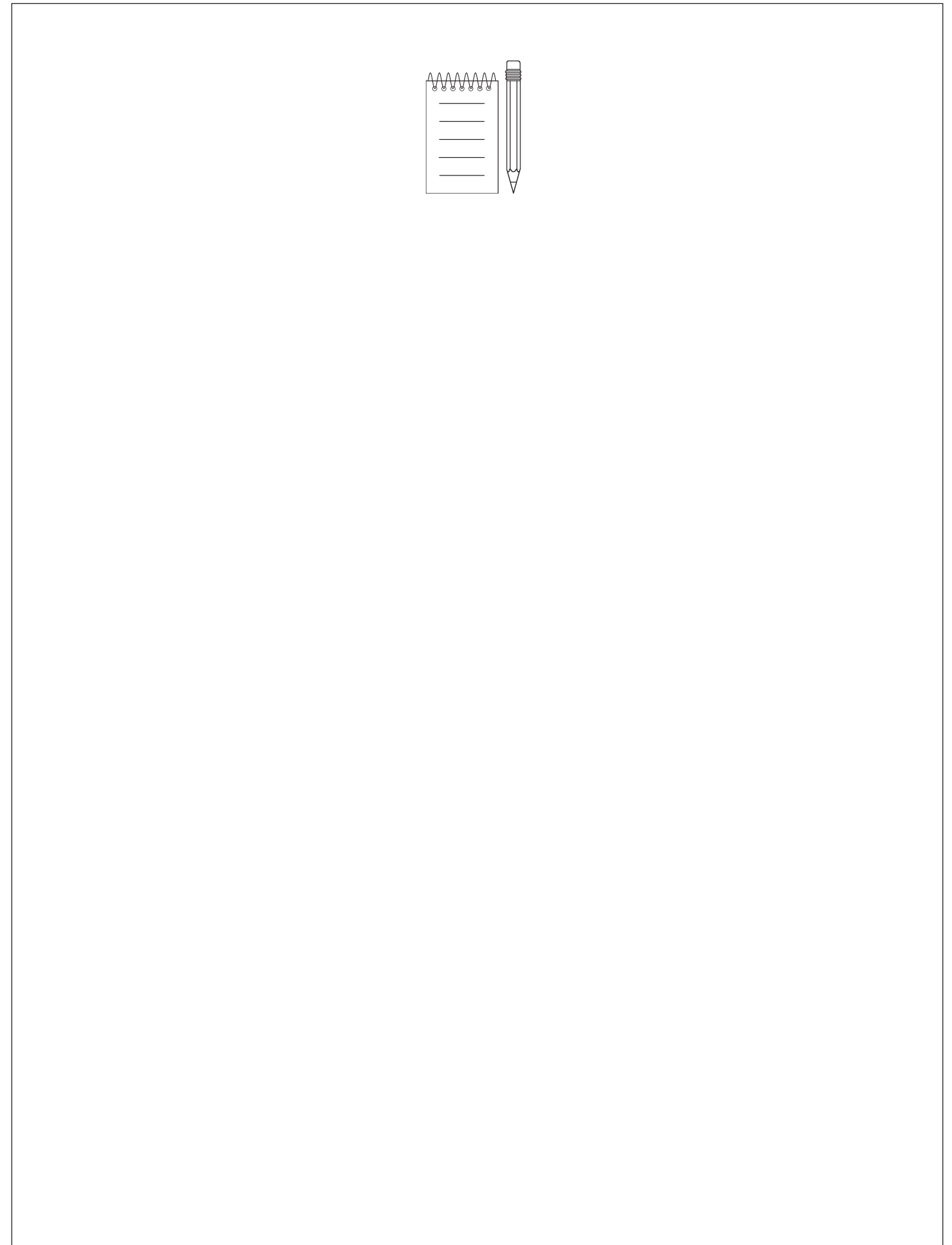
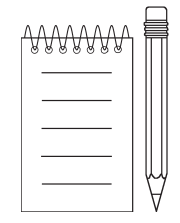
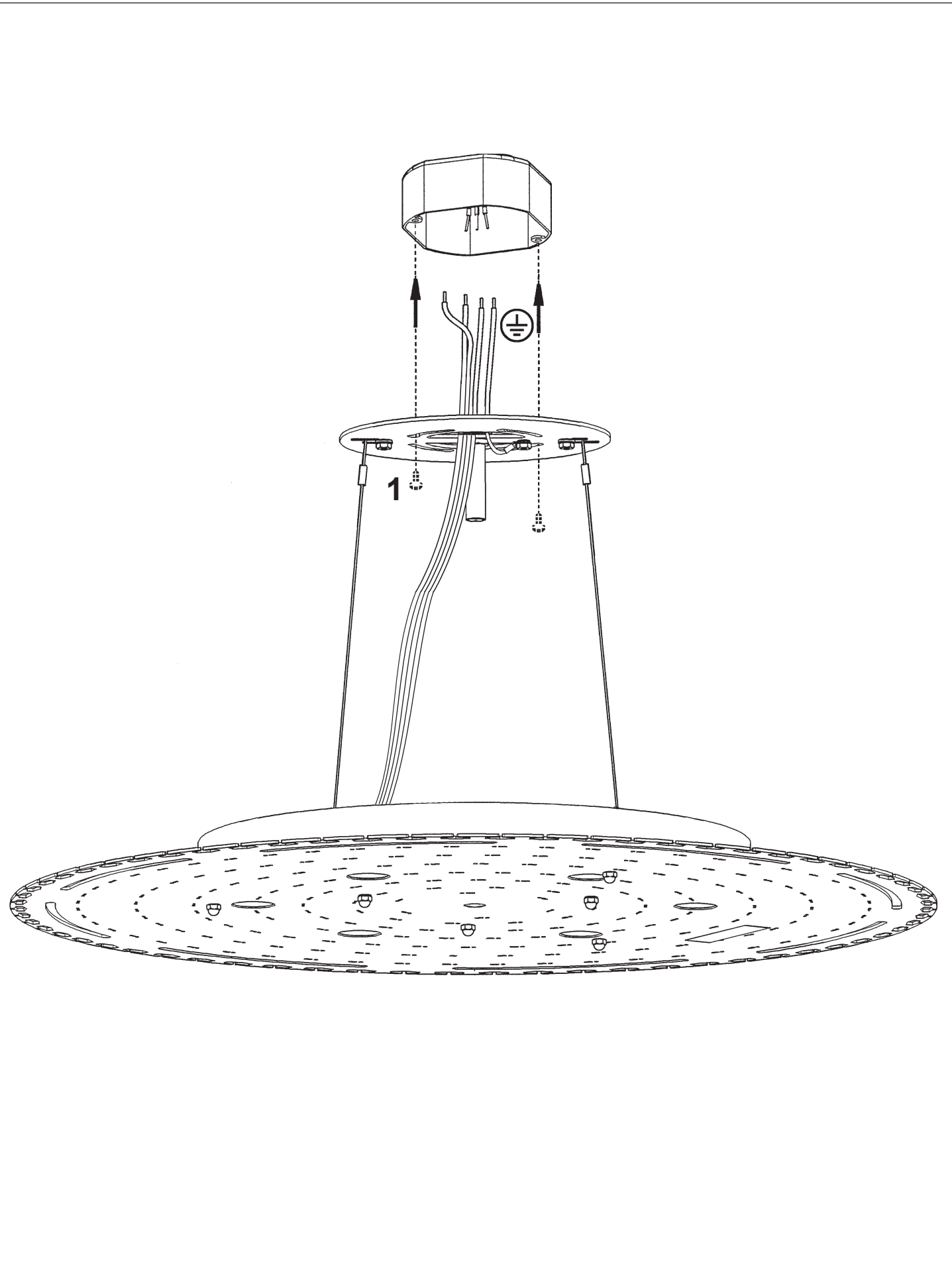

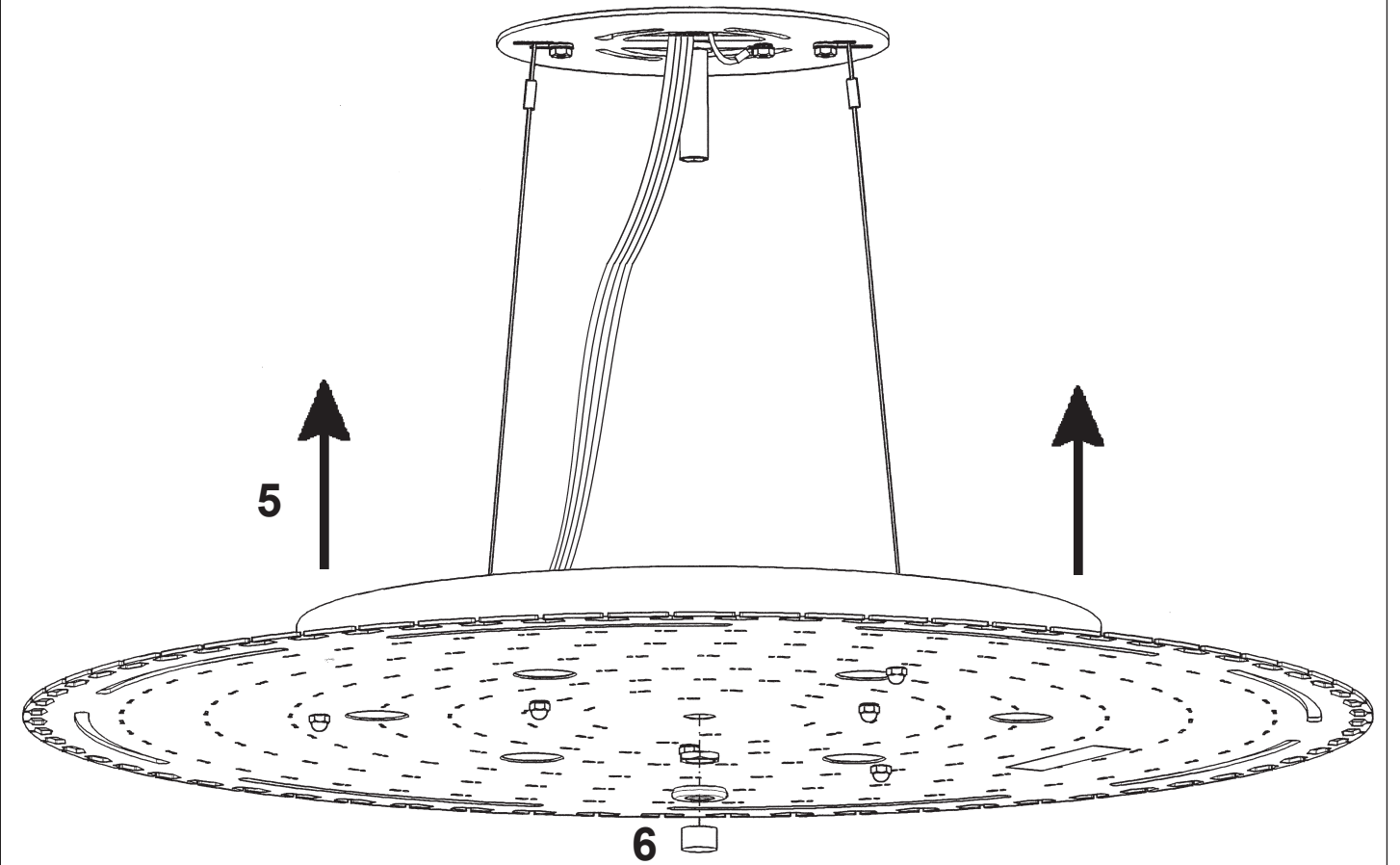
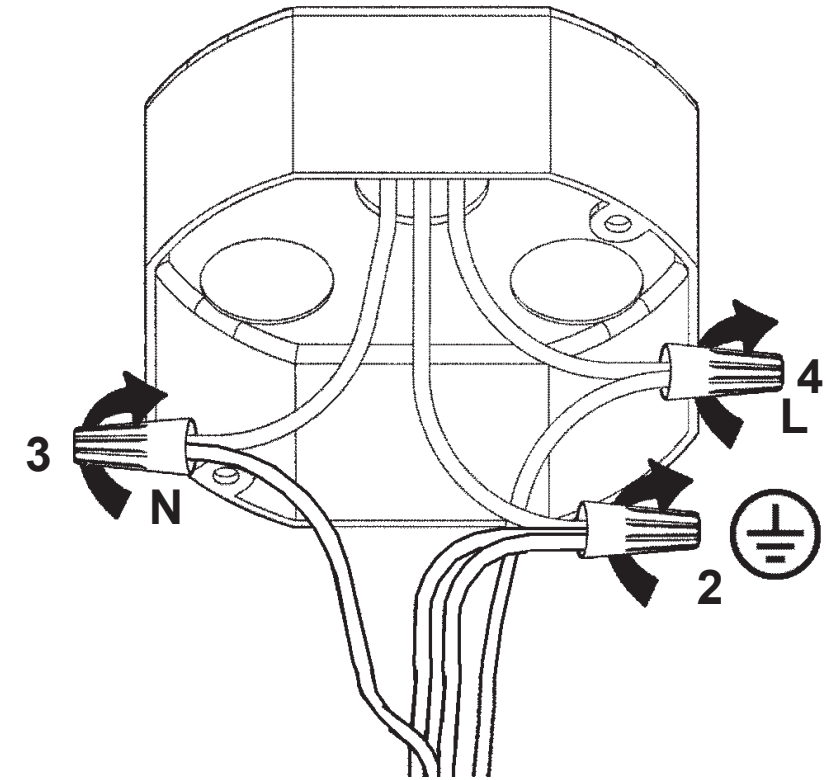
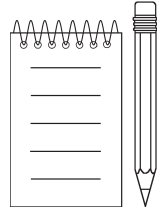

6 X  : GU10 35W MAX 

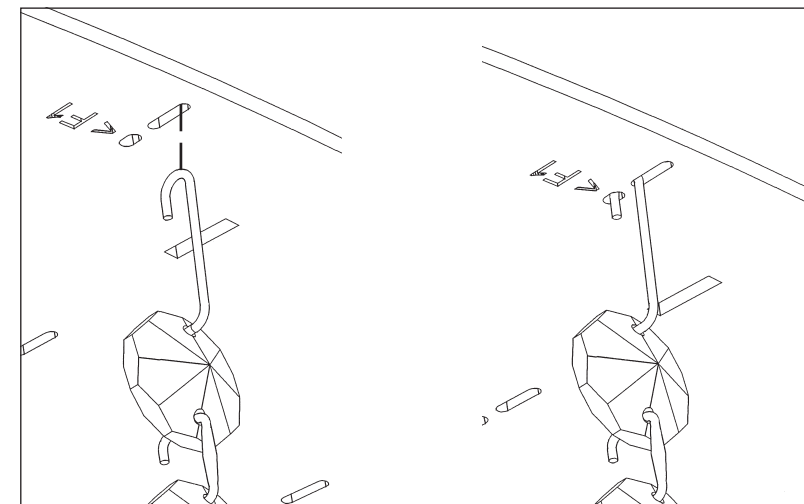
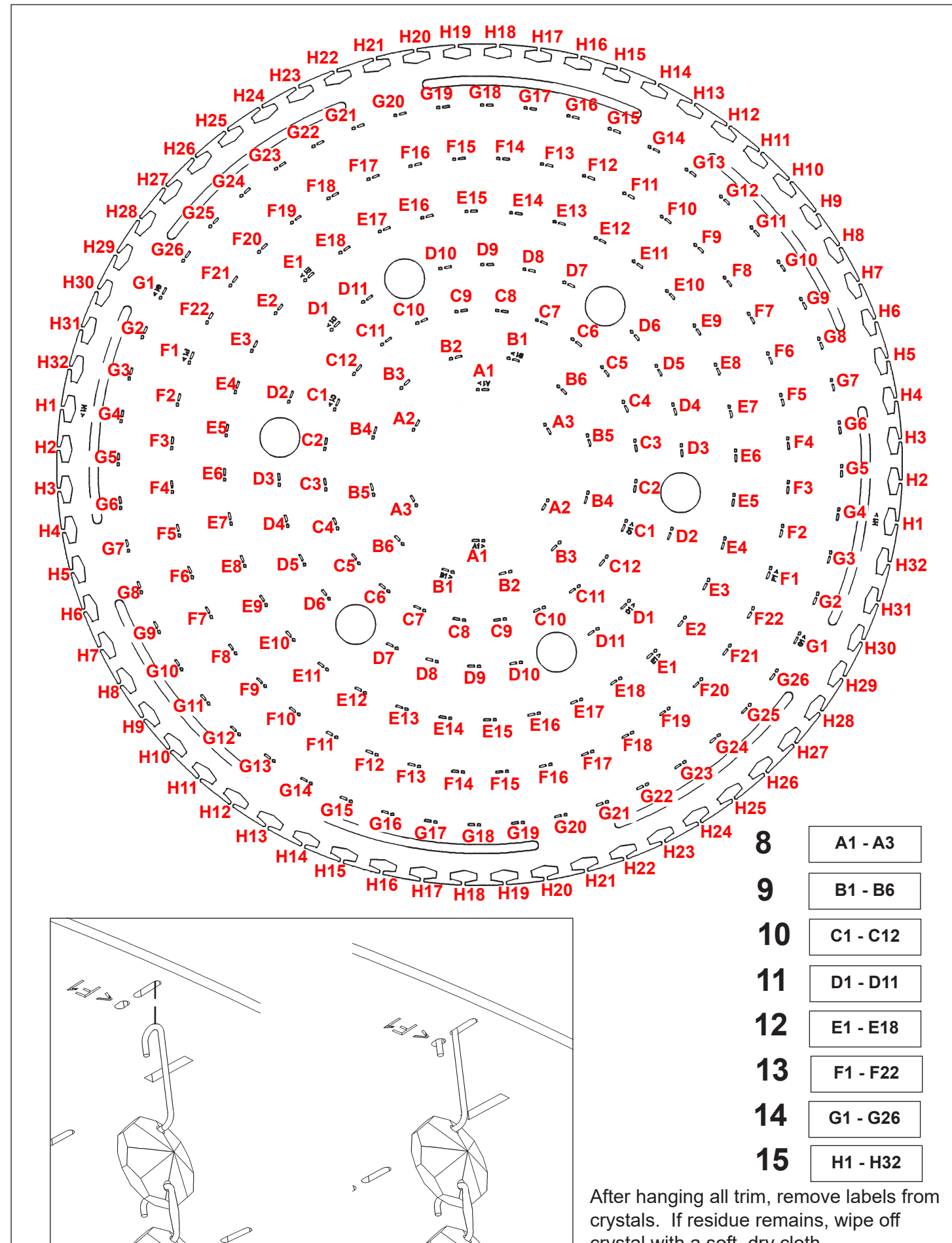
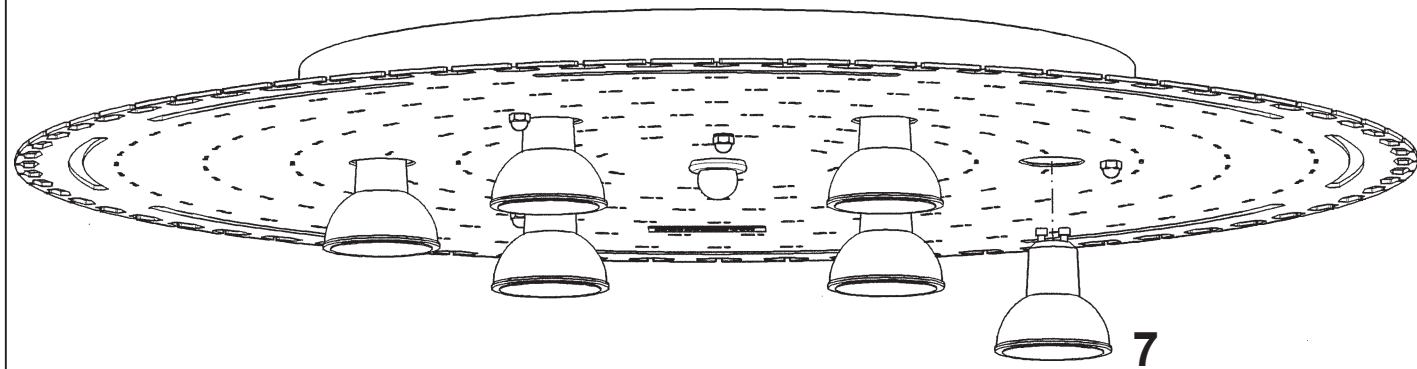

After hanging all trim, remove labels from crystals. If residue remains, wipe off crystal with a soft, dry cloth.