

 **SCHONBEK** | 1870

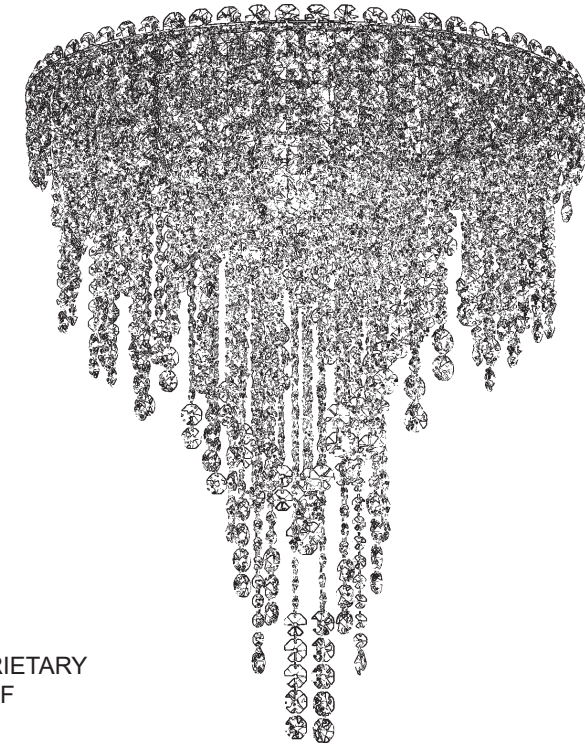









CHANTANT
CH2402N- __ _ O



THIS DESIGN IS THE PROPRIETARY
TRADE DRESS/TRADEMARK OF
W SCHONBEK LLC.



6 Lights
Diameter: 24"
Height: 25"
Hanging Weight: 32lbs.

 **SCHONBEK** | 1870

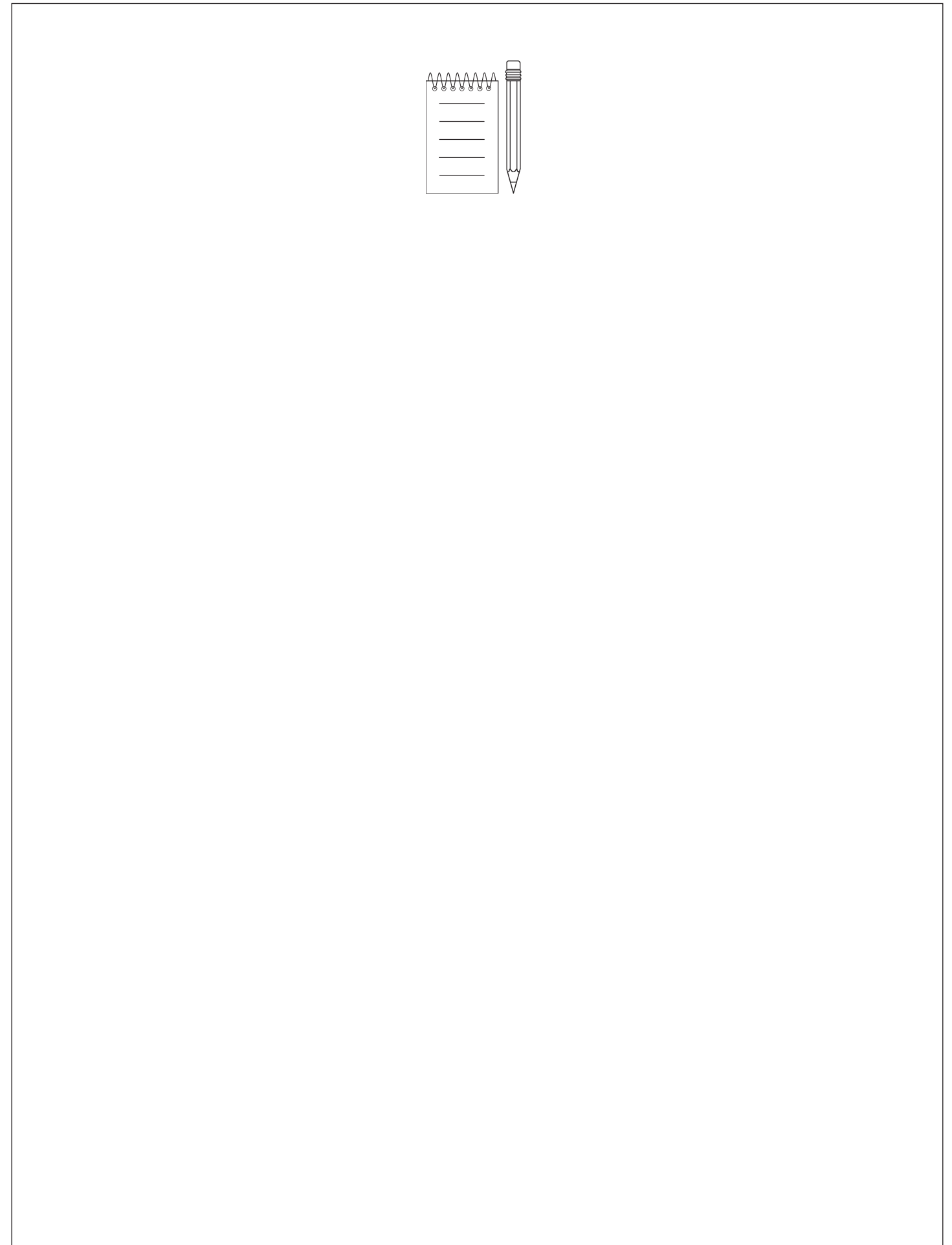
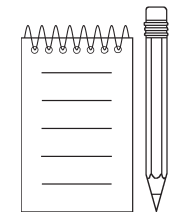
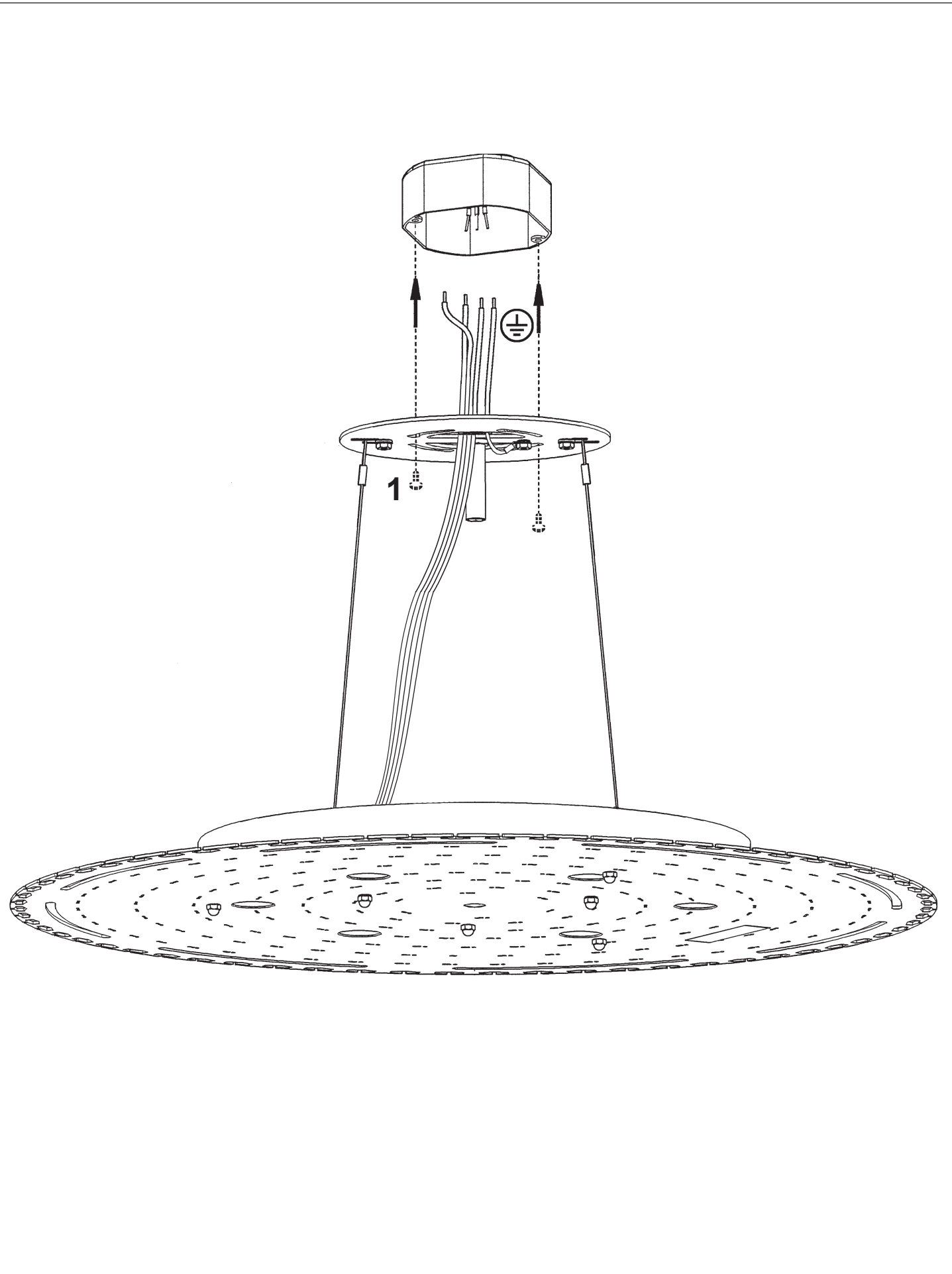
								
MAX 35 W	110-120 V							

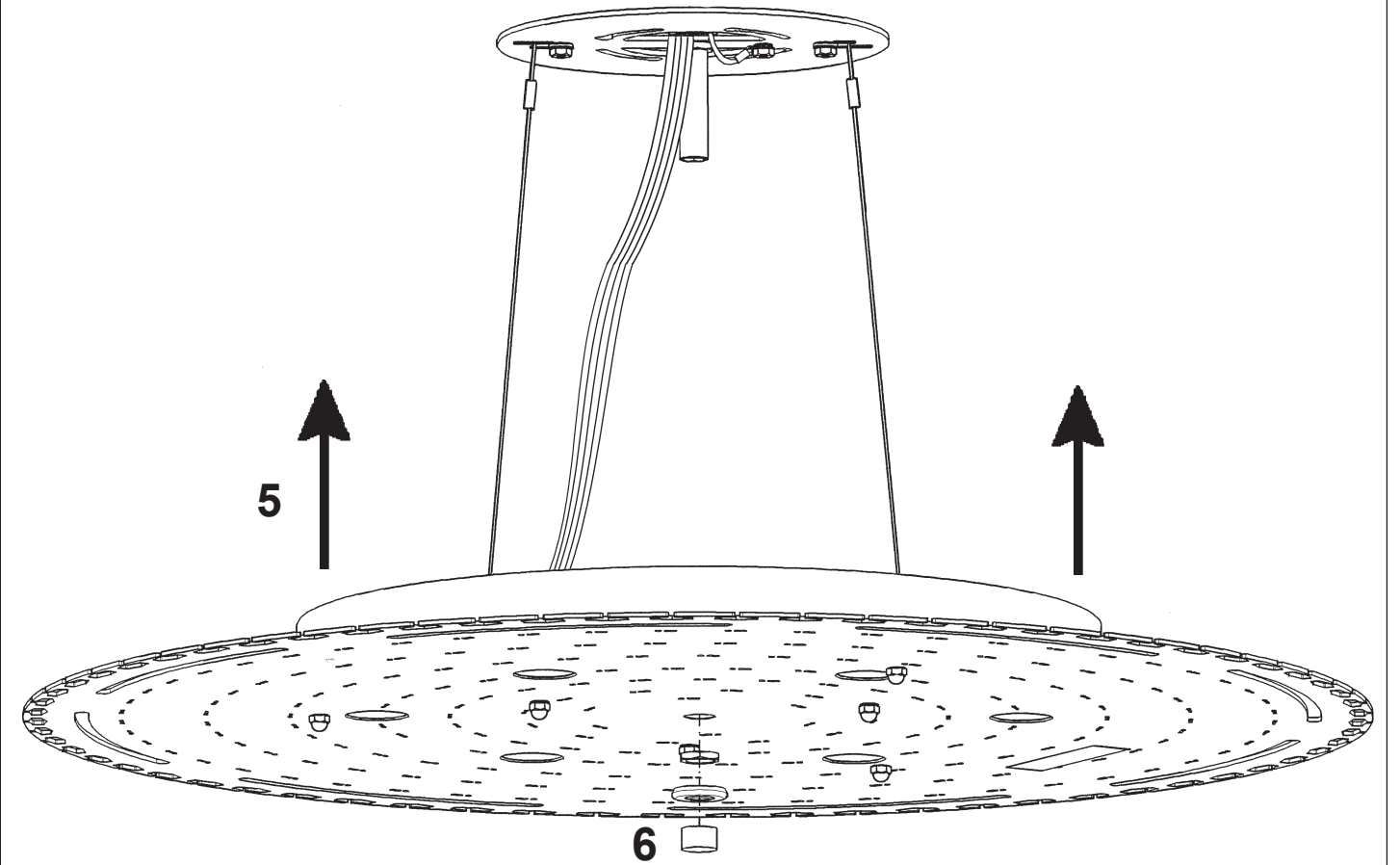
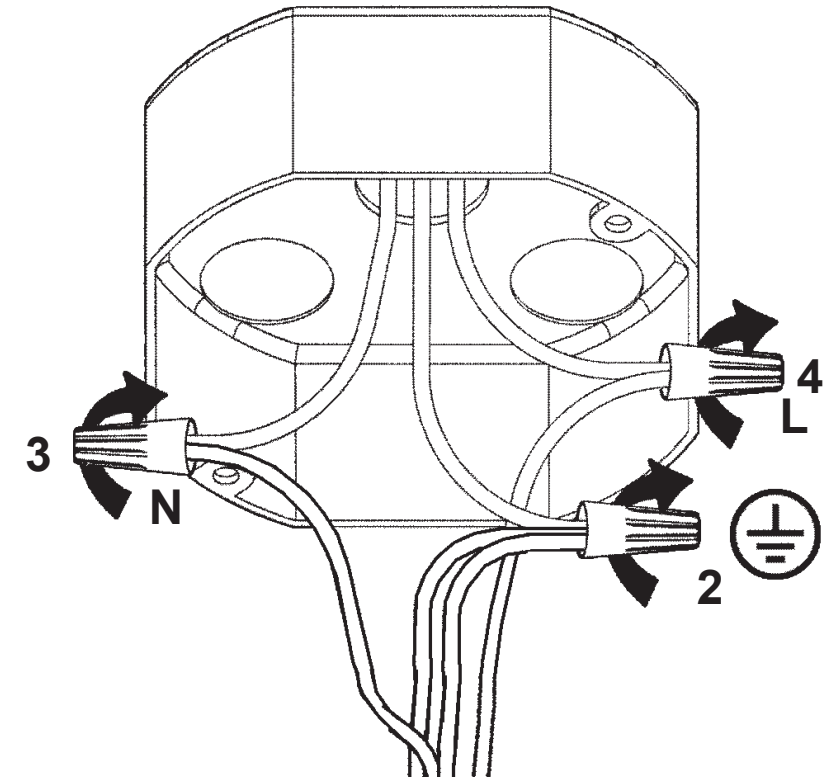
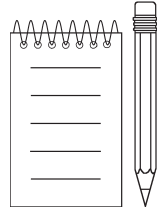

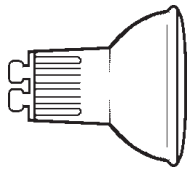

6 X  : GU10 35W MAX 

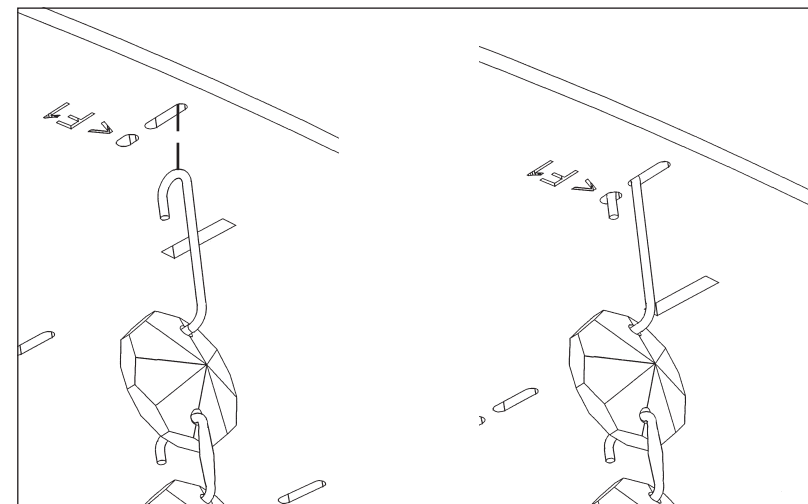
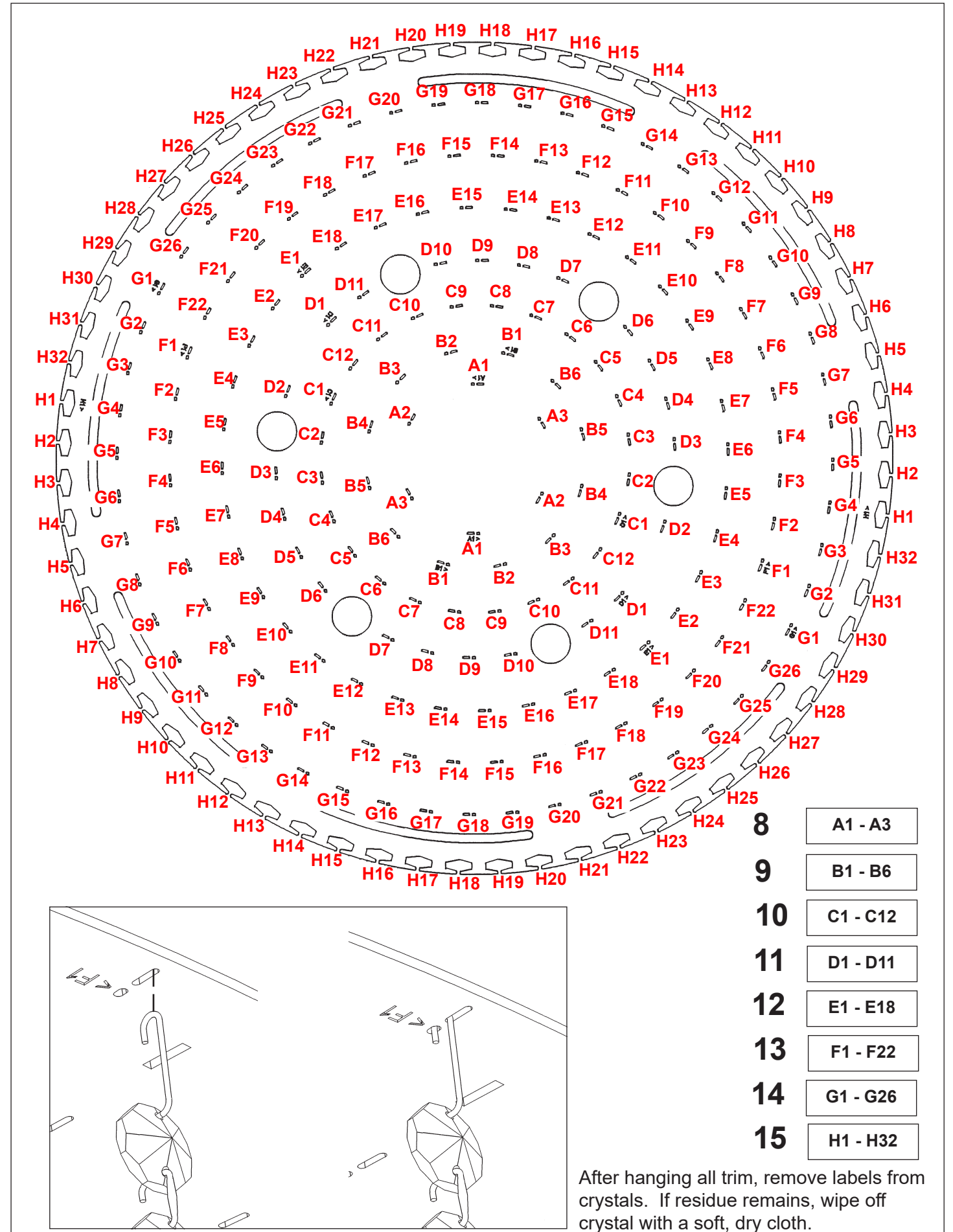
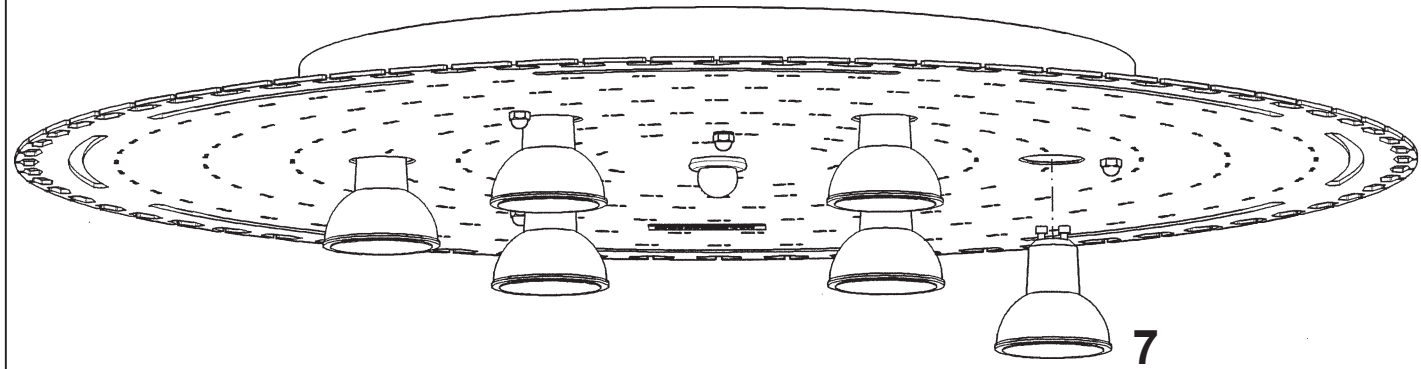

After hanging all trim, remove labels from crystals. If residue remains, wipe off crystal with a soft, dry cloth.

 **SCHONBEK** | 1870



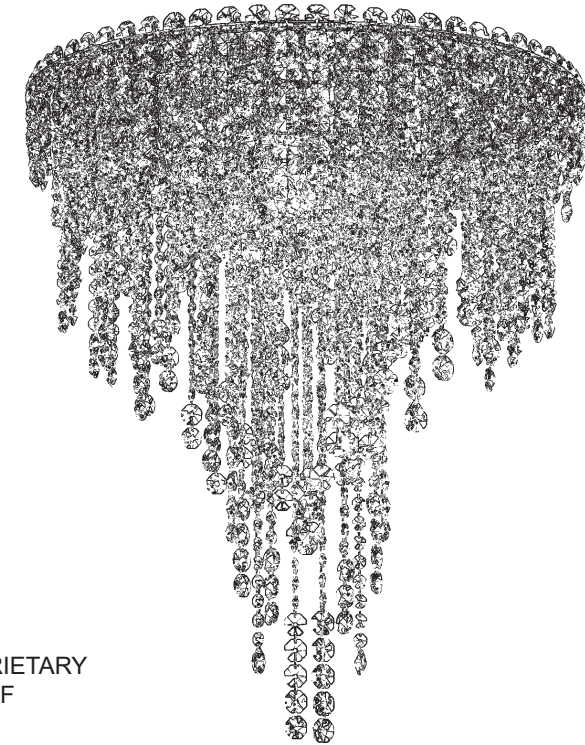





CHANTANT
CH2402N- __ _ R



THIS DESIGN IS THE PROPRIETARY
TRADE DRESS/TRADEMARK OF
W SCHONBEK LLC.

6 Lights
Diameter: 24"
Height: 25"
Hanging Weight: 32lbs.

 **SCHONBEK** | 1870

			S					
MAX 35 W	110-120 V							

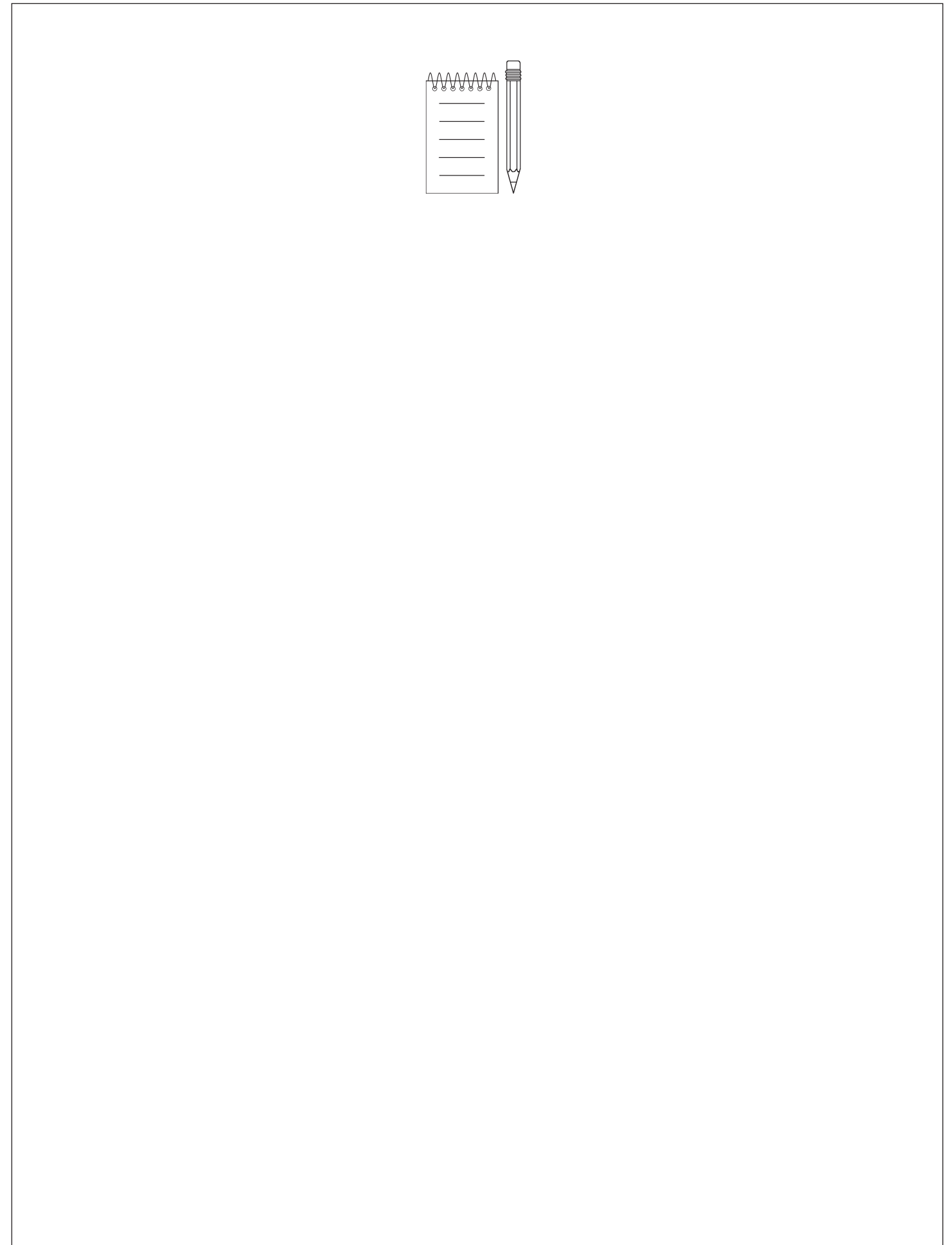
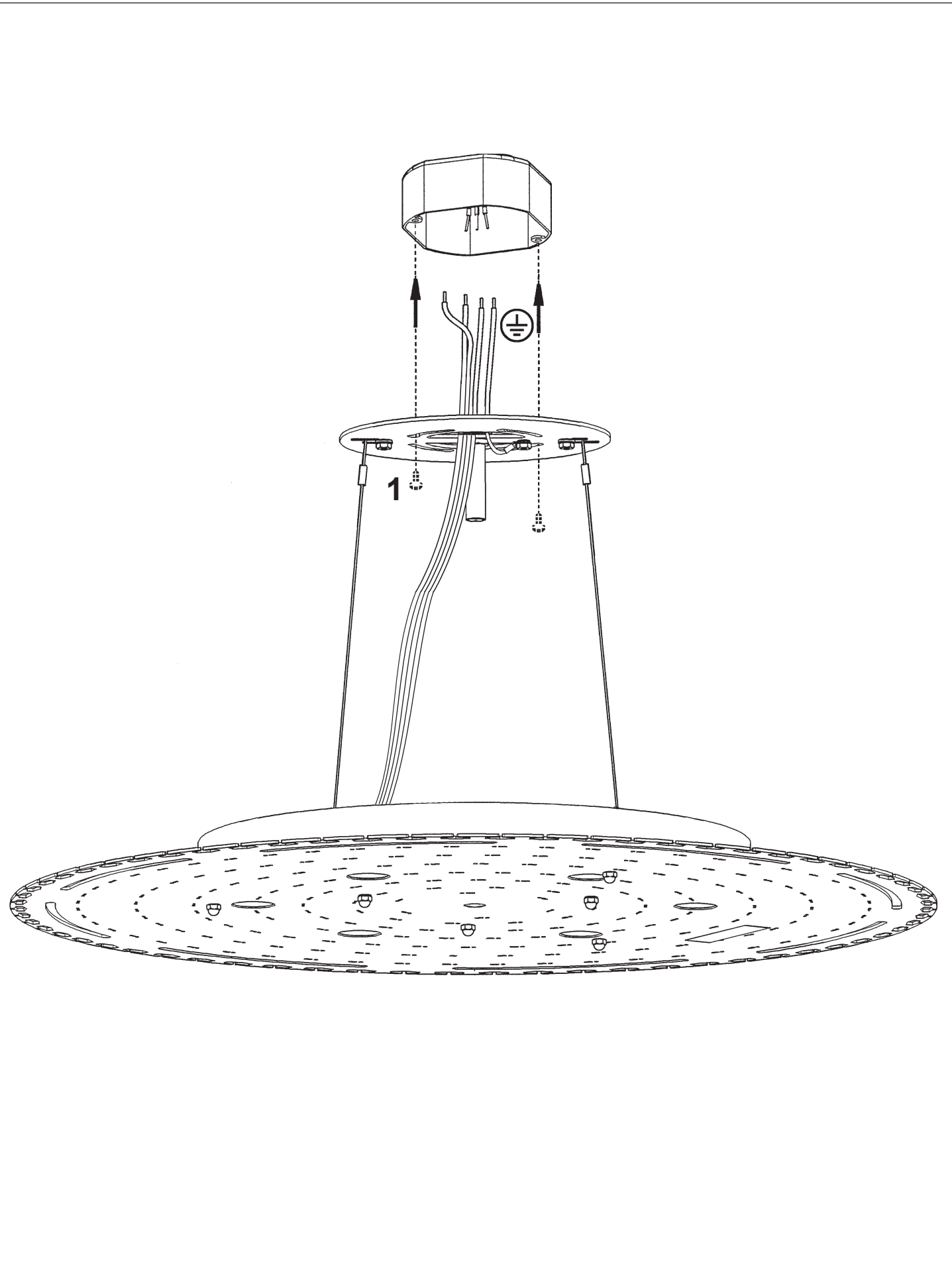

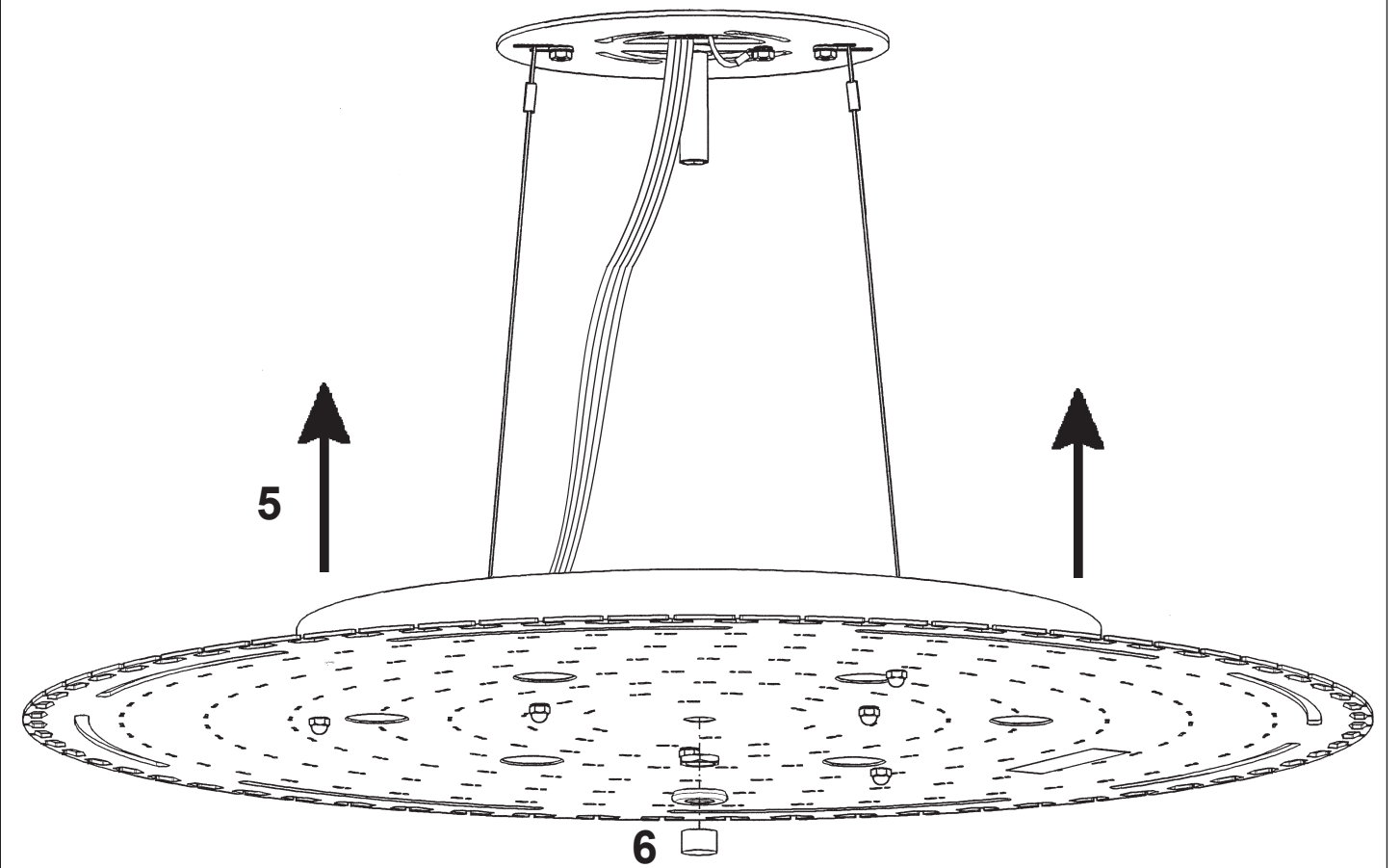
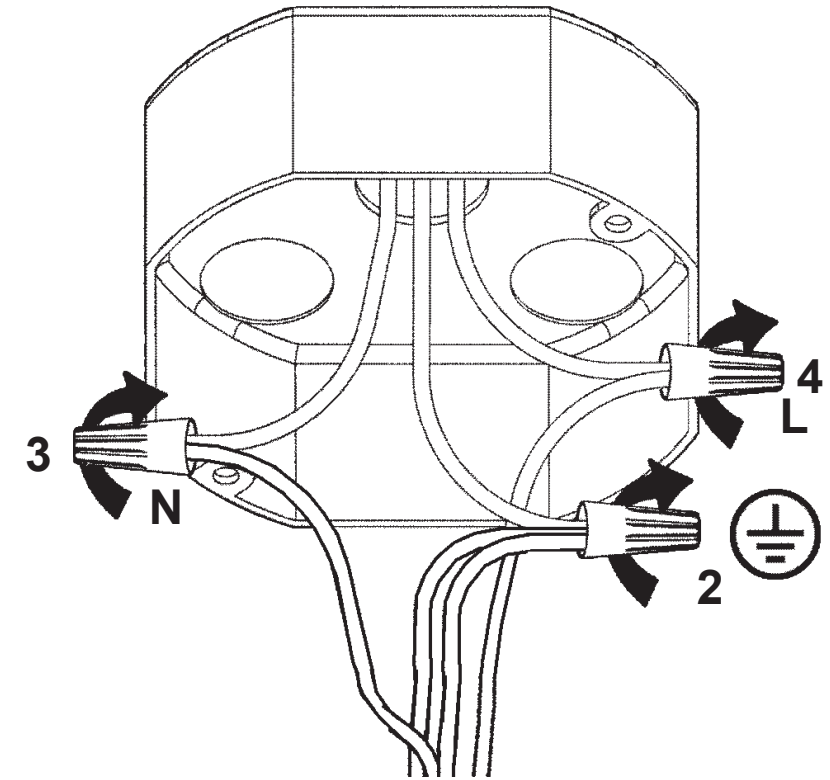
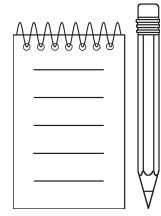

6 X  : GU10 35W MAX 

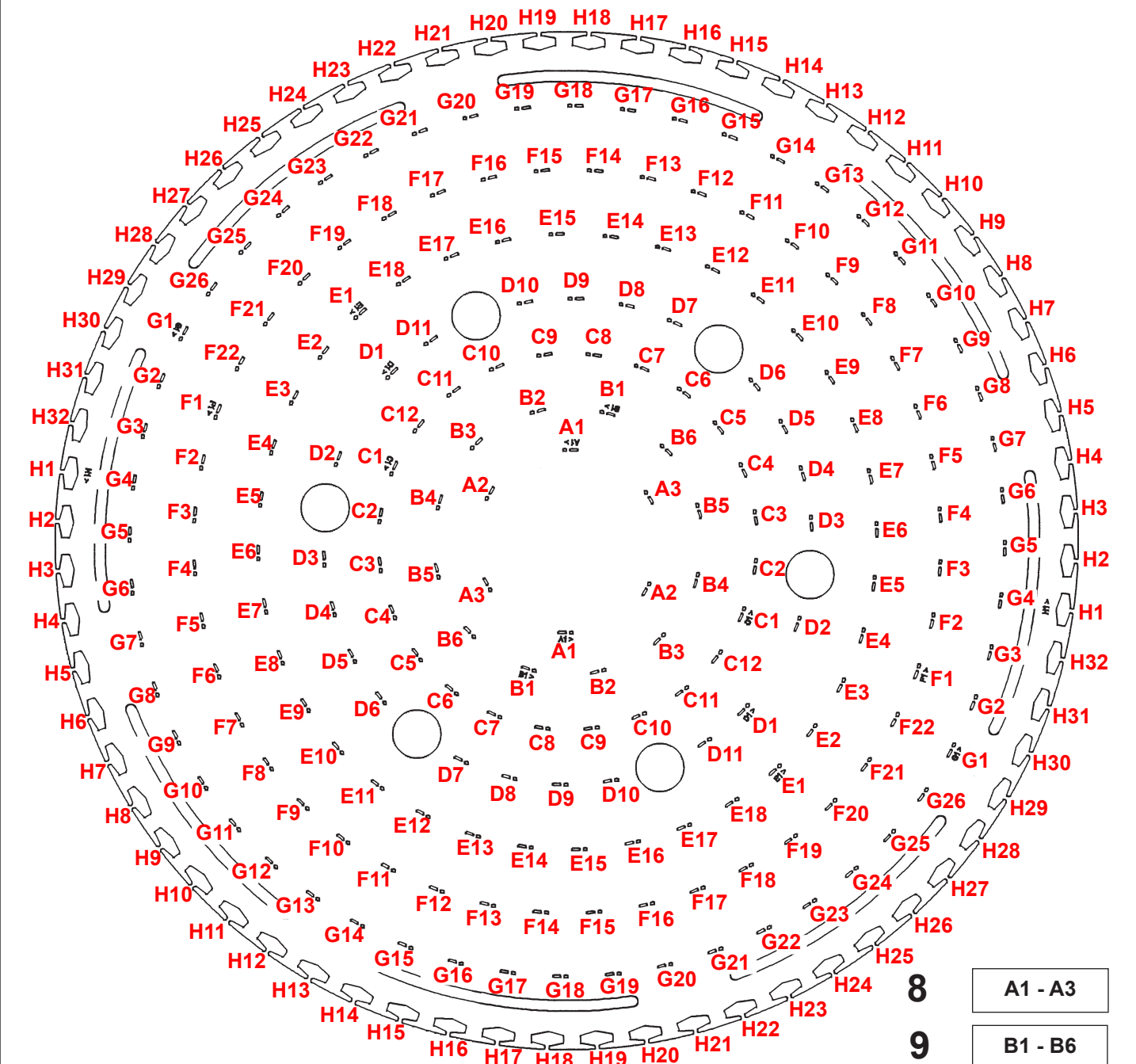
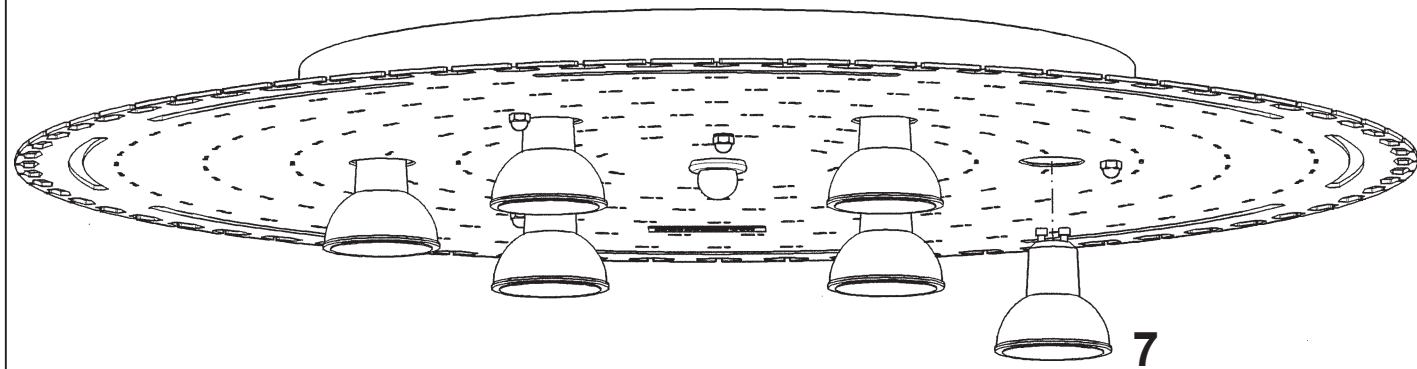

- 8** A1 - A3
- 9** B1 - B6
- 10** C1 - C12
- 11** D1 - D11
- 12** E1 - E18
- 13** F1 - F22
- 14** G1 - G26
- 15** H1 - H32

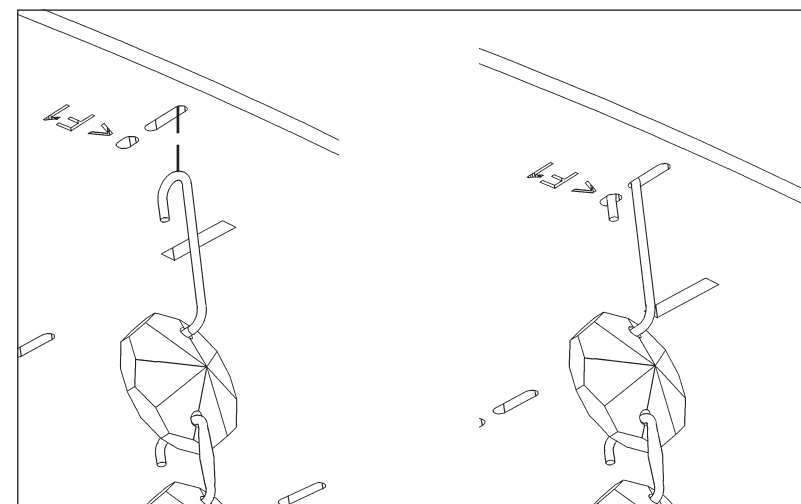

After hanging all trim, remove labels from crystals. If residue remains, wipe off crystal with a soft, dry cloth.