

 **SCHONBEK** | 1870

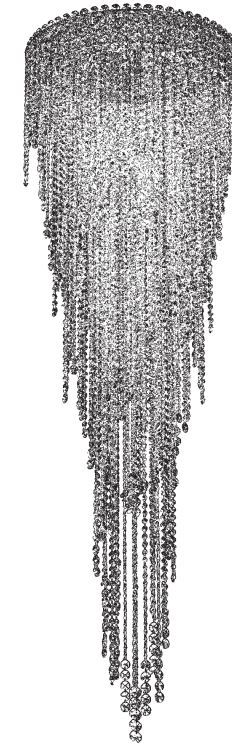









CHANTANT CH2403N- __ _ O



THIS DESIGN IS THE PROPRIETARY
TRADE DRESS/TRADEMARK OF
W SCHONBEK LLC.

6 Lights
Diameter: 24"
Height: 79-1/2"
Hanging Weight: 54lbs.

 **SCHONBEK** | 1870

			S						
MAX 35 W	110-120 V								

NOTE: INSTALLER IS SOLELY RESPONSIBLE FOR PROPER MOUNTING!

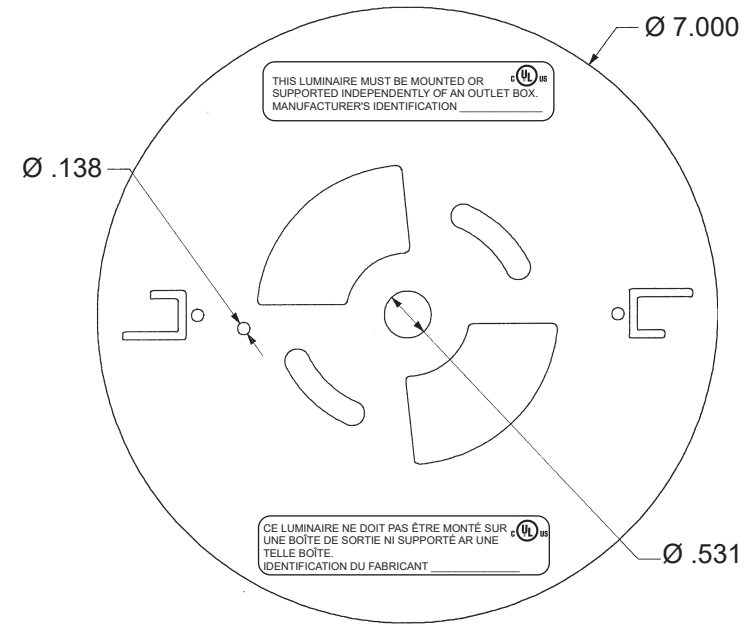

PLAN VIEW OF MOUNTING BRACKET

CROSS MEMBERS
SECURELY FASTENS TO
JOIST OR SIMILAR
STRUCTURE MEMBER

$\varnothing 1/4-20$ THREADED ROD

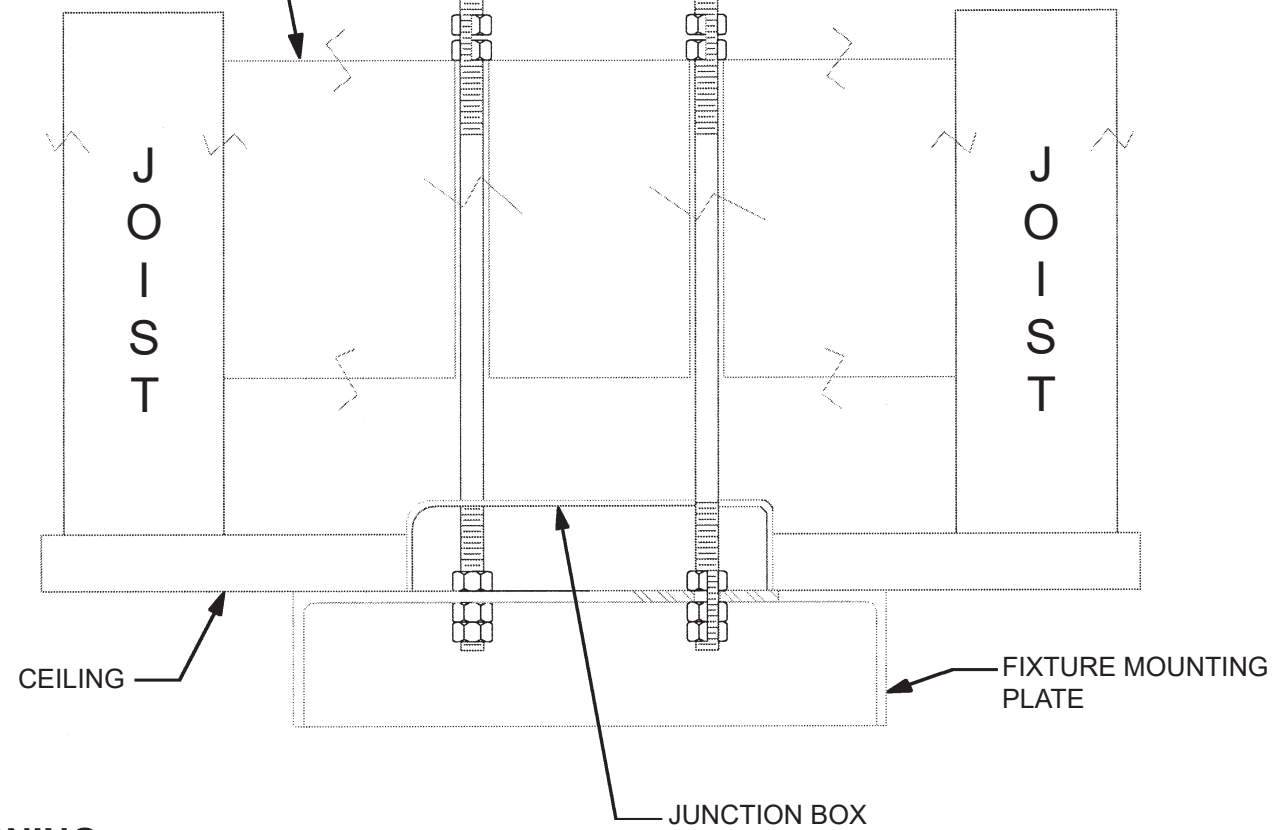

WARNING:
MOUNTING CONFIGURATION AND HARDWARE MUST HOLD 4X THE WEIGHT OF THE FIXTURE. MOUNTING DESIGN AND FIXTURE INSTALLATION SHOULD BE CONDUCTED BY A QUALIFIED LICENSED PROFESSIONAL.

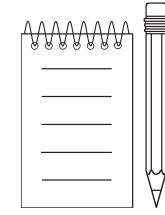

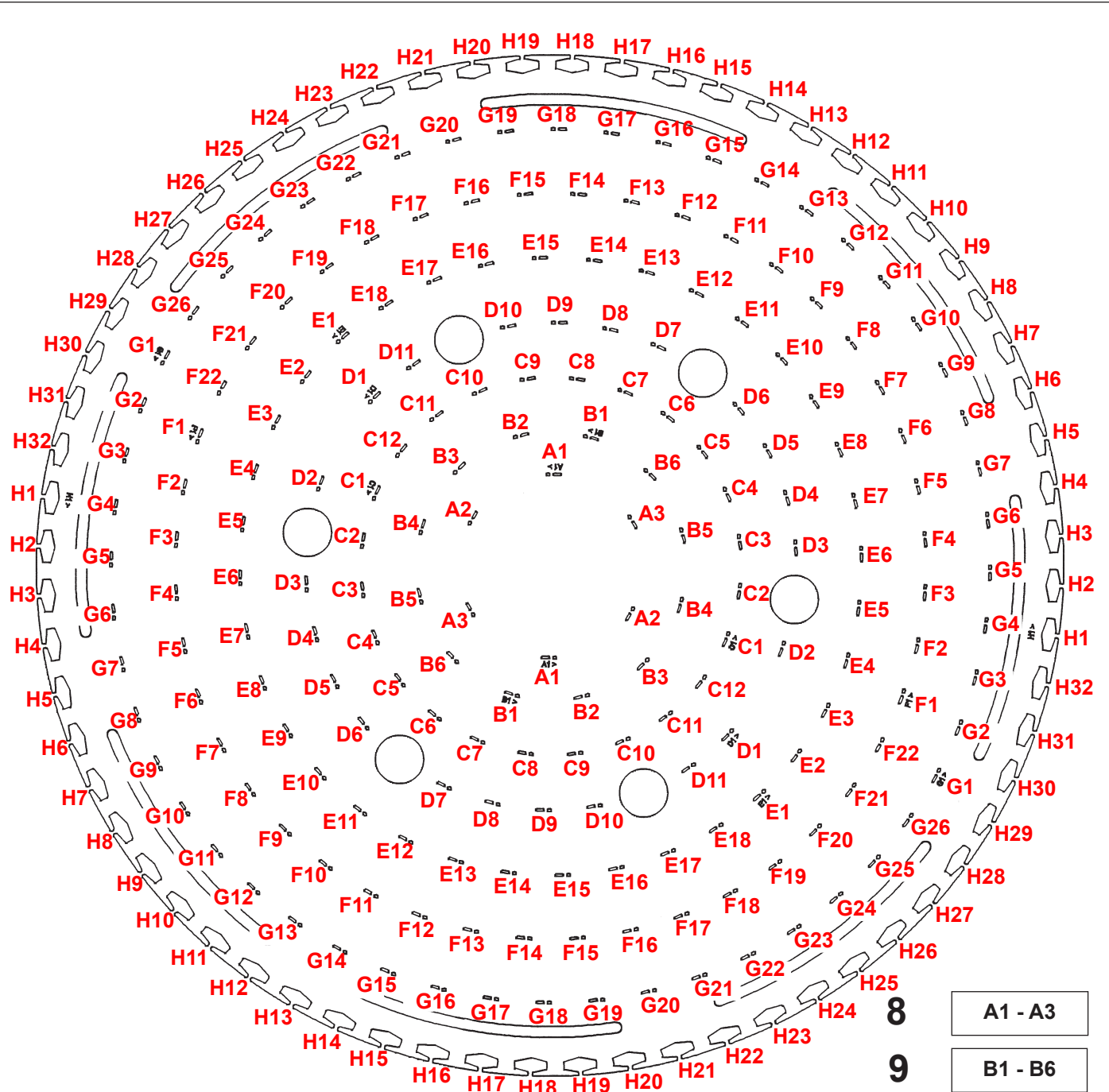

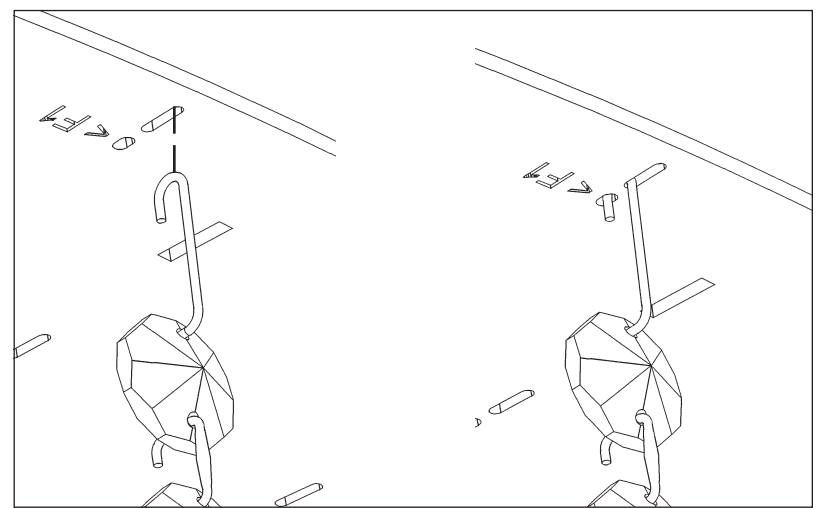

- 8** A1 - A3
- 9** B1 - B6
- 10** C1 - C12
- 11** D1 - D11
- 12** E1 - E18
- 13** F1 - F22
- 14** G1 - G26
- 15** H1 - H32

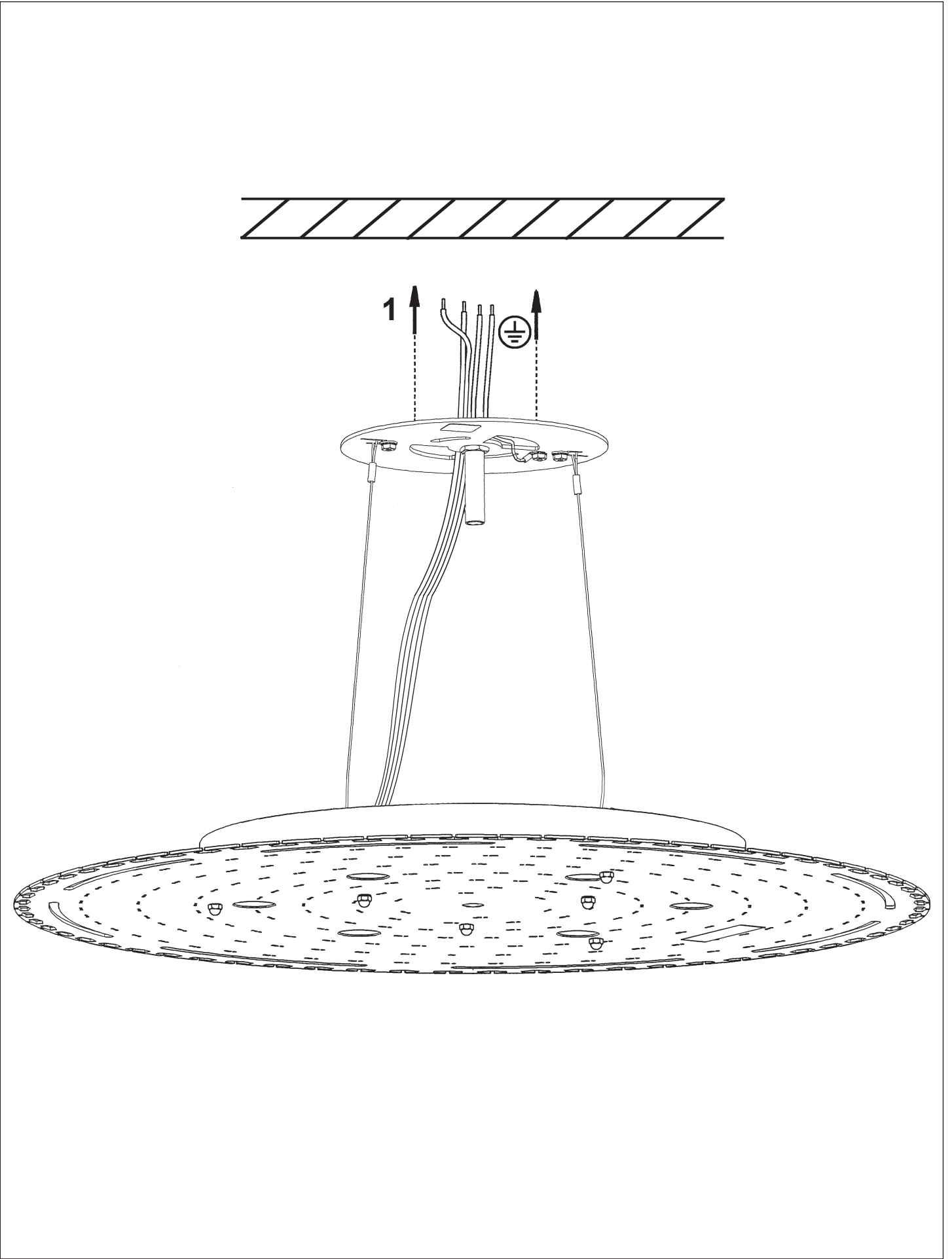

After hanging all trim, remove labels from crystals. If residue remains, wipe off crystal with a soft, dry cloth.

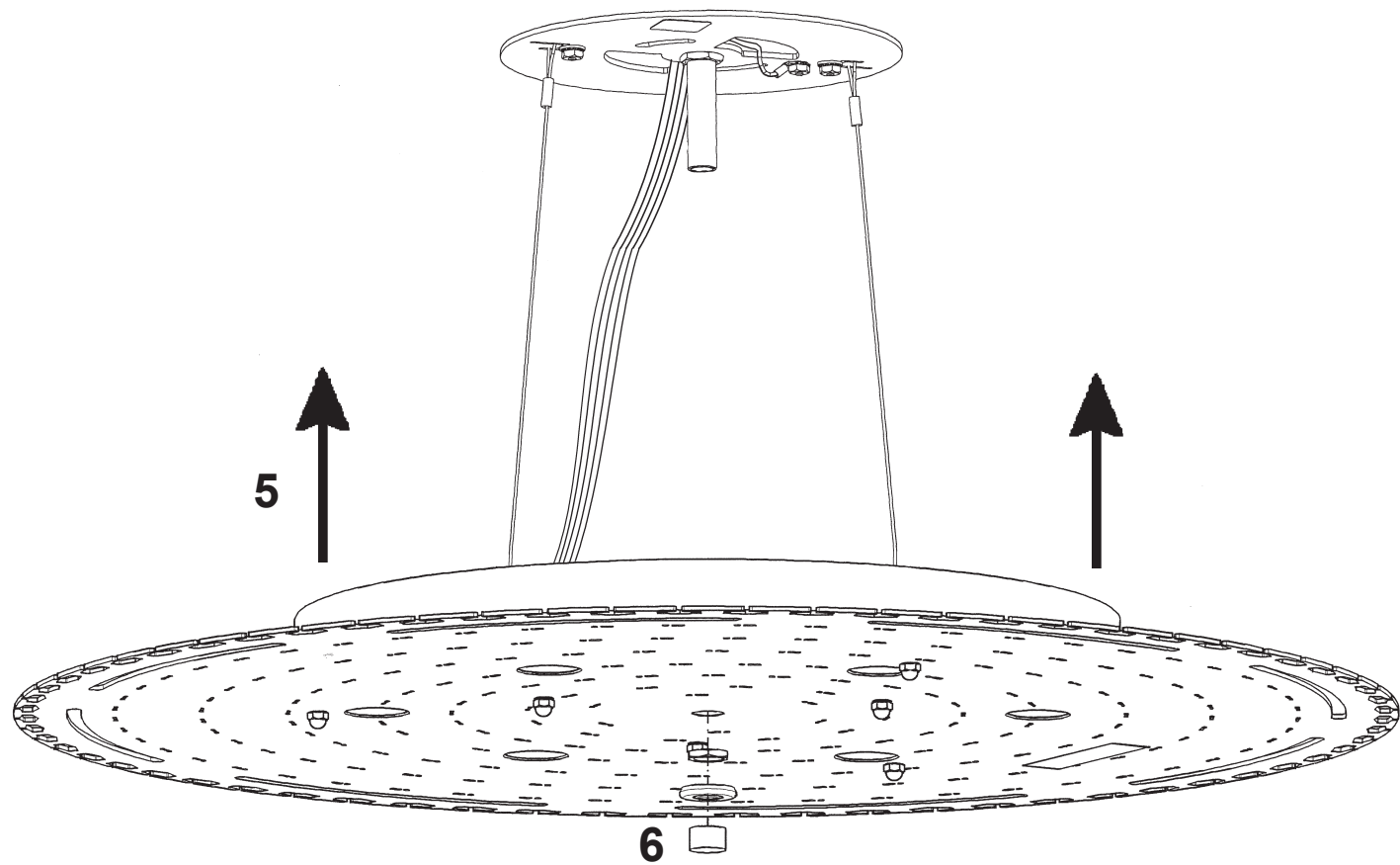
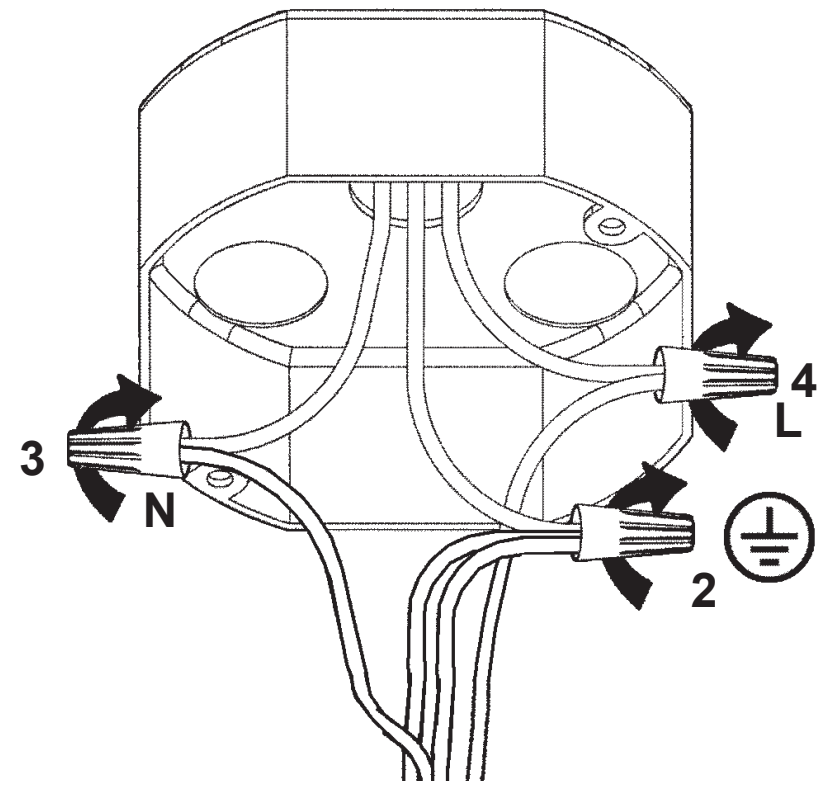

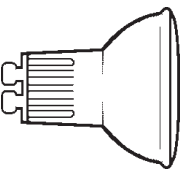

6 X  : GU10 35W MAX 

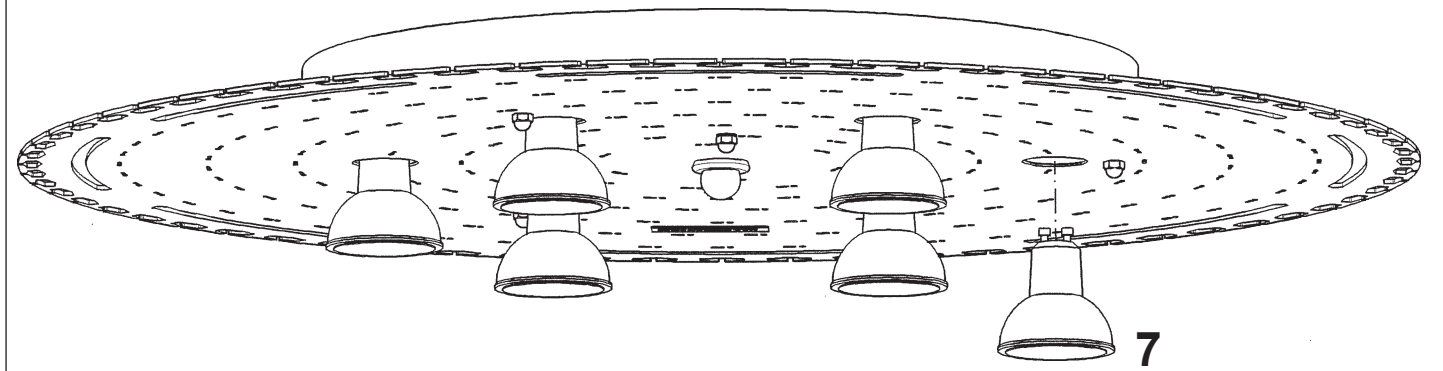

 **SCHONBEK** | 1870



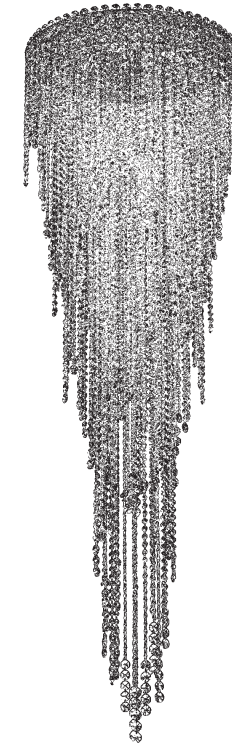







CHANTANT CH2403N- __ _R



THIS DESIGN IS THE PROPRIETARY
TRADE DRESS/TRADEMARK OF
W SCHONBEK LLC.

6 Lights
Diameter: 24"
Height: 79-1/2"
Hanging Weight: 54lbs.

 **SCHONBEK** | 1870

			S						
MAX 35 W	110-120 V								

NOTE: INSTALLER IS SOLELY RESPONSIBLE FOR PROPER MOUNTING!

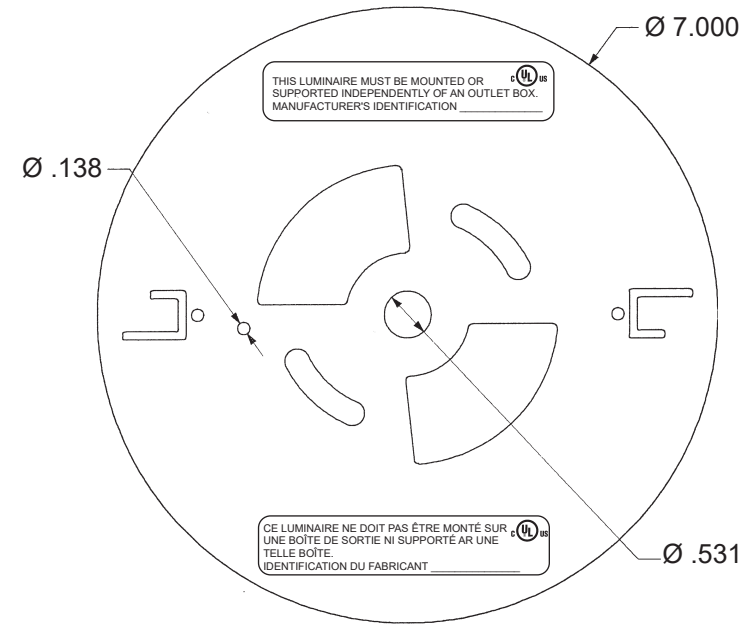

CROSS MEMBERS SECURELY FASTENS TO JOIST OR SIMILAR STRUCTURE MEMBER

PLAN VIEW OF MOUNTING BRACKET

Ø1/4-20 THREADED ROD

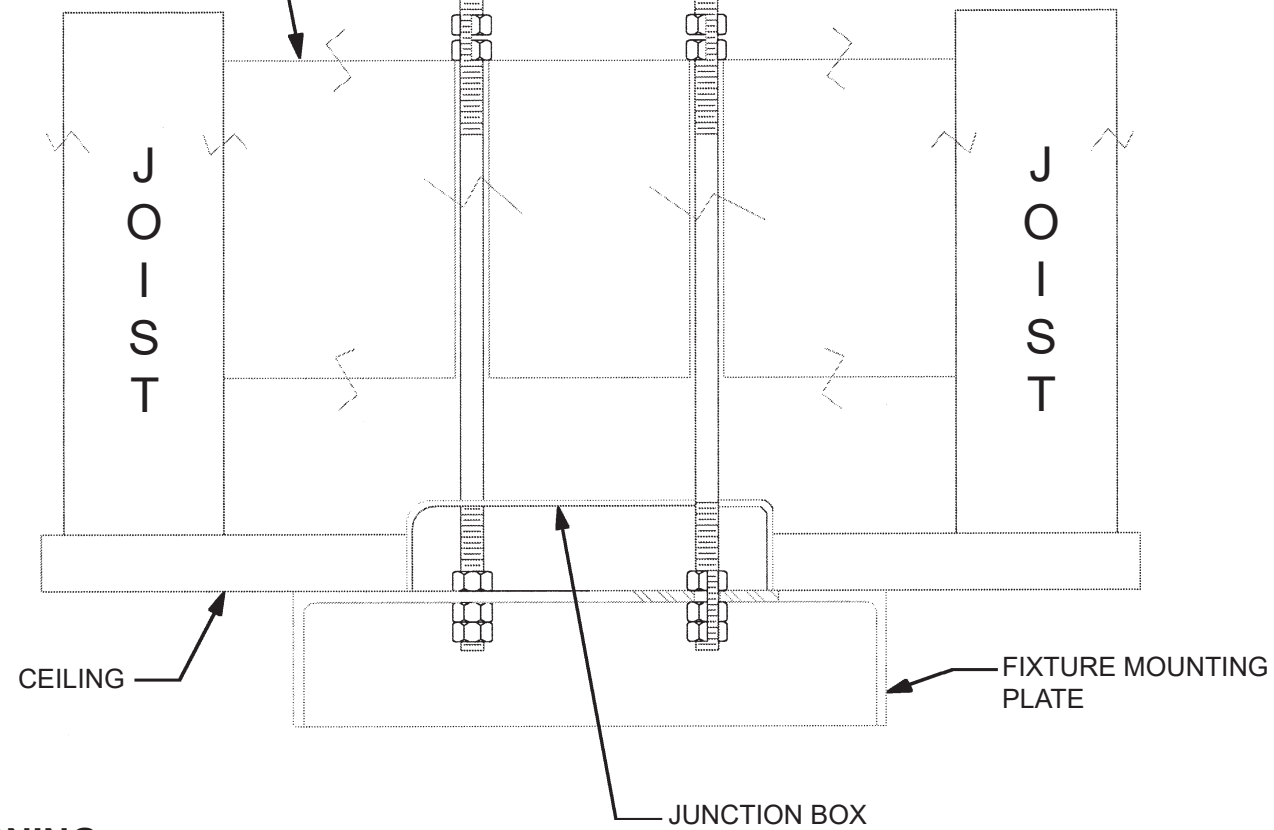

WARNING:
MOUNTING CONFIGURATION AND HARDWARE MUST HOLD 4X THE WEIGHT OF THE FIXTURE. MOUNTING DESIGN AND FIXTURE INSTALLATION SHOULD BE CONDUCTED BY A QUALIFIED LICENSED PROFESSIONAL.

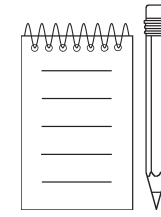

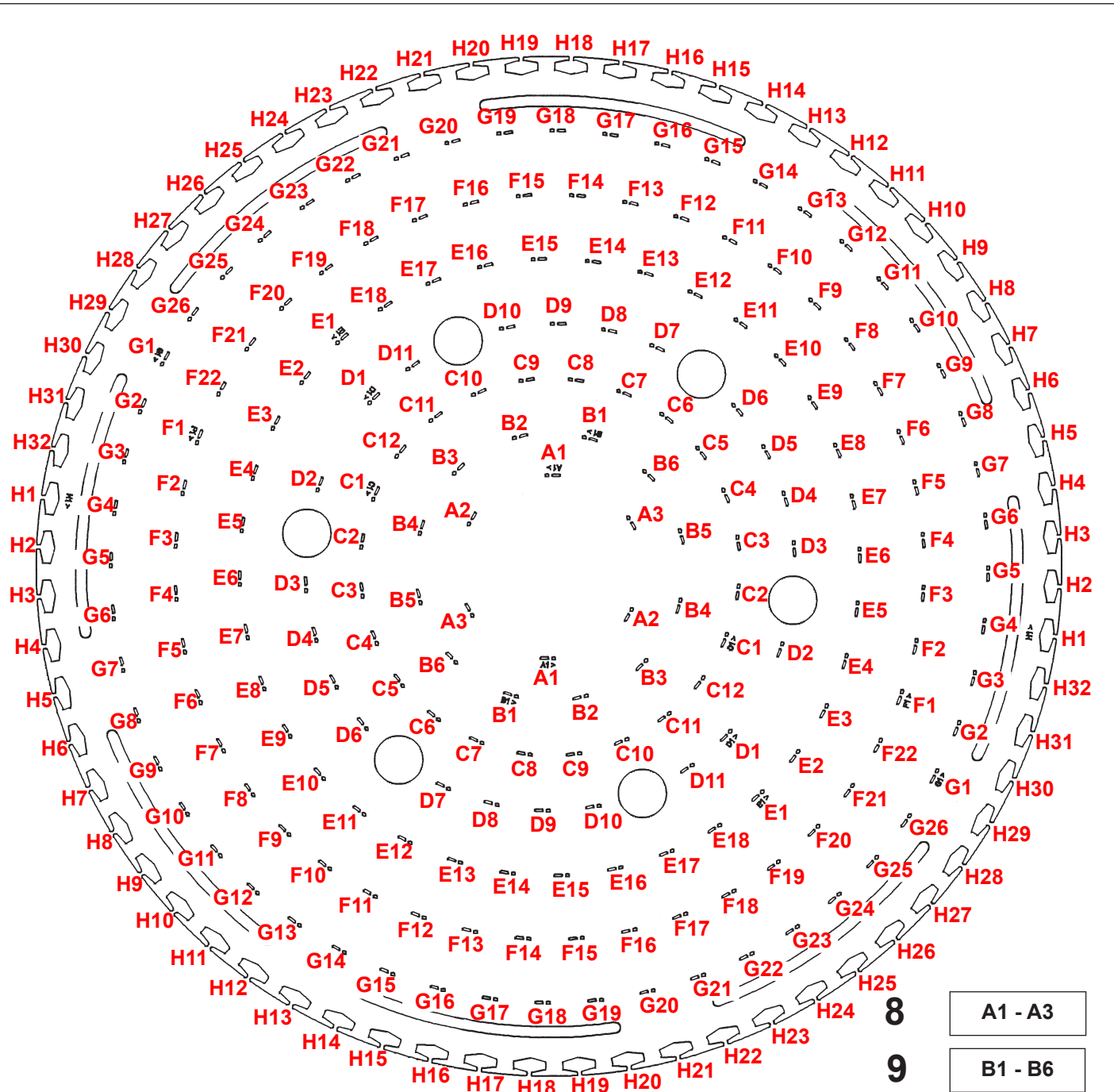

- 8** A1 - A3
- 9** B1 - B6
- 10** C1 - C12
- 11** D1 - D11
- 12** E1 - E18
- 13** F1 - F22
- 14** G1 - G26
- 15** H1 - H32

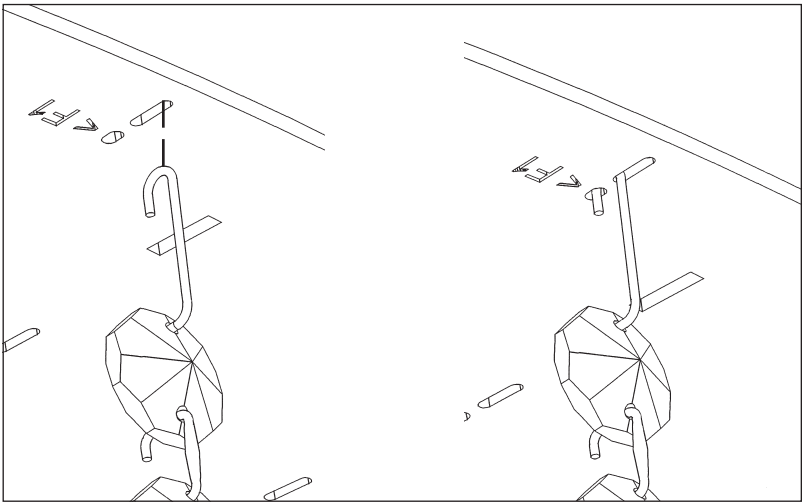

After hanging all trim, remove labels from crystals. If residue remains, wipe off crystal with a soft, dry cloth.

