

 **SCHONBEK** | 1870









CHANTANT
CH4803N- __ _ O



THIS DESIGN IS THE PROPRIETARY
TRADE DRESS/TRADEMARK OF
W SCHONBEK LLC.

8 Lights
Height: 52-1/2"
Length: 43"
Width: 22"
Hanging Weight: 61lbs.

 **SCHONBEK** | 1870

			S					
MAX 35 W	110-120 V							

NOTE: INSTALLER IS SOLELY RESPONSIBLE FOR PROPER MOUNTING!

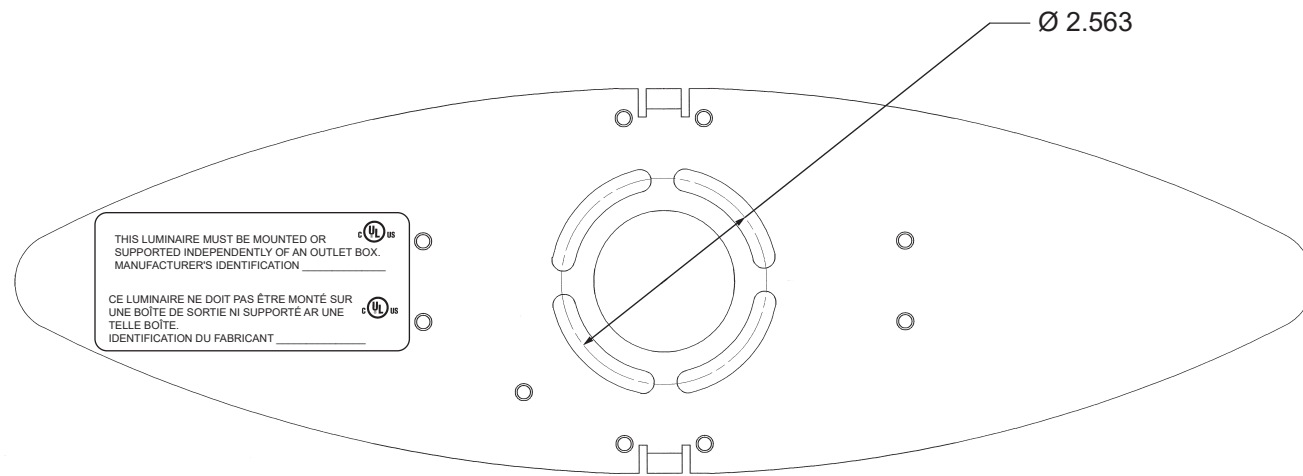

PLAN VIEW OF MOUNTING BRACKET

CROSS MEMBERS SECURELY FASTENS TO JOIST OR SIMILAR STRUCTURE MEMBER

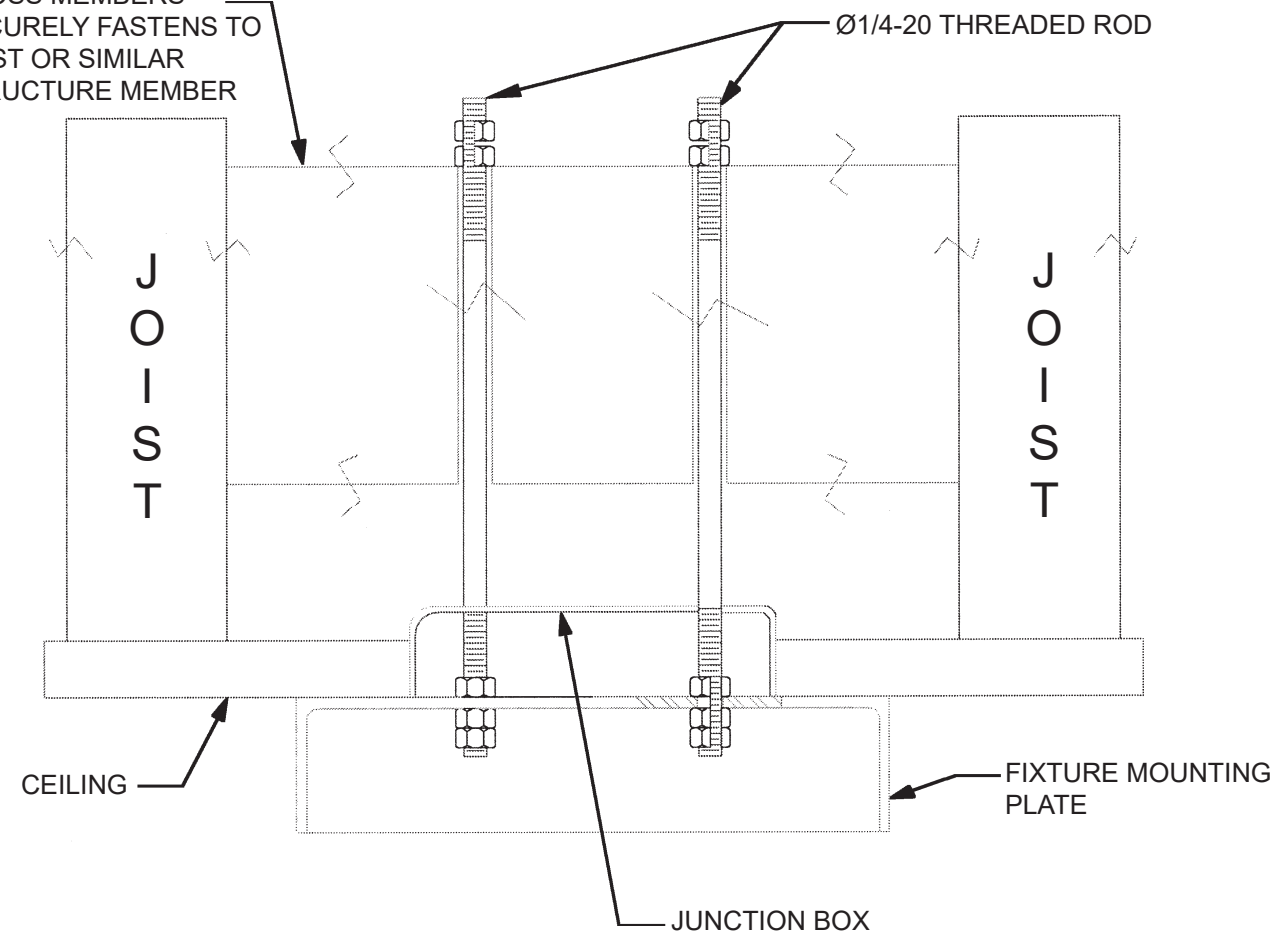

WARNING:

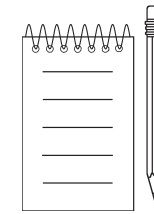

MOUNTING CONFIGURATION AND HARDWARE MUST HOLD 4X THE WEIGHT OF THE FIXTURE. MOUNTING DESIGN AND FIXTURE INSTALLATION SHOULD BE CONDUCTED BY A QUALIFIED LICENSED PROFESSIONAL.

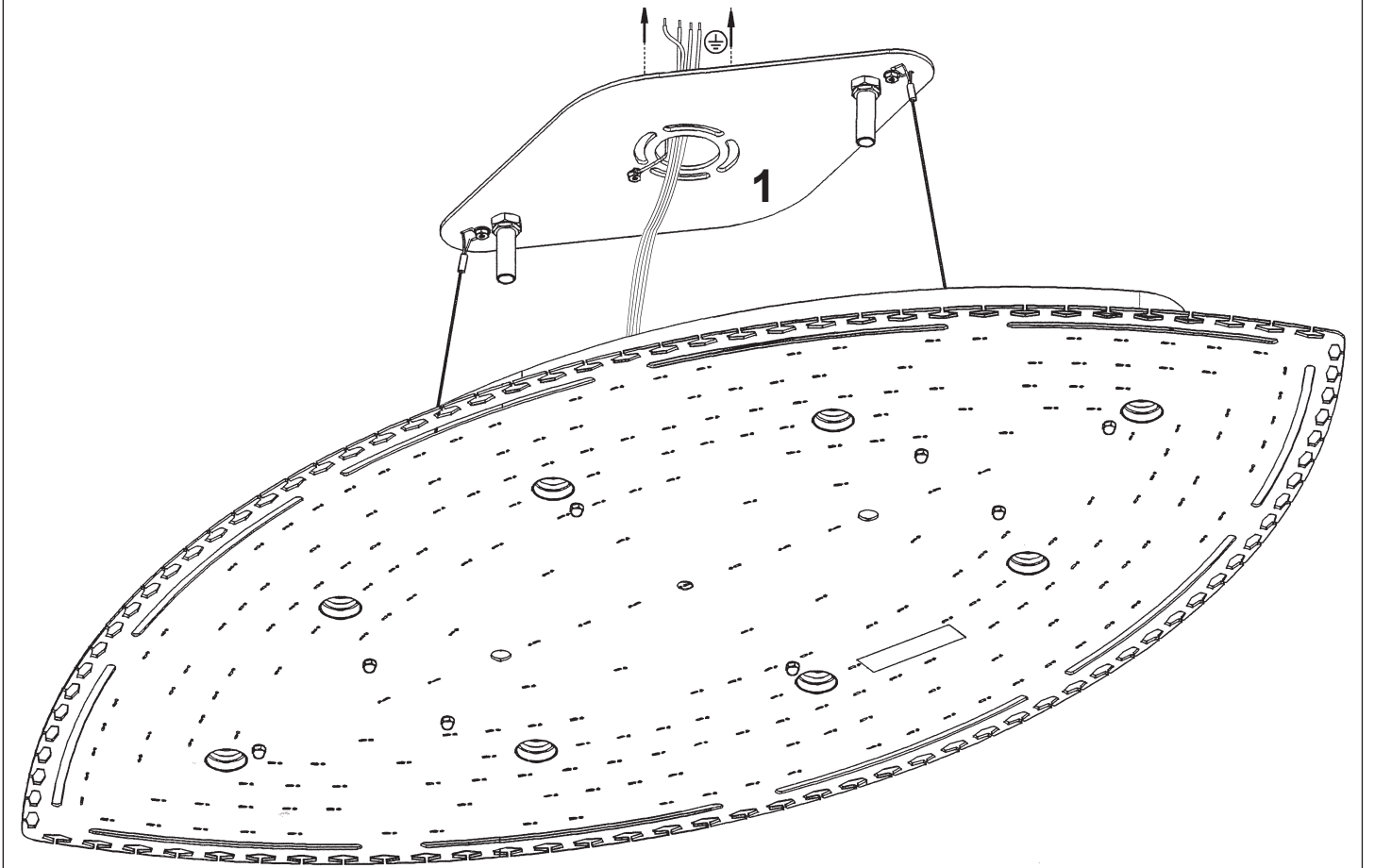
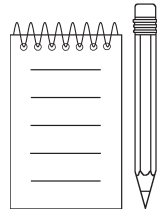

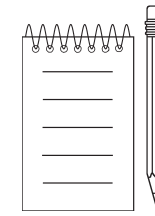
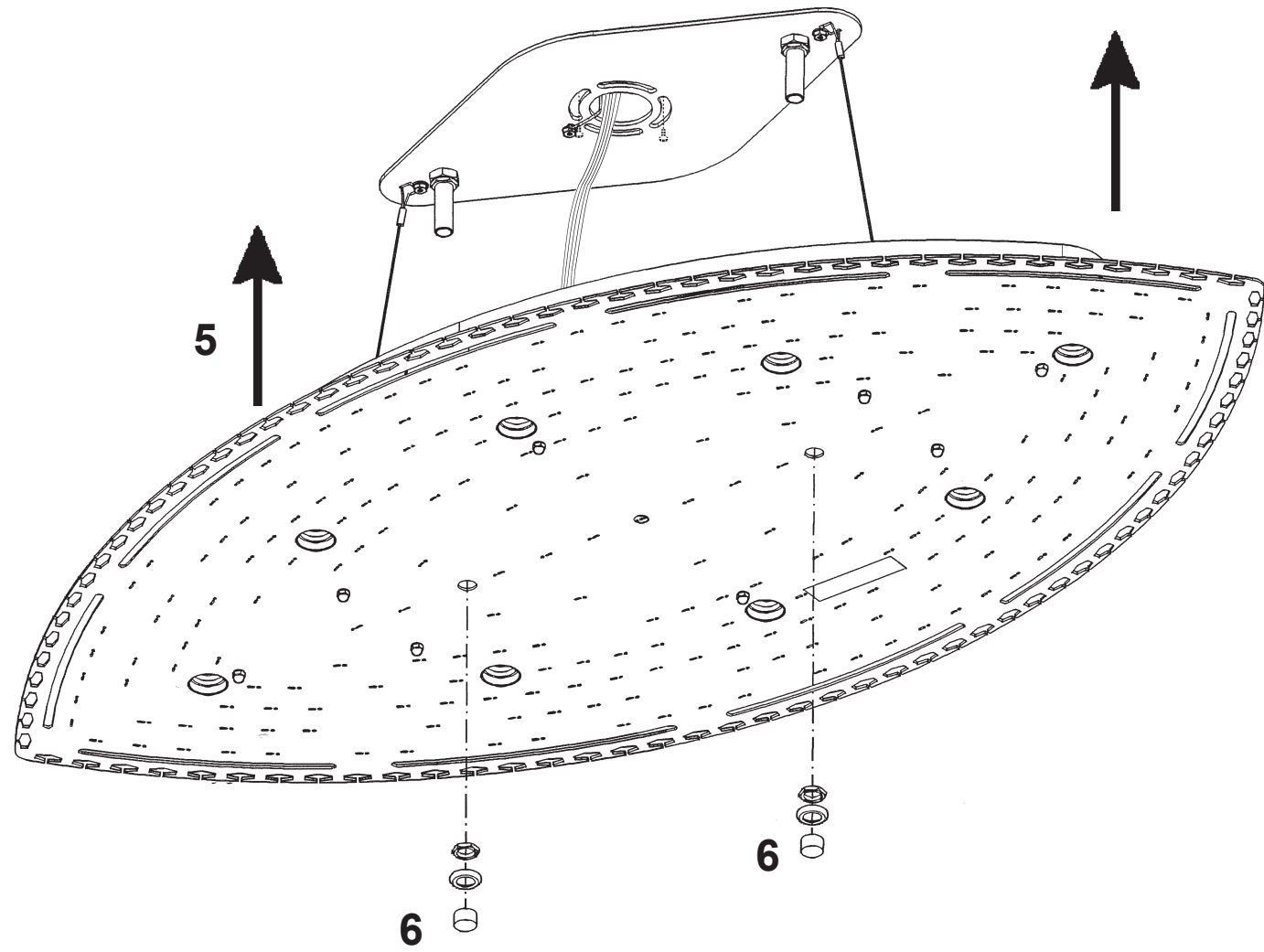
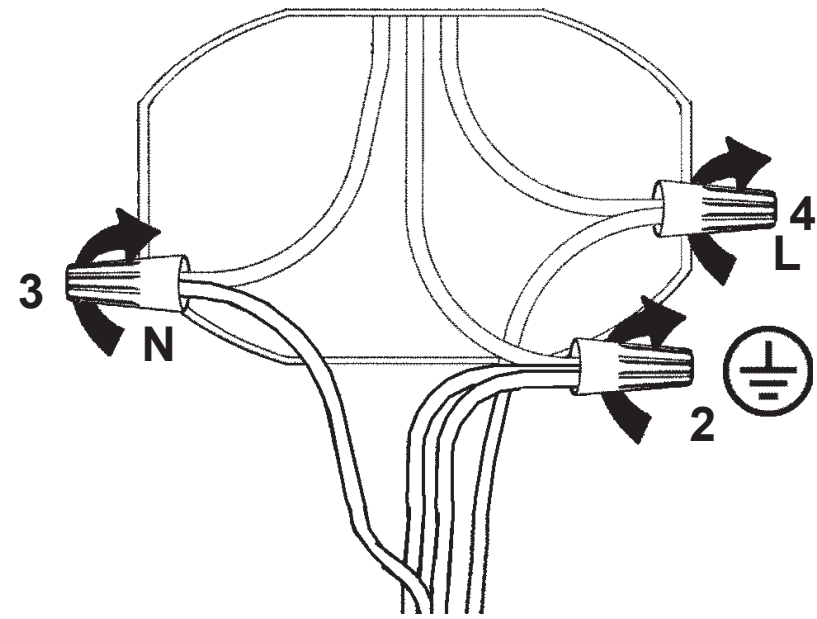

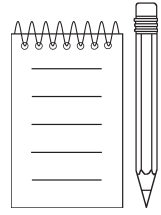

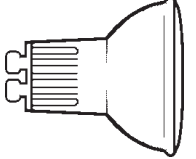

8 X  : GU10 35W MAX 

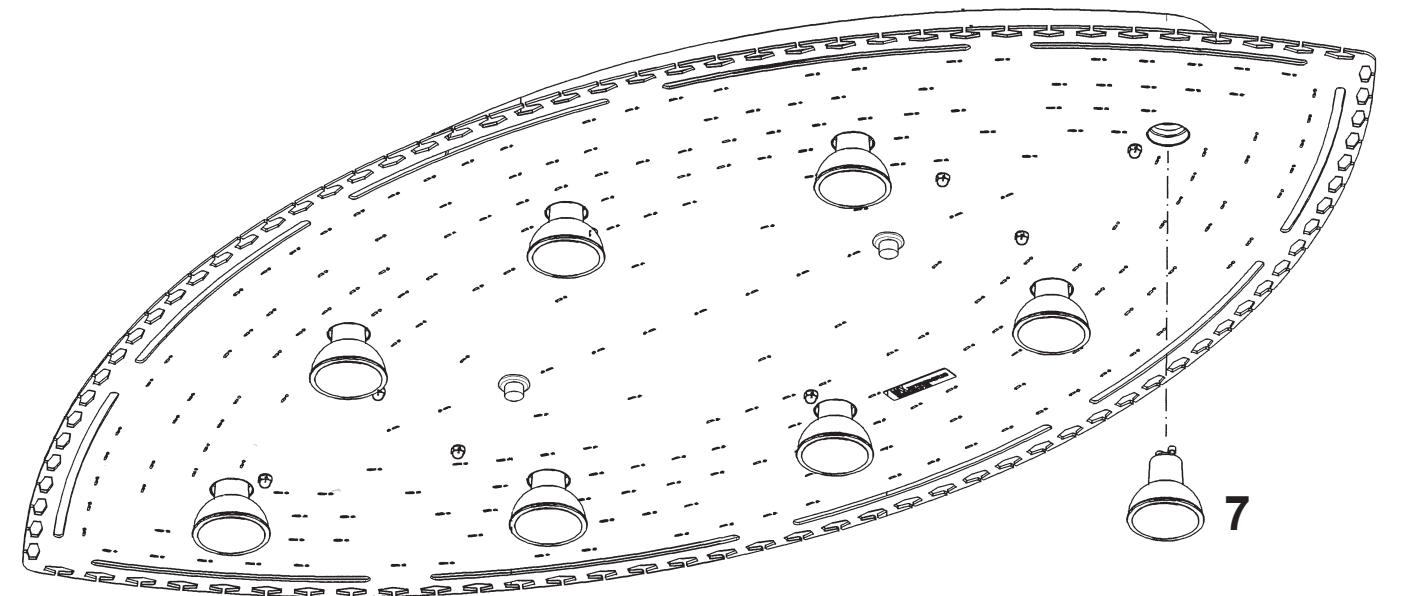

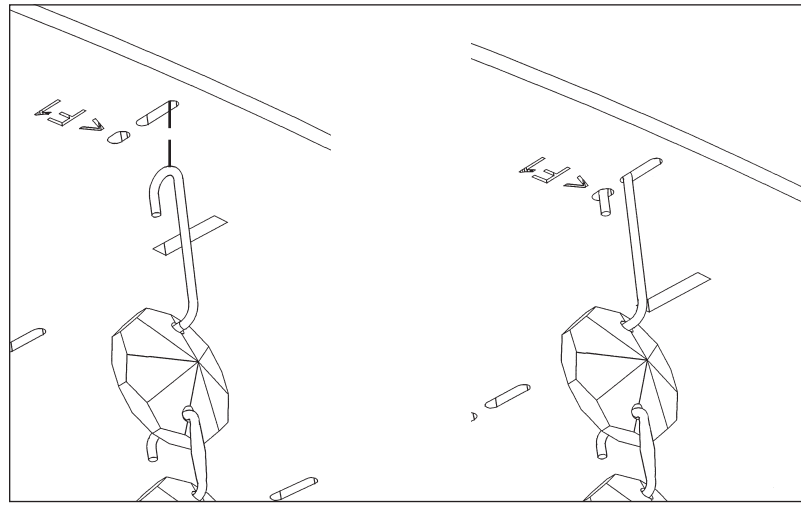
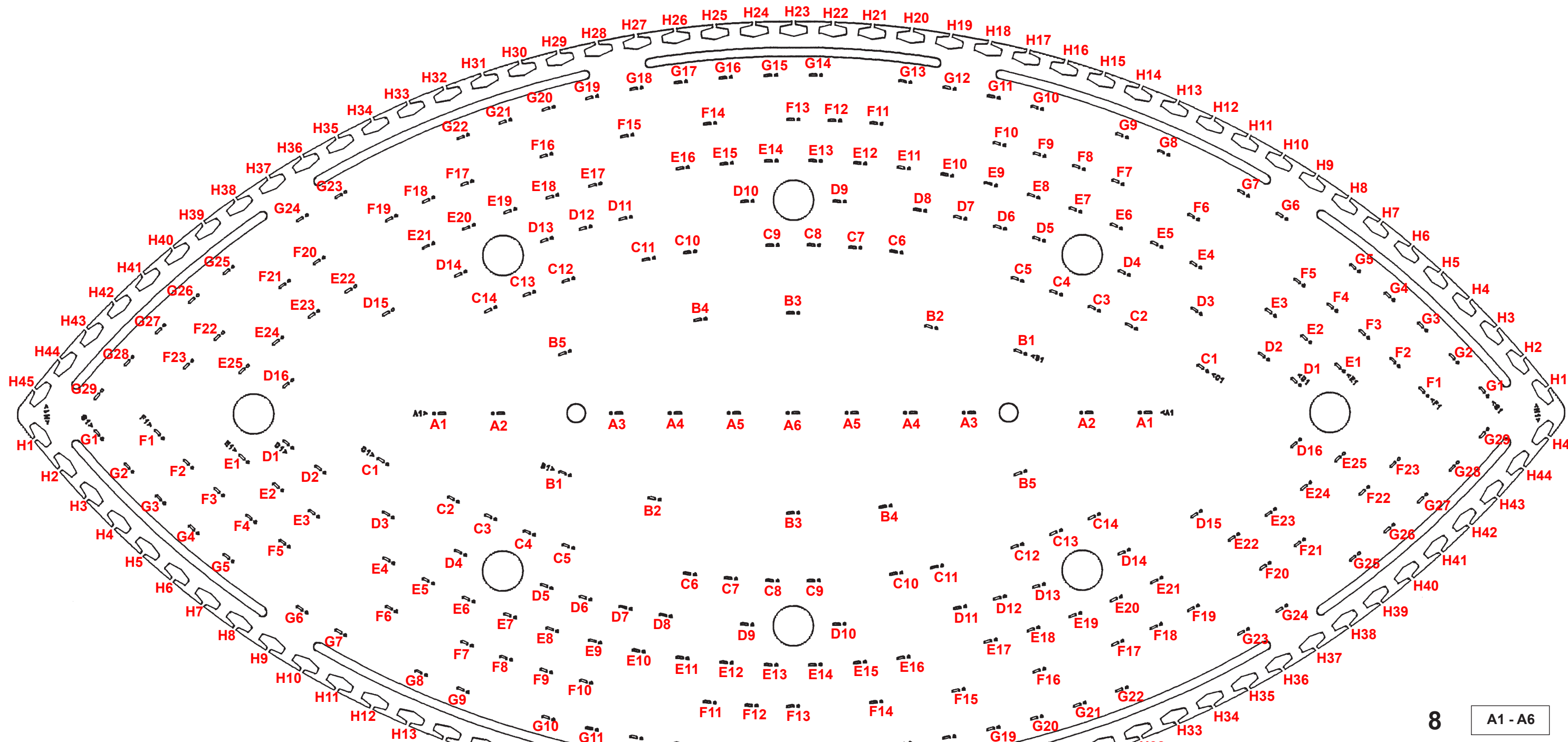

After hanging all trim, remove labels from crystals. If residue remains, wipe off crystal with a soft, dry cloth.

- 8 A1 - A6
- 9 B1 - B5
- 10 C1 - C14
- 11 D1 - D16
- 12 E1 - E25
- 13 F1 - F23
- 14 G1 - G29
- 15 H1 - H45

 **SCHONBEK** | 1870











CHANTANT CH4803N- __ _R



THIS DESIGN IS THE PROPRIETARY
TRADE DRESS/TRADEMARK OF
W SCHONBEK LLC.

8 Lights
Height: 52-1/2"
Length: 43"
Width: 22"
Hanging Weight: 61lbs.

 **SCHONBEK** | 1870

			S						
MAX 35 W	110-120 V								

NOTE: INSTALLER IS SOLELY RESPONSIBLE FOR PROPER MOUNTING!

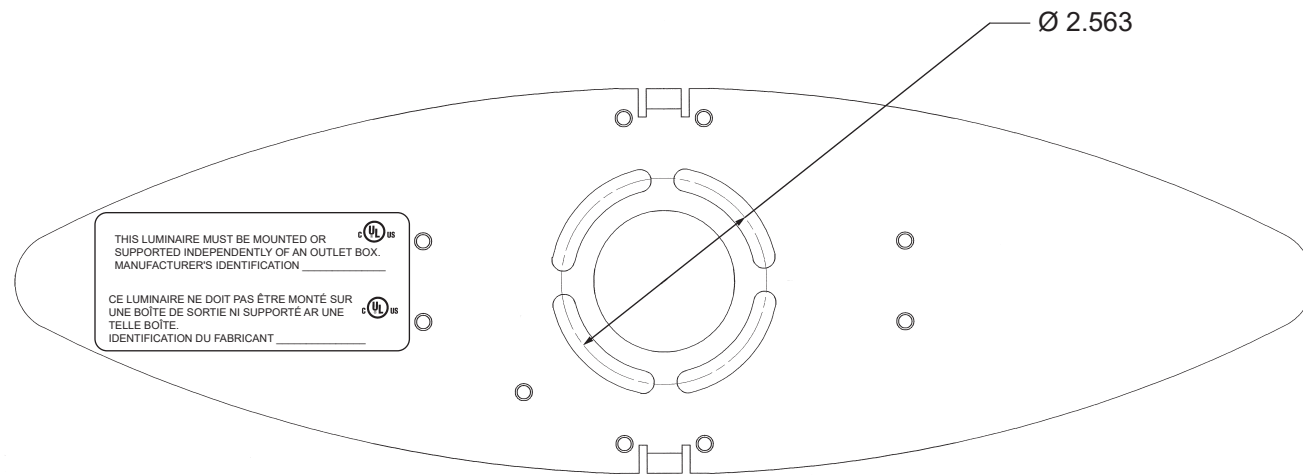

PLAN VIEW OF MOUNTING BRACKET

CROSS MEMBERS SECURELY FASTENS TO JOIST OR SIMILAR STRUCTURE MEMBER

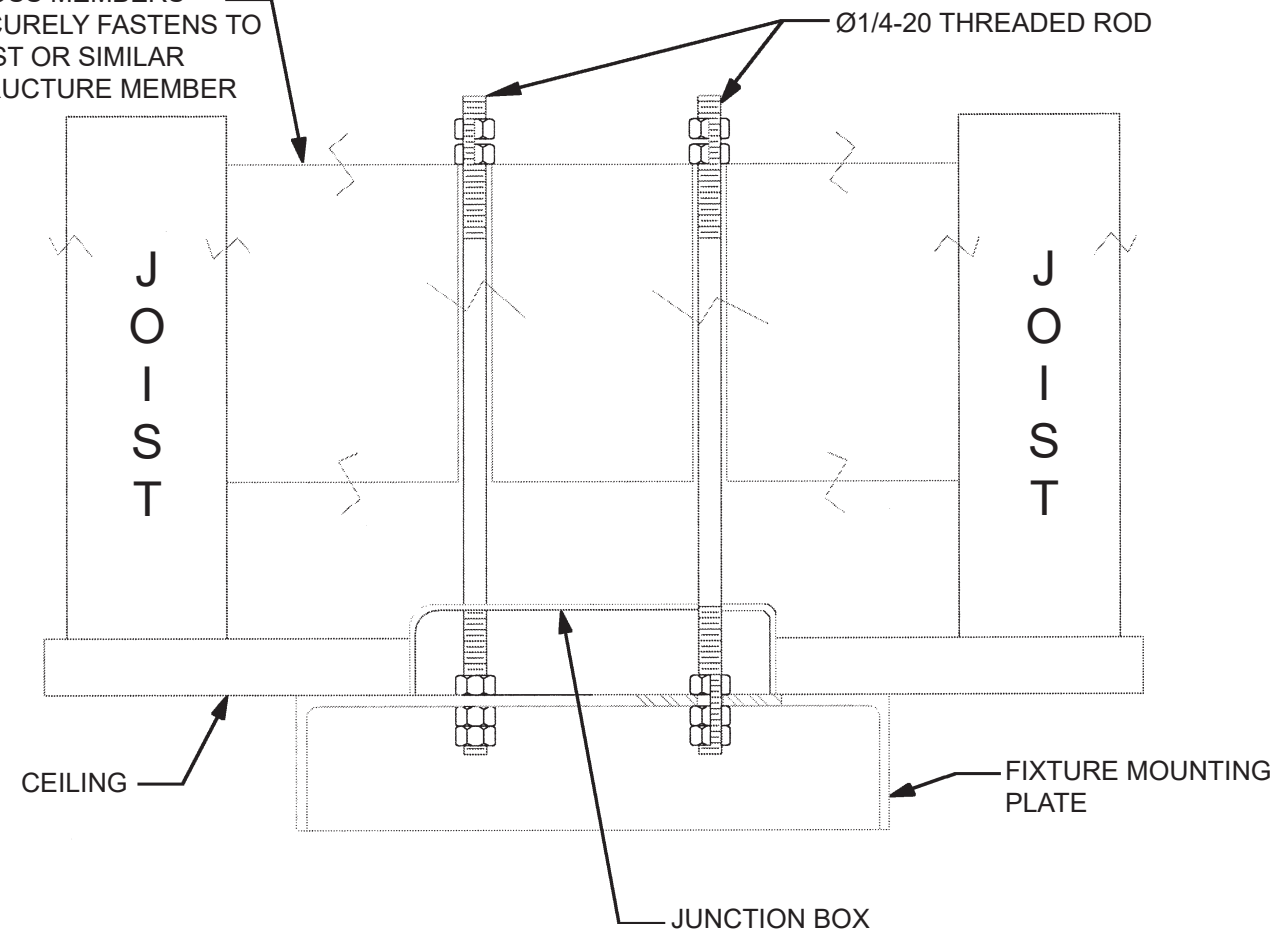

WARNING:

MOUNTING CONFIGURATION AND HARDWARE MUST HOLD 4X THE WEIGHT OF THE FIXTURE. MOUNTING DESIGN AND FIXTURE INSTALLATION SHOULD BE CONDUCTED BY A QUALIFIED LICENSED PROFESSIONAL.

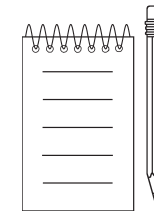

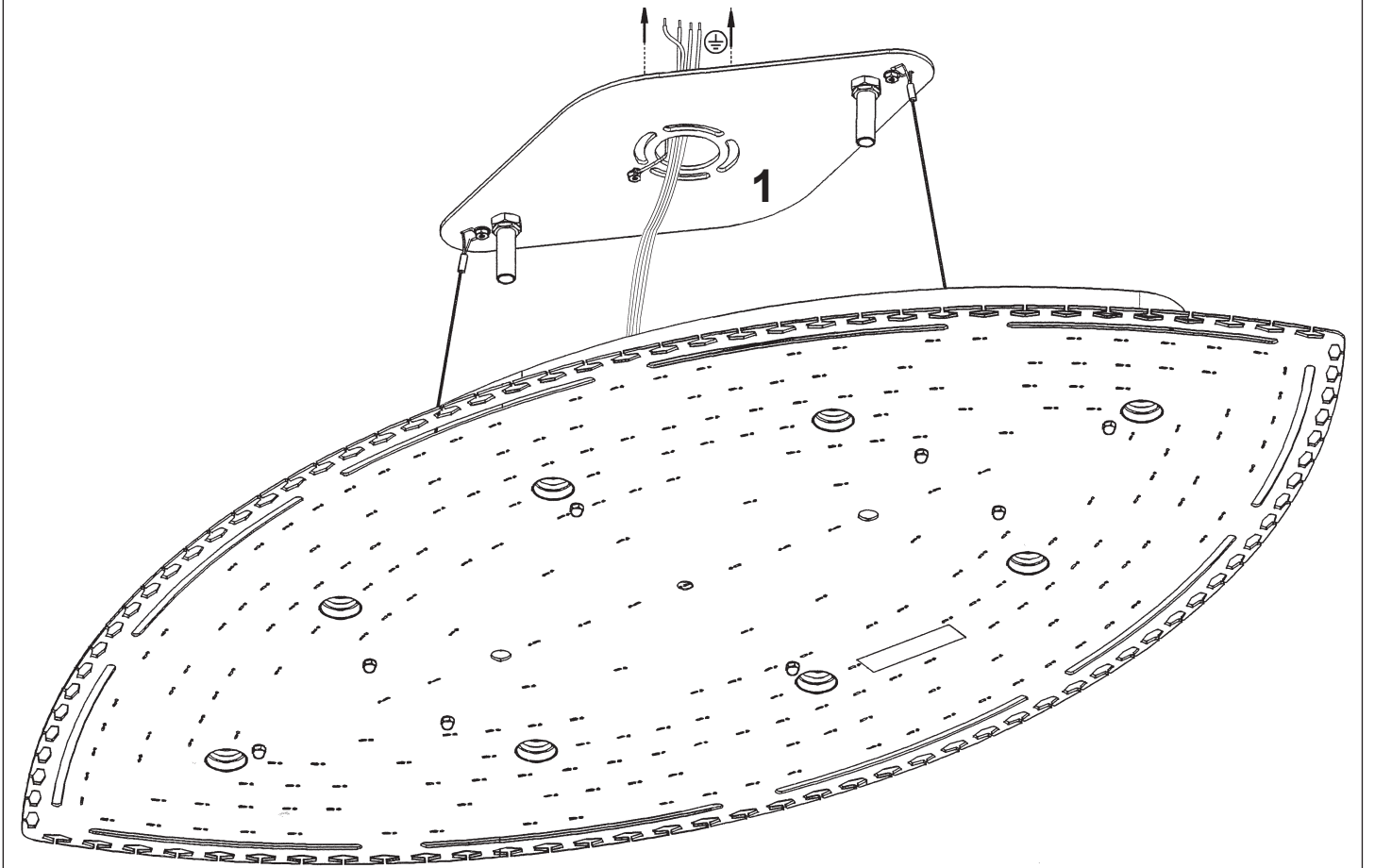
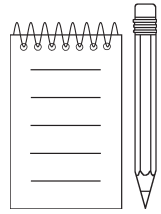

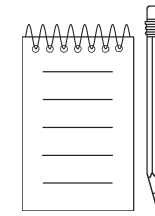
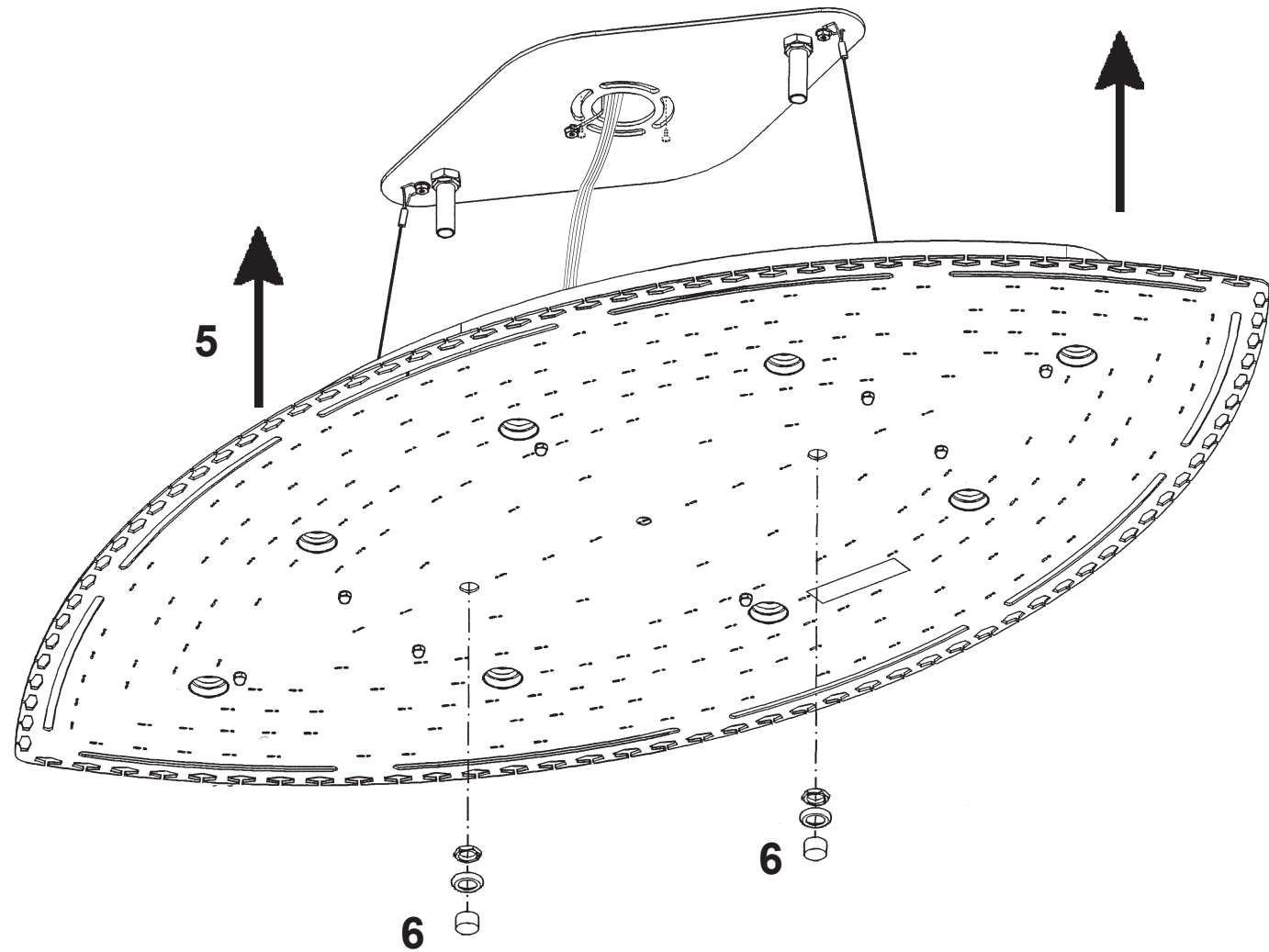
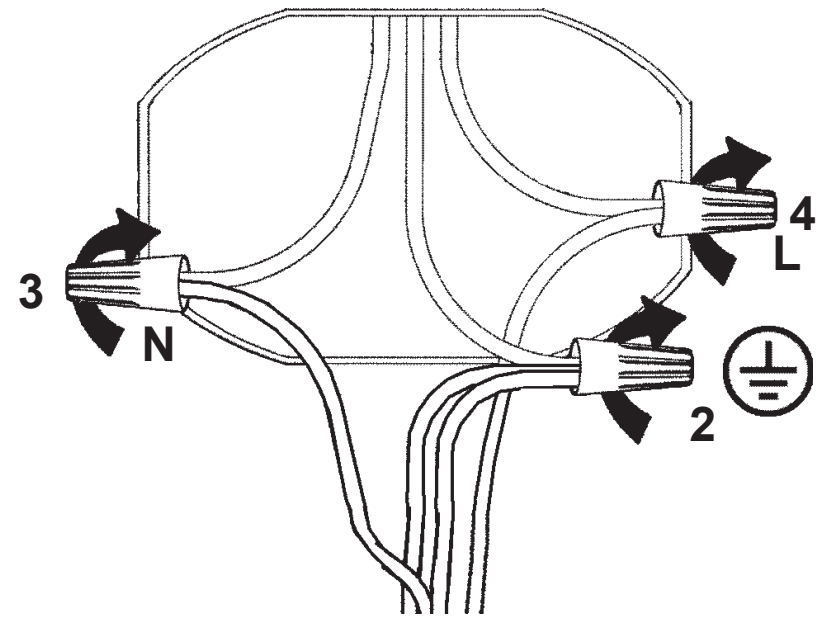

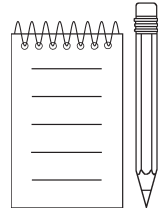

8 X  : GU10 35W MAX 

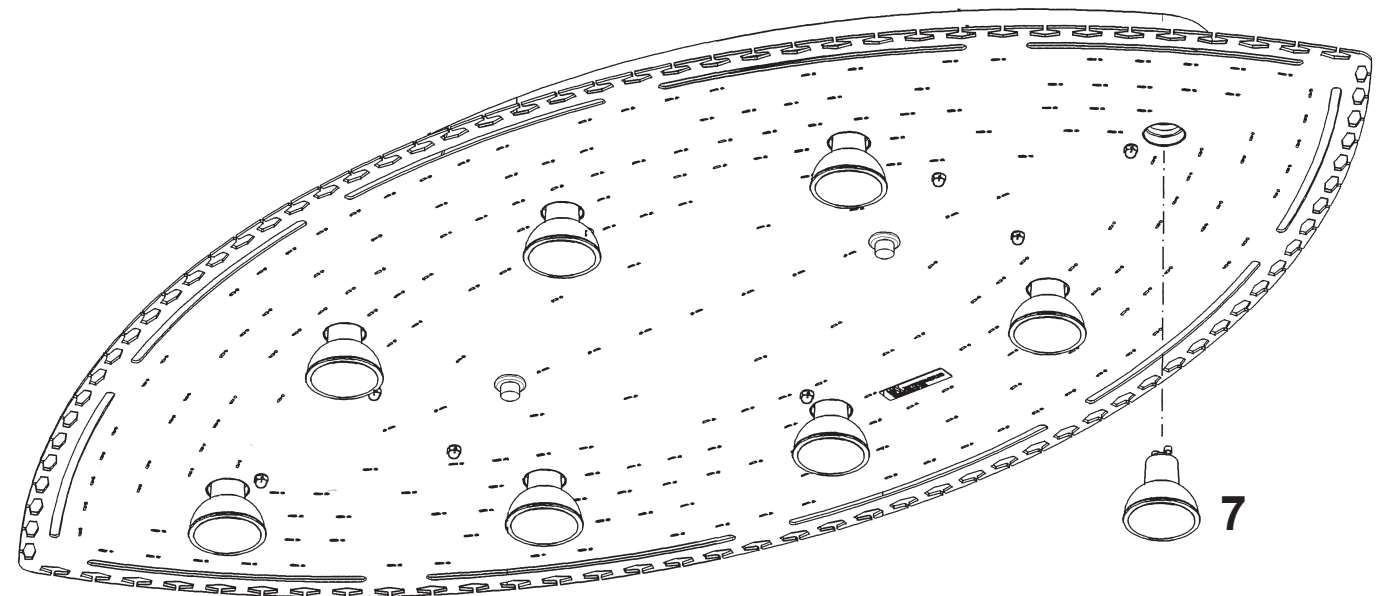

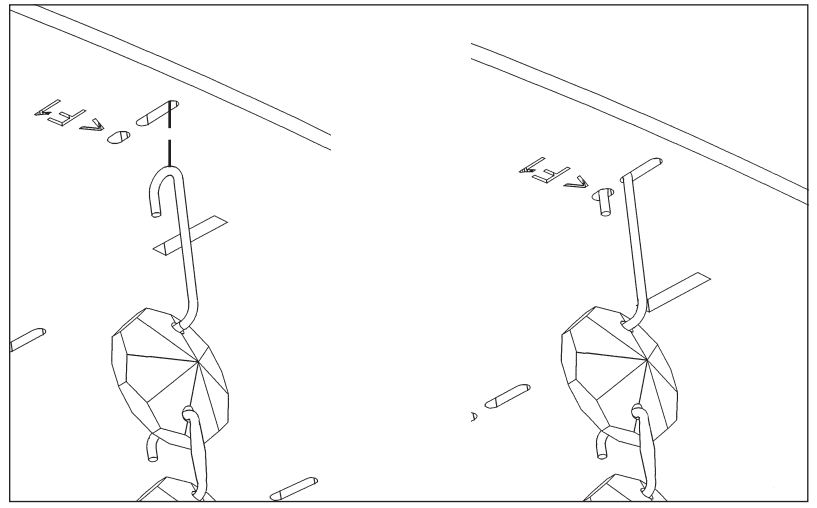
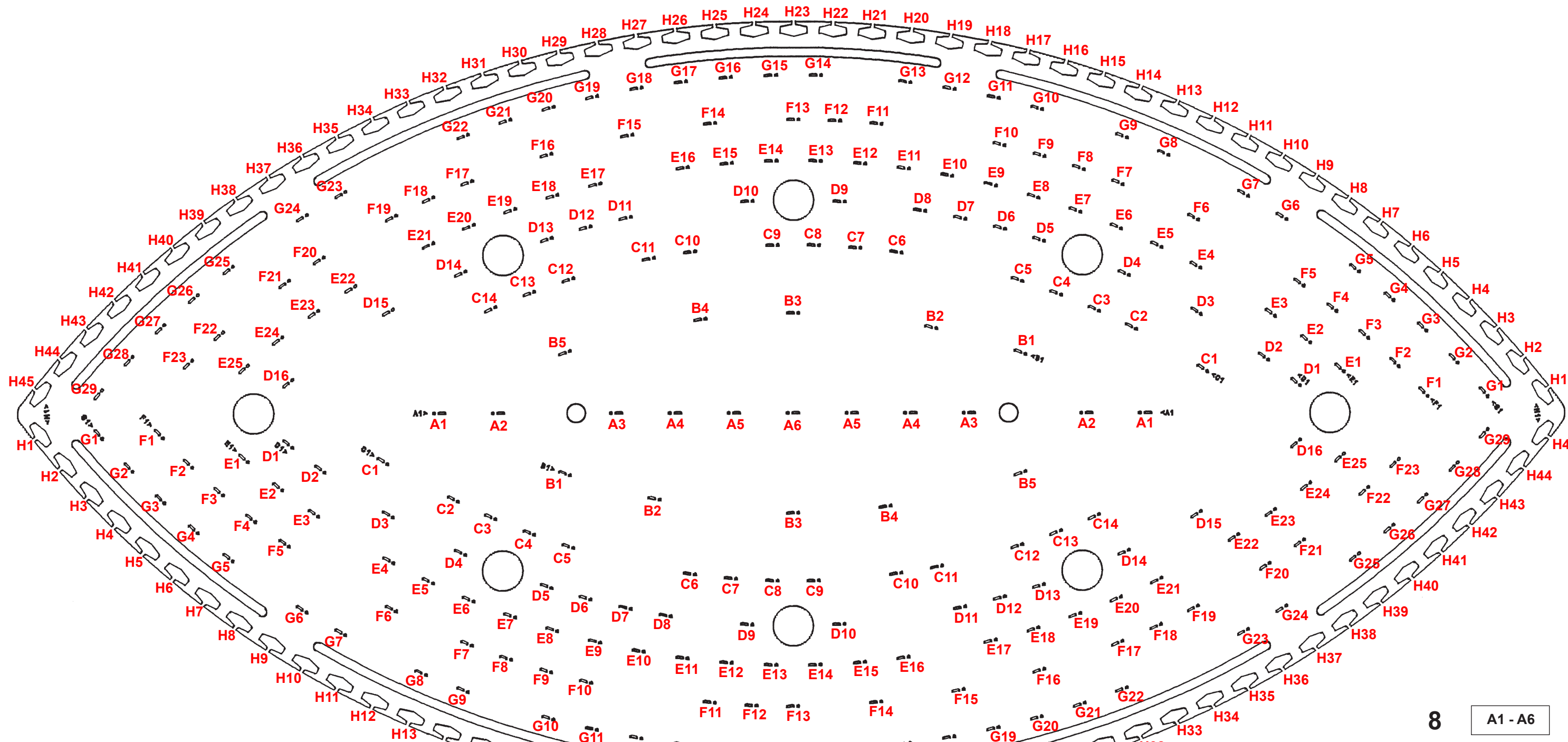

After hanging all trim, remove labels from crystals. If residue remains, wipe off crystal with a soft, dry cloth.

- 8 A1 - A6
- 9 B1 - B5
- 10 C1 - C14
- 11 D1 - D16
- 12 E1 - E25
- 13 F1 - F23
- 14 G1 - G29
- 15 H1 - H45